

# Zener Voltage Regulators

225 mW SOT-23 Surface Mount

## LBZX84B2V0LT1G SERIES

### FEATURES

- Non-wire bonding structure improves
- High demand voltage range (3.6V-36V)
- This is a Pb-Free device

### CONSTRUCTION

- Silicon epitaxial planar

Pb-Free package is available

### ORDERING INFORMATION

Device	Package	Shipping
LBZX84B2V0LT1G Series	SOT-23	3000/Tape&Reel
LBZX84B2V0LT3G Series	SOT-23	10000/Tape&Reel

\*See specific marking table.

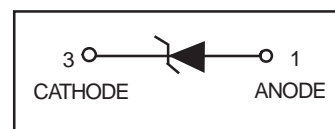
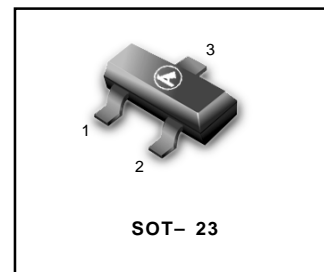

### ABSOLUTE MAXIMUM RATINGS (Ta=25°C)

Parameter	Symbol	Limits	Unit
Power dissipation	P	225	mW
Junction temperature	Tj	+125	°C
Storage temperature	Tstg	-55 to +125	°C
Operating temperature	Topr	-55 to +125	°C

### DEVICE MARKING CODE

Device	Marking	Device	Marking	Device	Marking
LBZX84B2V0LT1G	02	LBZX84B5V6LT1G	C2	LBZX84B16LT1G	55
LBZX84B2V2LT1G	12	LBZX84B6V2LT1G	E2	LBZX84B18LT1G	65
LBZX84B2V4LT1G	22	LBZX84B6V8LT1G	F2	LBZX84B20LT1G	75
LBZX84B2V7LT1G	32	LBZX84B7V5LT1G	H2	LBZX84B22LT1G	85
LBZX84B3V0LT1G	42	LBZX84B8V2LT1G	J2	LBZX84B24LT1G	95
LBZX84B3V3LT1G	52	LBZX84B9V1LT1G	L2	LBZX84B27LT1G	A5
LBZX84B3V6LT1G	62	LBZX84B10LT1G	05	LBZX84B30LT1G	C5
LBZX84B3V9LT1G	72	LBZX84B11LT1G	15	LBZX84B33LT1G	E5
LBZX84B4V3LT1G	82	LBZX84B12LT1G	25	LBZX84B36LT1G	F5
LBZX84B4V7LT1G	92	LBZX84B13LT1G	35	-	-
LBZX84B5V1LT1G	A2	LBZX84B15LT1G	45	-	-

## LBZX84B2V0LT1G SERIES

### ELECTRICAL CHARACTERISTICS (Ta=25°C)

Device	Zener voltage			Operating resistance		Rising operating resistance		Reverse current	
	V <sub>Z</sub> (V)			Z <sub>Z</sub> (Ω)		Z <sub>Zk</sub> (Ω)		I <sub>R</sub> (μA)	
	Min.	Max.	I <sub>Z</sub> (mA)	Max.	I <sub>Z</sub> (mA)	Max.	I <sub>Z</sub> (mA)	Max.	V <sub>R</sub> (V)
LBZX84B2V0LT1G	2.020	2.200	5	100	5	1000	0.5	120	0.5
LBZX84B2V2LT1G	2.220	2.410	5	100	5	1000	0.5	120	0.7
LBZX84B2V4LT1G	2.430	2.630	5	100	5	1000	0.5	100	1.0
LBZX84B2V7LT1G	2.690	2.910	5	110	5	1000	0.5	100	1.0
LBZX84B3V0LT1G	3.010	3.220	5	120	5	1000	0.5	50	1.0
LBZX84B3V3LT1G	3.320	3.530	5	120	5	1000	0.5	20	1.0
LBZX84B3V6LT1G	3.600	3.845	5	100	5	1000	1.0	10	1.0
LBZX84B3V9LT1G	3.890	4.160	5	100	5	1000	1.0	5	1.0
LBZX84B4V3LT1G	4.170	4.430	5	100	5	1000	1.0	5	1.0
LBZX84B4V7LT1G	4.550	4.750	5	100	5	800	0.5	2	1.0
LBZX84B5V1LT1G	4.980	5.200	5	80	5	500	0.5	2	1.5
LBZX84B5V6LT1G	5.490	5.730	5	60	5	200	0.5	1	2.5
LBZX84B6V2LT1G	6.060	6.330	5	60	5	100	0.5	1	3.0
LBZX84B6V8LT1G	6.650	6.930	5	40	5	60	0.5	0.5	3.5
LBZX84B7V5LT1G	7.280	7.600	5	30	5	60	0.5	0.5	4.0
LBZX84B8V2LT1G	8.020	8.360	5	30	5	60	0.5	0.5	5.0
LBZX84B9V1LT1G	8.850	9.230	5	30	5	60	0.5	0.5	6.0
LBZX84B10LT1G	9.770	10.210	5	30	5	60	0.5	0.1	7.0
LBZX84B11LT1G	10.760	11.220	5	30	5	60	0.5	0.1	8.0
LBZX84B12LT1G	11.740	12.240	5	30	5	80	0.5	0.1	9.0
LBZX84B13LT1G	12.910	13.490	5	37	5	80	0.5	0.1	10.0
LBZX84B15LT1G	14.340	14.980	5	42	5	80	0.5	0.1	11.0
LBZX84B16LT1G	15.850	16.510	5	50	5	80	0.5	0.1	12.0
LBZX84B18LT1G	17.560	18.350	5	65	5	80	0.5	0.1	13.0
LBZX84B20LT1G	19.520	20.390	5	85	5	100	0.5	0.1	15.0
LBZX84B22LT1G	21.540	22.470	5	100	5	100	0.5	0.1	17.0
LBZX84B24LT1G	23.720	24.780	5	120	5	120	0.5	0.1	19.0
LBZX84B27LT1G	26.190	27.530	5	150	5	150	0.5	0.1	21.0
LBZX84B30LT1G	29.190	30.690	5	200	5	200	0.5	0.1	23.0
LBZX84B33LT1G	32.150	33.790	5	250	5	250	0.5	0.1	25.0
LBZX84B36LT1G	35.070	36.870	5	300	5	300	0.5	0.1	27.0

Notes) 1. The Zener voltage (V<sub>Z</sub>) is measured 40ms after power is supplied.

2. The operating resistances (Z<sub>Z</sub>, Z<sub>Zk</sub>) are measured by superimposing a minute alternating current on the regulated current (I<sub>Z</sub>).

# LBZX84B2V0LT1G SERIES

## ELECTRICAL CHARACTERISTIC CURVES (Ta=25°C)

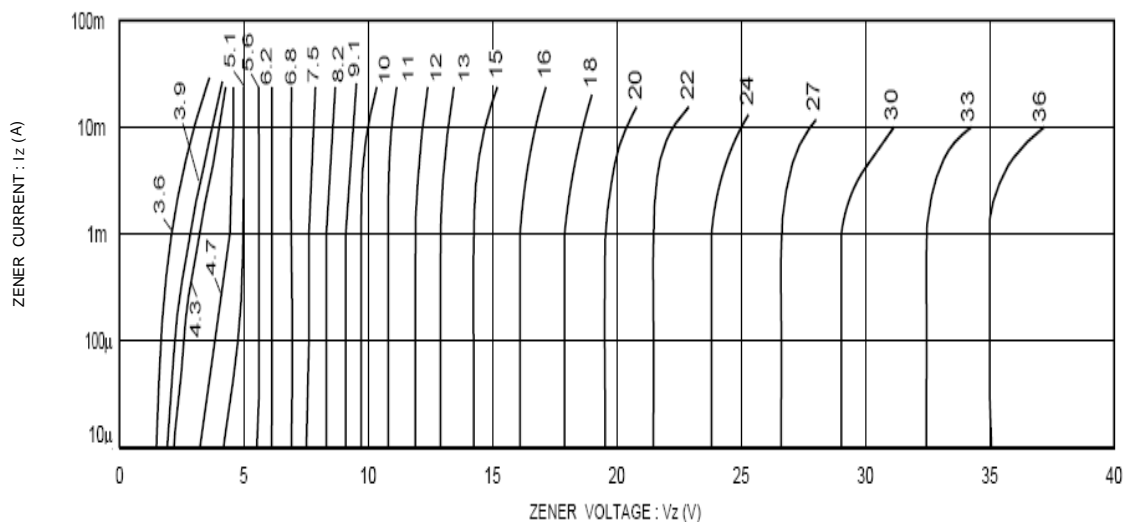

Fig.1 Zener voltage characteristics

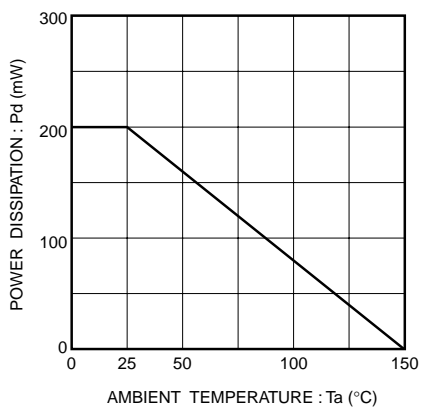

Fig.2 Derating curve

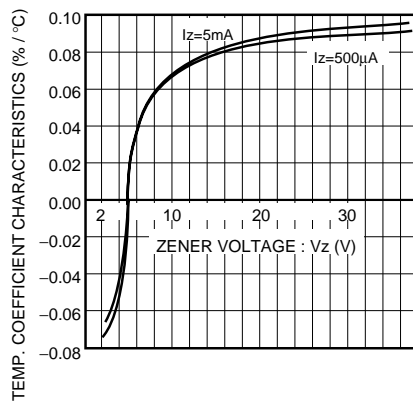

Fig.3 Zener voltage-temp. coefficient characteristics

# LBZX84B2V0LT1G SERIES

## SOT-23

NOTES:

1. DIMENSIONING AND TOLERANCING PER ANSI Y14.5M,1982
2. CONTROLLING DIMENSION: INCH.

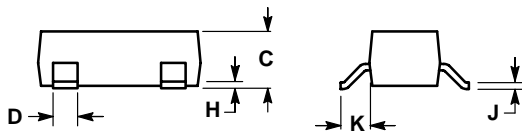
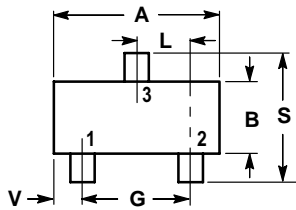

DIM	INCHES		MILLIMETERS	
	MIN	MAX	MIN	MAX
A	0.1102	0.1197	2.80	3.04
B	0.0472	0.0551	1.20	1.40
C	0.0350	0.0440	0.89	1.11
D	0.0150	0.0200	0.37	0.50
G	0.0701	0.0807	1.78	2.04
H	0.0005	0.0040	0.013	0.100
J	0.0034	0.0070	0.085	0.177
K	0.0140	0.0285	0.35	0.69
L	0.0350	0.0401	0.89	1.02
S	0.0830	0.1039	2.10	2.64
V	0.0177	0.0236	0.45	0.60

- PIN 1. BASE  
 2. EMITTER  
 3. COLLECTOR

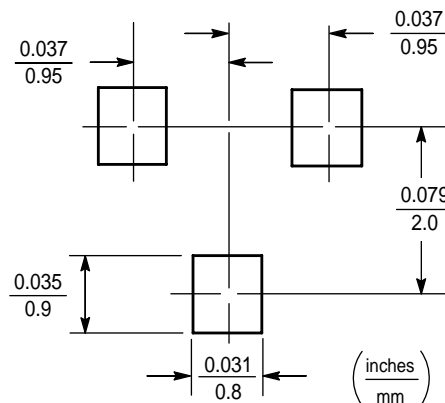

## Tape & Reel and Packaging Specifications for Small-Signal Transistors, FETs and Diodes

Embossed Tape and Reel is used to facilitate automatic pick and place equipment feed requirements. The tape is used as the shipping container for various products and requires a minimum of handling. The antistatic/conductive tape provides a secure cavity for the product when sealed with the “peel-back” cover tape.

- Two Reel Sizes Available (7" and 13")
- Used for Automatic Pick and Place Feed Systems
- Minimizes Product Handling
- EIA 481, -1, -2
- SOT-23, SC-70/SOT-323, SC-89, SC-88/SOT-363, SC-88A/SOT-353, SOD-323, SOD-523 in 8 mm Tape

Use the standard device title and add the required suffix as listed in the option table below (Table 1). Note that the individual reels have a finite number of devices depending on the type of product contained in the tape. Also note the minimum lot size is one full reel for each line item, and orders are required to be in increments of the single reel quantity.

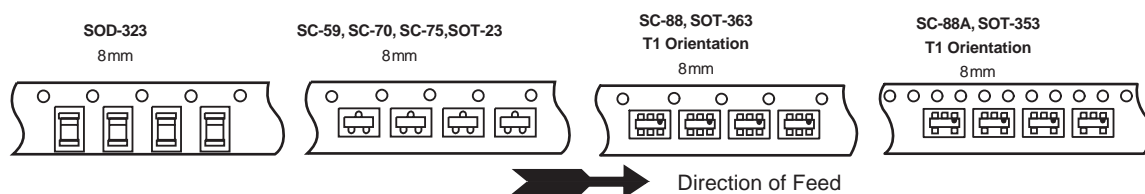

Typical Reel Orientations

Table 1. EMBOSSED TAPE AND REEL ORDERING INFORMATION

Package	Tape Width (mm)	Pitch mm	Reel Size mm(inch)	Devices Per Reel and Minimum Order Quantity	Device Suffix
SOT-23	8	4	178	(7)	3,000 T1
	8		330	(13)	10,000 T3
SC-70/SOT-323	8	4	178	(7)	3,000 T1
	8		330	(13)	10,000 T3
SC-89	8	4	178	(7)	3,000 T1
	8		330	(13)	10,000 T3
SC-88/SOT-363	8	4	178	(7)	3,000 T1
	8		330	(13)	10,000 T3
SC-88A/SOT-353	8	4	178	(7)	3,000 T1
	8		330	(13)	10,000 T3
SOD-323	8	4	178	(7)	3,000 T1
	8		330	(13)	10,000 T3
SOD-523	8	4	178	(7)	3,000 T1
	8		330	(13)	10,000 T3

## EMBOSSED TAPE AND REEL DATA FOR DISCRETES CARRIER TAPE SPECIFICATIONS

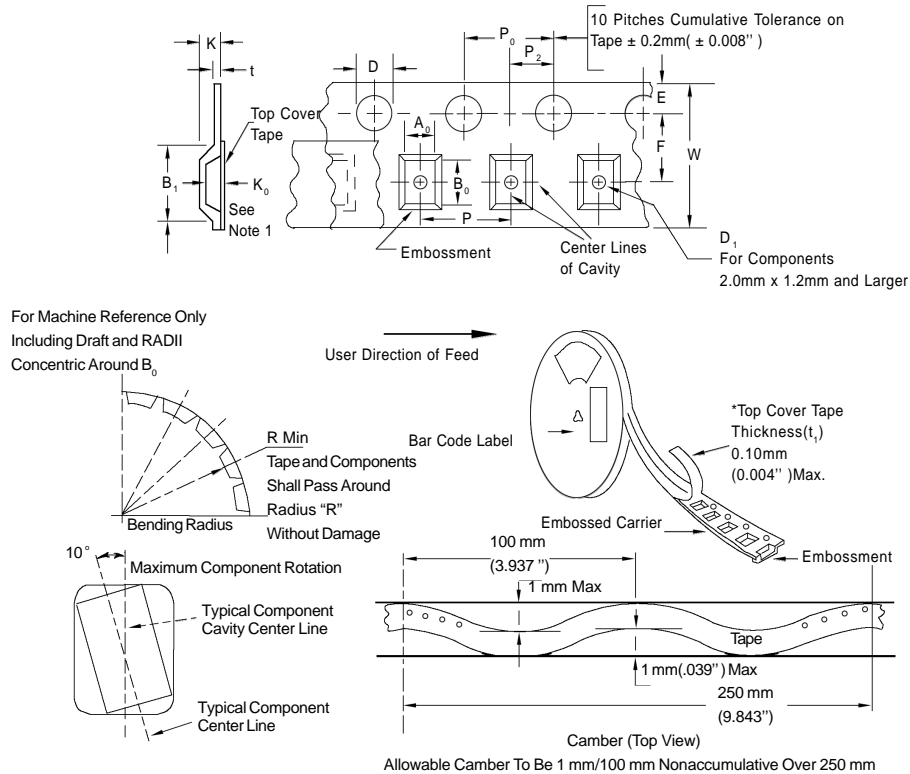

### DIMENSIONS

Tape Size	$B_1$ Max	D	$D_1$	E	F	K	$P_0$	$P_2$	RMin	TMax	WMax
8mm	4.55mm (.179")	1.5+0.1mm - 0.0	1.0Min (.039")	1.75±0.1mm (.069±.004)	3.5±0.05mm (.138±.002")	2.4mmMax (.094")	4.0 ± 0.1mm (.157 ± .004")	2.0 ± 0.1mm (.079 ± .002")	25mm (.98")	0.6mm (.024")	8.3mm (.327")
12mm	8.2mm (.323")	(.059+.004" -0.0)	1.5mmMin (.060")		5.5±0.05mm (.217±.002")	6.4mmMax (.252")			30mm (1.18")		12 ± .30mm (.470±.012")
16mm	12.1mm (.476")				7.5±0.10mm (.295±.004")	7.9mmMax (.311")					16.3mm (.642")
24mm	20.1mm (.791")				11.5±0.1mm (.453±.004")	11.9mmMax (.468")					24.3mm (.957")

Metric dimensions govern - English are in parentheses for reference only.

NOTE 1:  $A_0$ ,  $B_0$ , and  $K_0$  are determined by component size. The clearance between the components and the cavity must be within .05 mm min. to .50 mm max.,

NOTE 2: the component cannot rotate more than 10° within the determined cavity.

NOTE 3: If  $B_1$  exceeds 4.2 mm (.165") for 8 mm embossed tape, the tape may not feed through all tape feeders.

## EMBOSSED TAPE AND REEL DATA FOR DISCRETES

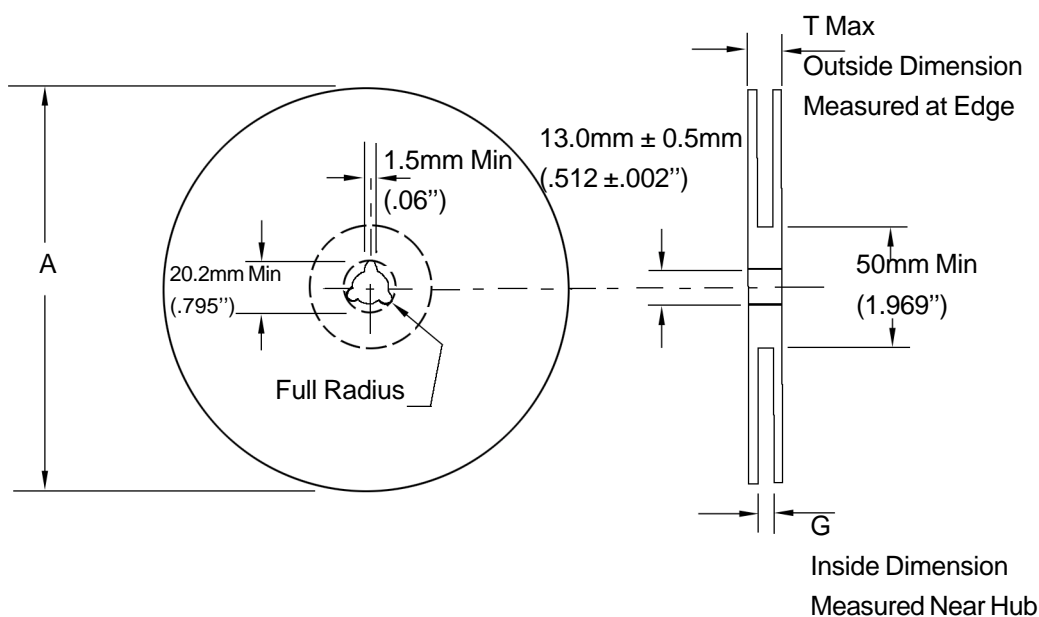

Size	A Max	G	T Max
8 mm	330mm (12.992")	8.4mm+1.5mm, -0.0 (.33"+.059", -0.00)	14.4mm (.56")
12mm	330mm (12.992")	12.4mm+2.0mm, -0.0 (.49 "+ .079", -0.00)	18.4mm (.72")
16mm	360mm (14.173")	16.4mm+2.0mm, -0.0 (.646"+.078", -0.00)	22.4mm (.882")
24 mm	360mm (14.173")	24.4mm+2.0mm, -0.0 (.961"+.070", -0.00)	30.4mm (1.197")

### Reel Dimensions

Metric Dimensions Govern — English are in parentheses for reference only

### Storage Conditions

Temperature: 5 to 40 Deg.C (20 to 30 Deg. C is preferred)

Humidity: 30 to 80 RH (40 to 60 is preferred )

Recommended Period: One year after manufacturing

(This recommended period is for the soldering condition only. The characteristics and reliabilities of the products are not restricted to this limitation)

单击下面可查看定价，库存，交付和生命周期等信息

[>>LRC\(乐山无线电\)](#)