

# LMBR360FT1G

## S-LMBR360FT1G

### Schottky Barrier Rectifiers

#### 1. FEATURES

- Plastic package has Underwriters Laboratory Flammability Classification 94V-0.
- Low power loss,high efficiency.
- For use in low voltage high frequency inverters,free wheeling,and polarity protection applications.
- Guardring for over voltage protection.
- High temperature soldering guaranteed:260°C/10 seconds at terminals.
- We declare that the material of product compliance with RoHS requirements and Halogen Free.
- S- prefix for automotive and other applications requiring unique site and control change requirements; AEC-Q101 qualified and PPAP capable.

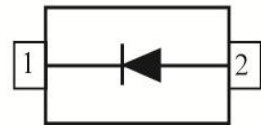
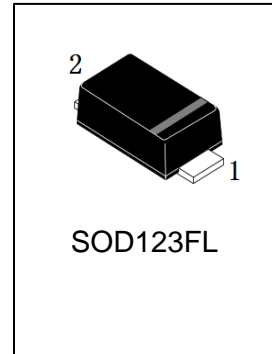

#### 2. DEVICE MARKING AND ORDERING INFORMATION

Device	Marking	Shipping
LMBR360FT1G	36	3000/Tape&Reel
S-LMBR360FT1G	36	3000/Tape&Reel

#### 3. MAXIMUM RATINGS(Ta = 25°C)

Parameter	Symbol	Limits	Unit
Maximum repetitive peak reverse voltage	VRRM	60	V
Maximum RMS voltage	VRMS	42	V
Maximum DC blocking voltage	VDC	60	V
Maximum average forward rectified current at TA = 75°C	IF(AV)	3	A
Peak forward surge current 8.3ms single half sine-wave superimposed on rated load (JEDEC Method)	IFSM	80	A
Power Dissipation	PD	400	mW
Typical thermal resistance (Note 1)	RθJA	170	°C/W
	RθJL	40	
Operating junction temperature range	TJ	-55 ~ +150	°C
storage temperature range	TSTG	-65 ~ +175	°C

Note: 1. 8.0mm<sup>2</sup> (.013mm thick) land areas

#### 4. ELECTRICAL CHARACTERISTICS (Ta= 25°C)

Characteristic	Symbol	Min	Typ.	Max	Unit
Maximum instantaneous forward voltage at 3.0A	VF	-	-	0.7	V
Maximum DC reverse current at rated DC blocking voltage TA = 25°C Tj = 100°C	IR	-	-	0.5	mA
		-	-	20	
Junction capacitance at 4.0V, 1MHz	CJ	-	155	-	pF

**5. ELECTRICAL CHARACTERISTICS CURVES**

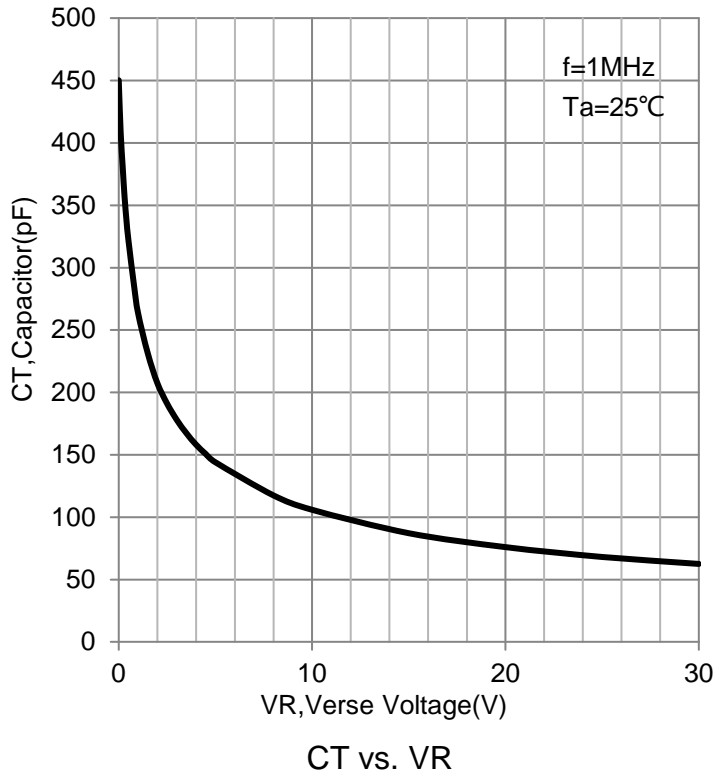
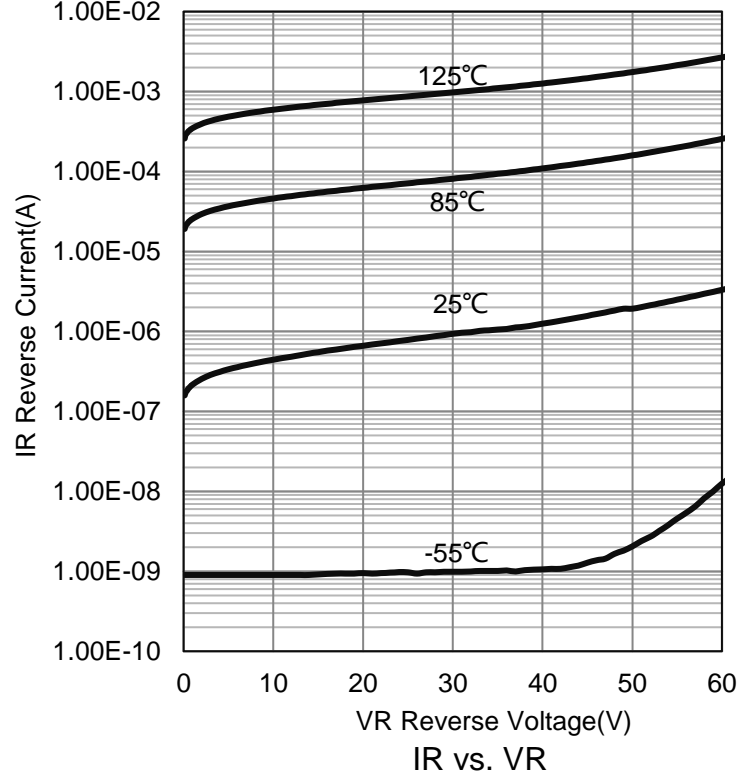
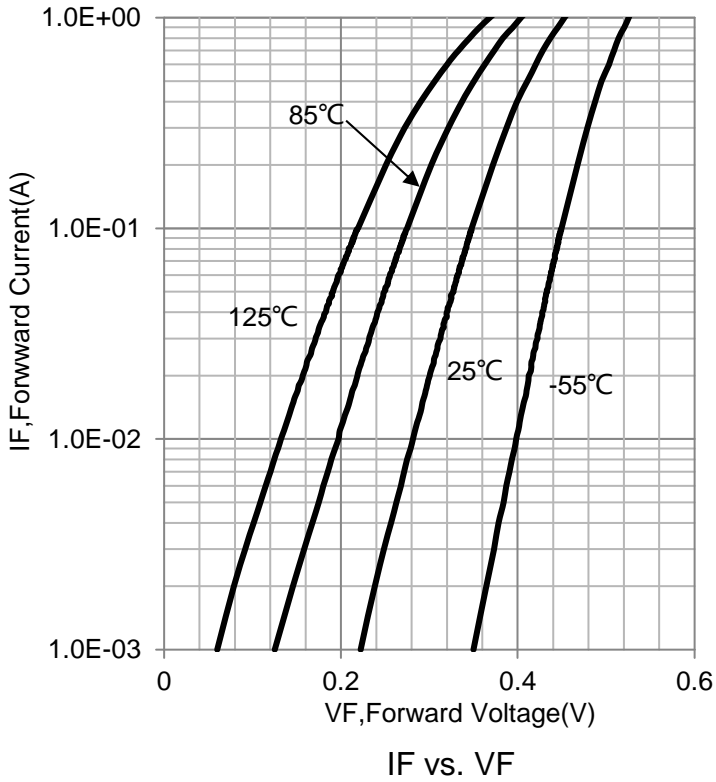

## 6. OUTLINE AND DIMENSIONS

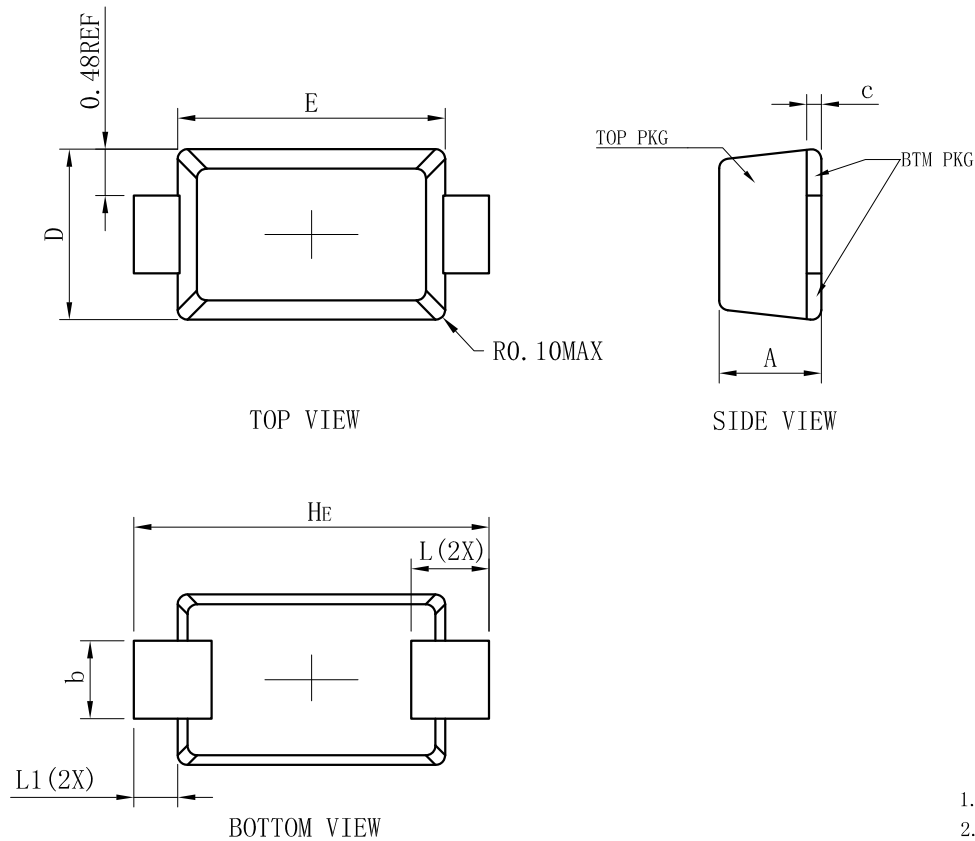

SOD123FL			
DIM	MIN	NOR	MAX
A	0.90	1.05	1.15
b	0.75	0.80	0.95
L	0.50	0.80	1.10
E	2.60	2.75	2.90
D	1.60	1.75	1.90
$H_E$	3.50	3.65	3.80
c	0.12	0.17	0.22
L1	0.25	0.45	0.65
All Dimensions in mm			

### GENERAL NOTES

1. Top package surface finish  $Ra0.4 \pm 0.2\mu\text{m}$
2. Bottom package surface finish  $Ra0.7 \pm 0.2\mu\text{m}$
3. Side package surface finish  $Ra0.4 \pm 0.2\mu\text{m}$

## 7. SOLDERING FOOTPRINT

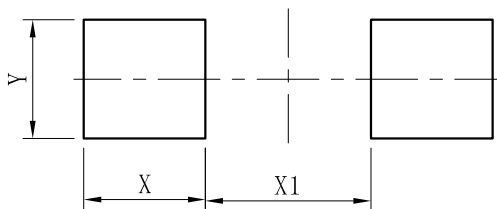

DIM	(mm)
X	1.20
Y	1.10
X1	2.00

## DISCLAIMER

- Before you use our Products, you are requested to carefully read this document and fully understand its contents. LRC shall not be in any way responsible or liable for failure, malfunction or accident arising from the use of any LRC's Products against warning, caution or note contained in this document.
- All information contained in this document is current as of the issuing date and subject to change without any prior notice. Before purchasing or using LRC's Products, please confirm the latest information with a LRC sales representative.

单击下面可查看定价，库存，交付和生命周期等信息

[>>LRC\(乐山无线电\)](#)