

# LP2371LT1G

## S-LP2371LT1G

P-Channel 100-V (D-S) MOSFET

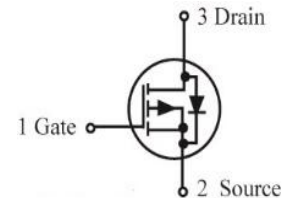
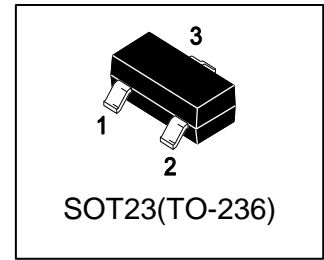

### 1. FEATURES

- $R_{DS(ON)} \leq 1.4\Omega$ ,  $V_{GS@-10V}$
- $R_{DS(ON)} \leq 1.5\Omega$ ,  $V_{GS@-4.5V}$
- Fast switching speed
- Low  $R_{DS(on)}$  trench technology
- We declare that the material of product compliance with RoHS requirements and Halogen Free.
- S- prefix for automotive and other applications requiring unique site and control change requirements; AEC-Q101 qualified and PPAP capable.

### 2. APPLICATIONS

- PoE Power Sourcing Equipment
- PoE Powered Devices
- Telecom DC/DC converters
- White LED boost converters

### 3. DEVICE MARKING AND ORDERING INFORMATION

Device	Marking	Shipping
LP2371LT1G	E9	3000/Tape&Reel
LP2371LT3G	E9	10000/Tape&Reel

### 4. MAXIMUM RATINGS( $T_a = 25^\circ\text{C}$ )

Parameter	Symbol	Limits	Unit
Drain-Source Voltage	VDSS	-100	V
Gate-to-Source Voltage – Continuous	VGS	$\pm 20$	V
Continuous Drain Current(Note 1)	ID	$T_a=25^\circ\text{C}$	-1
		$T_a=70^\circ\text{C}$	-0.8
Pulsed Drain Current(Note 2)	IDM	-2.6	A
Power Dissipation(Note 1)	PD	$T_a=25^\circ\text{C}$	1.3
		$T_a=70^\circ\text{C}$	0.8
Junction Temperature	Tj	150	$^\circ\text{C}$
Storage Temperature Range	Tstg	-55~+150	$^\circ\text{C}$
Thermal Resistance-Junction to Ambient(Note 1)	R $\theta$ JA	$t \leq 10\text{s}$	100
		Steady State	166

1.Surface mounted on "1.5 x 1.5" FR4 board using 1 sq in pad, 2 oz Cu.

2.Pulse width limited by maximum junction temperature.

**5. ELECTRICAL CHARACTERISTICS (Ta= 25°C)**

Characteristic	Symbol	Min.	Typ.	Max.	Unit
<b>STATIC</b>					
Drain–Source Breakdown Voltage (VGS = 0, ID = -250μA)	VBRDSS	-100	-	-	V
Gate Threshold Voltage (VDS = VGS, ID = -250μA)	VGS(th)	-1	-	-3.5	V
Gate Leakage Current (VDS = 0V, VGS = ±20V)	IGSS	-	-	±100	nA
Zero Gate Voltage Drain Current (VGS = 0V, VDS = -80 V) (VGS = 0V, VDS = -80 V, TJ = 55°C)	IDSS	-	-	-1 -25	μA
Static Drain–Source On–State Resistance(Note 3) (VGS = -10 V, ID = -1 A) (VGS = -4.5 V, ID = -0.9 A)	RDS(on)	-	-	1.4 1.5	Ω
Diode Forward Voltage (VGS = 0 V, IS = -0.8 A)	VSD	-	-0.81	-1.3	V
<b>DYNAMIC</b>					
Total Gate Charge (VGS = -4.5 V, ID = -1A, VDS = -50 V)	Qg	-	4	-	nC
Gate–Source Charge (VGS = -4.5 V, ID = -1A, VDS = -50 V)	Qgs	-	1.6	-	
Gate–Drain Charge (VGS = -4.5 V, ID = -1A, VDS = -50 V)	Qgd	-	1.2	-	
Input Capacitance (VGS = 0 V, f = 1.0MHz, VDS = -15 V)	Ciss	-	472	-	pF
Output Capacitance (VGS = 0 V, f = 1.0MHz, VDS = -15 V)	Coss	-	18.6	-	
Reverse Transfer Capacitance (VGS = 0 V, f = 1.0MHz, VDS = -15 V)	Crss	-	14.4	-	
Turn-On Delay Time	(VDD = -50V, RL = 50Ω ID = -1A, VGEN = -10V RG = 6.2Ω)	td(on)	-	3.6	ns
Rise Time		tr	-	1.1	
Turn-Off Delay Time		td(off)	-	19.9	
Fall Time		tf	-	1.9	

3. Pulse Test: Pulse Width ≤ 300 μs, Duty Cycle ≤ 2.0%.

**6. ELECTRICAL CHARACTERISTICS CURVES**

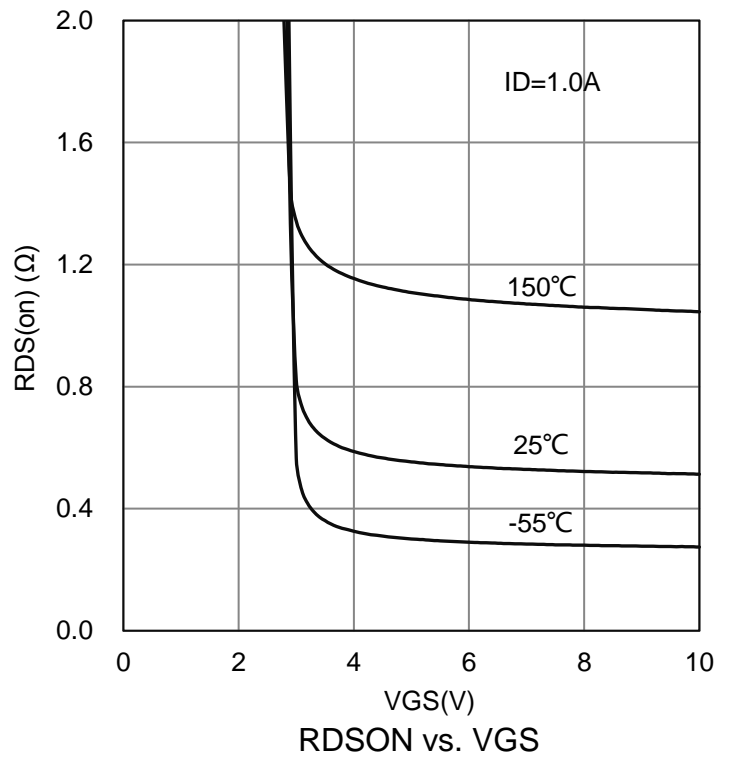
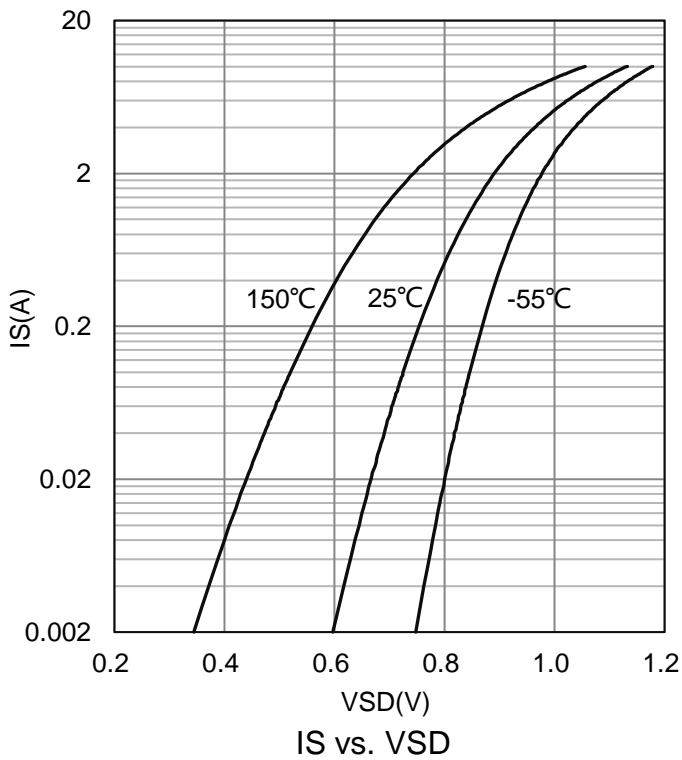
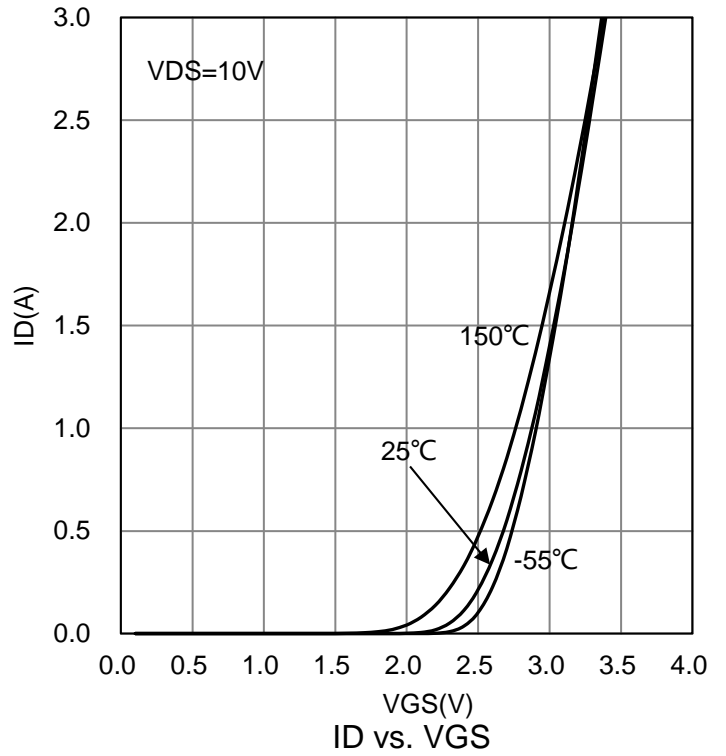
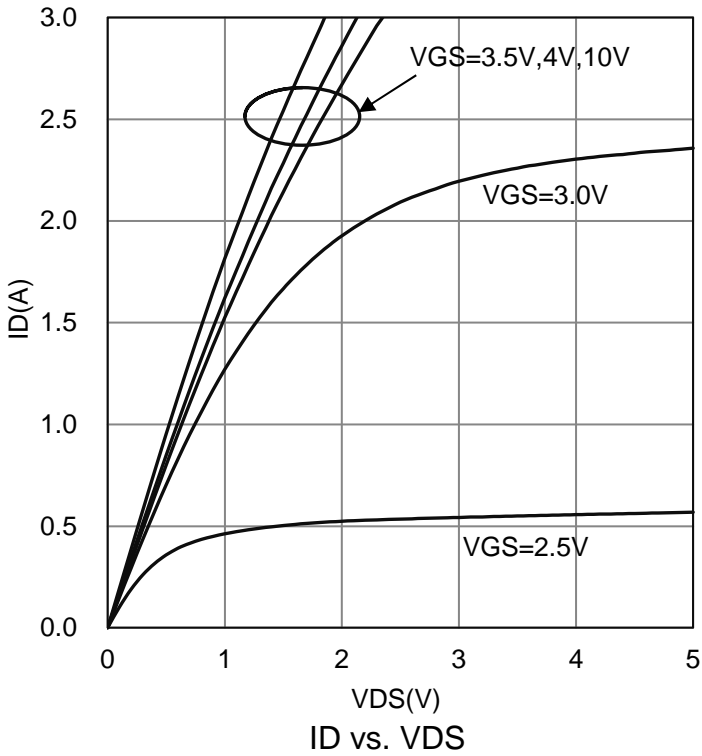

**6. ELECTRICAL CHARACTERISTICS CURVES(Con.)**

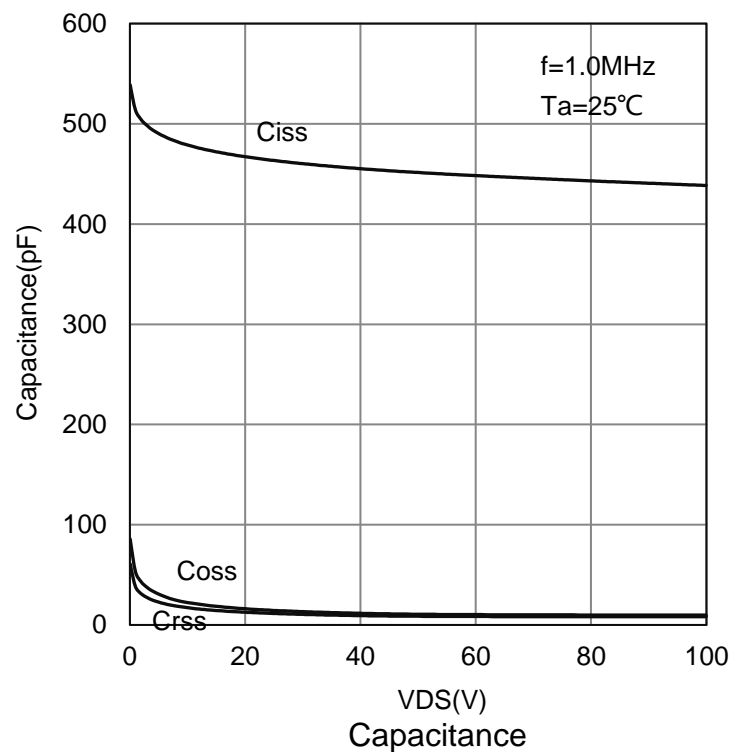
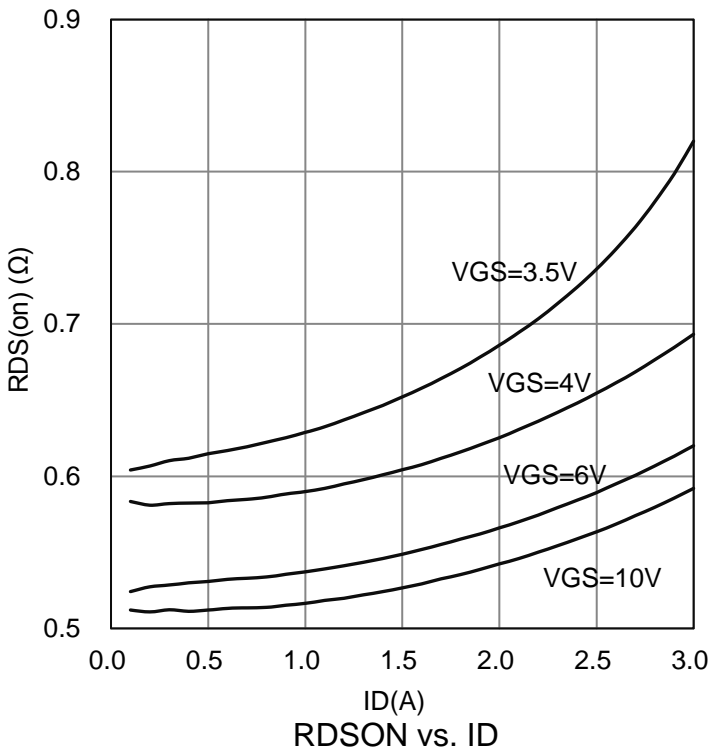
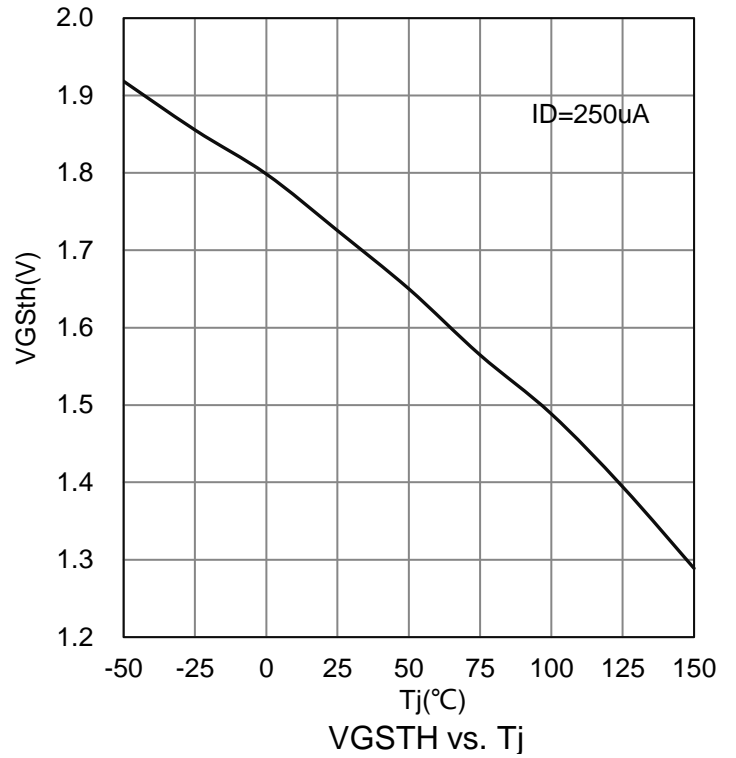
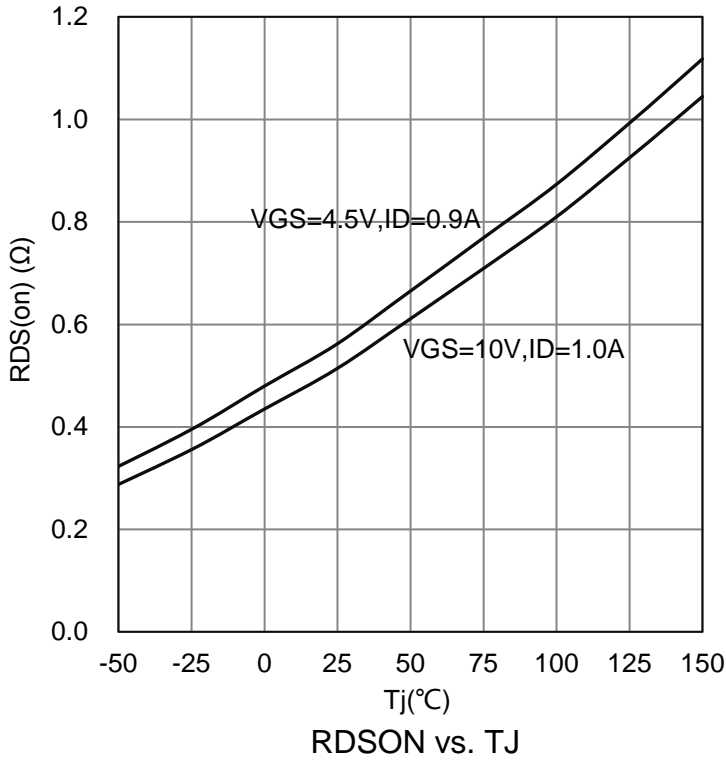

**6. ELECTRICAL CHARACTERISTICS CURVES(Con.)**

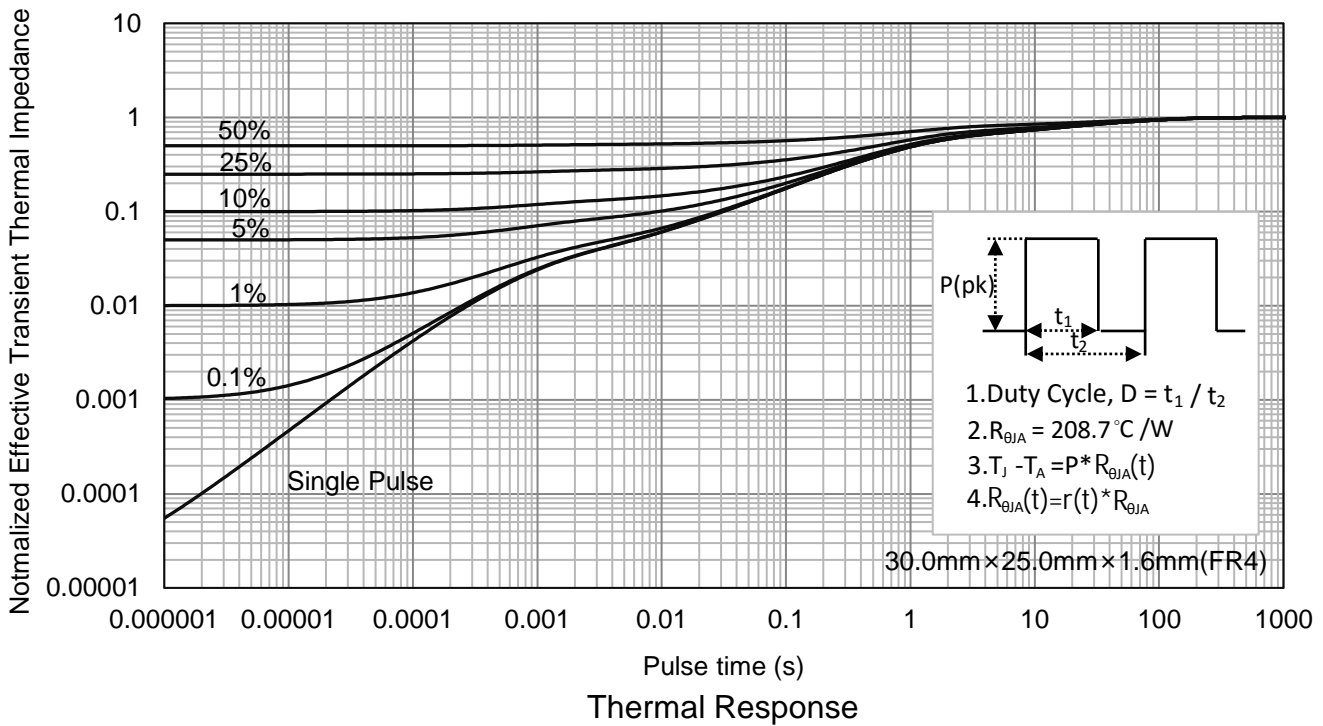
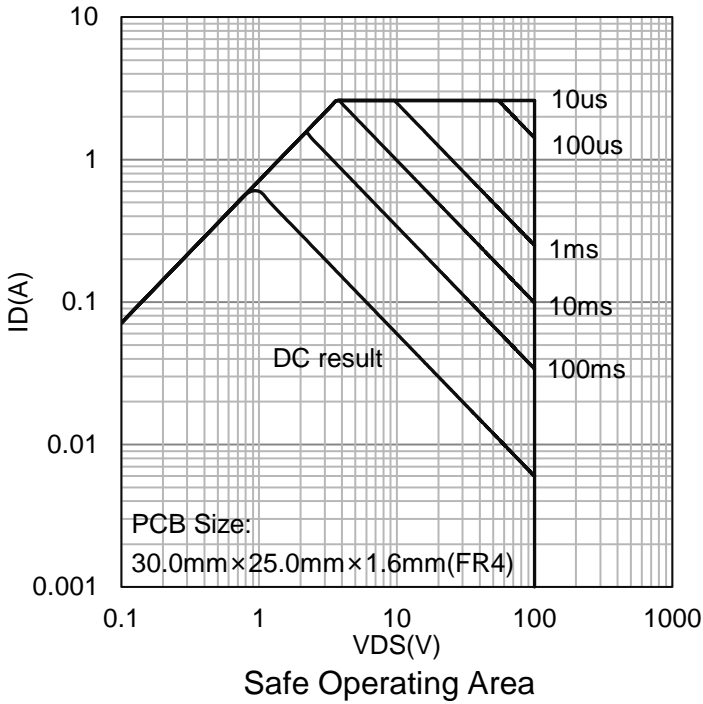

### 7. OUTLINE AND DIMENSIONS

Notes:

1. DIMENSIONING AND TOLERANCING PER ANSI Y14.5M, 1982.
2. CONTROLLING DIMENSION: MILLIMETERS.
3. MAXIMUM LEAD THICKNESS INCLUDES LEAD FINISH. MINIMUM LEAD THICKNESS IS THE MINIMUM THICKNESS OF BASE MATERIAL.
4. DIMENSIONS D AND E DO NOT INCLUDE MOLD FLASH, PROTRUSIONS OR GATE BURRS.

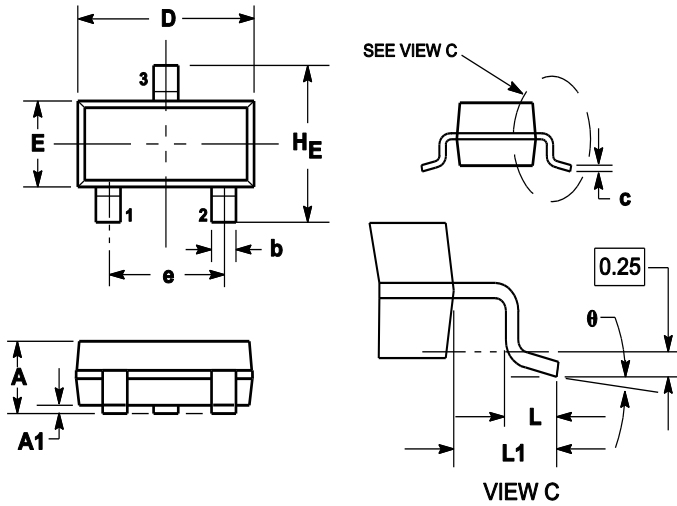

DIM	MILLIMETERS			INCHES		
	MIN	NOM	MAX	MIN	NOM	MAX
A	0.89	1	1.11	0.035	0.04	0.044
A1	0.01	0.06	0.1	0.001	0.002	0.004
b	0.37	0.44	0.5	0.015	0.018	0.02
c	0.09	0.13	0.18	0.003	0.005	0.007
D	2.80	2.9	3.04	0.11	0.114	0.12
E	1.20	1.3	1.4	0.047	0.051	0.055
e	1.78	1.9	2.04	0.07	0.075	0.081
L	0.10	0.2	0.3	0.004	0.008	0.012
L1	0.35	0.54	0.69	0.014	0.021	0.029
HE	2.10	2.4	2.64	0.083	0.094	0.104
θ	0°	---	10°	0°	---	10°

### 8. SOLDERING FOOTPRINT

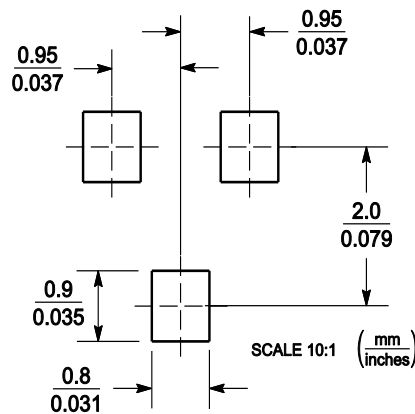

## DISCLAIMER

- Before you use our Products, you are requested to carefully read this document and fully understand its contents. LRC shall not be in any way responsible or liable for failure, malfunction or accident arising from the use of any LRC's Products against warning, caution or note contained in this document.
- All information contained in this document is current as of the issuing date and subject to change without any prior notice. Before purchasing or using LRC's Products, please confirm the latest information with a LRC sales representative.

单击下面可查看定价，库存，交付和生命周期等信息

[>>LRC\(乐山无线电\)](#)