

LGSOT05CLT1G

S-LGSOT05CLT1G

Dual Transient Voltage Suppressors
Array for ESD Protection

1. FEATURES

- We declare that the material of product compliance with RoHS requirements and Halogen Free.
- S- prefix for automotive and other applications requiring unique site and control change requirements; AEC-Q101 qualified and PPAP capable.
- 2 Unidirectional transil functions
- Low leakage current: $I_R \max < 20 \mu A$ at VRM
- 300W peak pulse power(8/20 μs)
- Transient protection for data lines as per IEC61000-4-2(ESD) 15KV(air) 8KV(contact) IEC61000-4-5(Lightning) see IPPM below

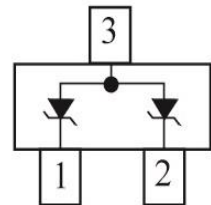
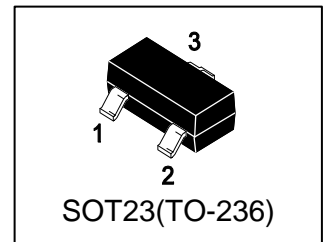

2. APPLICATIONS

- Computers
- Printers
- Communication systems

3. DEVICE MARKING AND ORDERING INFORMATION

Device	Marking	Shipping
LGSOT05CLT1G	05C	3000/Tape&Reel
LGSOT05CLT3G	05C	10000/Tape&Reel

4. ABSOLUTE RATINGS($T_a = 25^\circ C$)

Parameter	Symbol	Limits	Unit
Peak Pulse Power ($t_p = 8/20\mu s$)	PPP	300	W
Lead Solder Temperature - Maximum (10 Second Duration)	TL	260	$^\circ C$
Storage Temperature Range	Tstg	-55 ~ +150	$^\circ C$
Operating Temperature Range	Top	-40 ~ +125	$^\circ C$
Maximum junction temperature	Tj	150	$^\circ C$
Electrostatic discharge	VPP		kV
IEC61000-4-2 air discharge		15	
IEC61000-4-2 contact discharge		8	

5. ELECTRICAL CHARACTERISTICS (Ta= 25°C)

Symbol	Parameter
VRM	Stand-off voltage
VBR	Breakdown voltage
VCL	Clamping voltage
IRM	Leakage current
IPPM	Peak pulse current

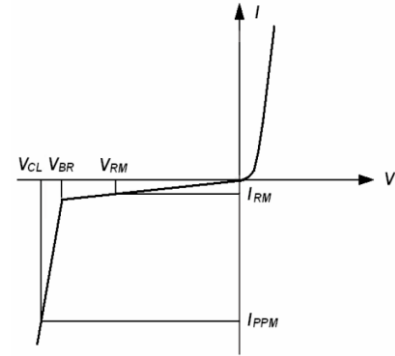

6. ELECTRICAL CHARACTERISTICS (Ta= 25°C)

DEVICE	VRWM (V)	IR (µA) @VRWM	VBR (V) @IT (Note 1)	IT (mA)	VC (V) @IPP=1A	VC (V) @IPP=5A	IPP(A) @tp=8/20µs	C (pF) f=1MHz
	Max.	Max.	Min.		Max.	Max.	Max.	Max.
LGSOT05CLT1G	5	5	6	1	9.8	12.5	17	220

1. 8/20 waveform used.

7. ELECTRICAL CHARACTERISTICS CURVES

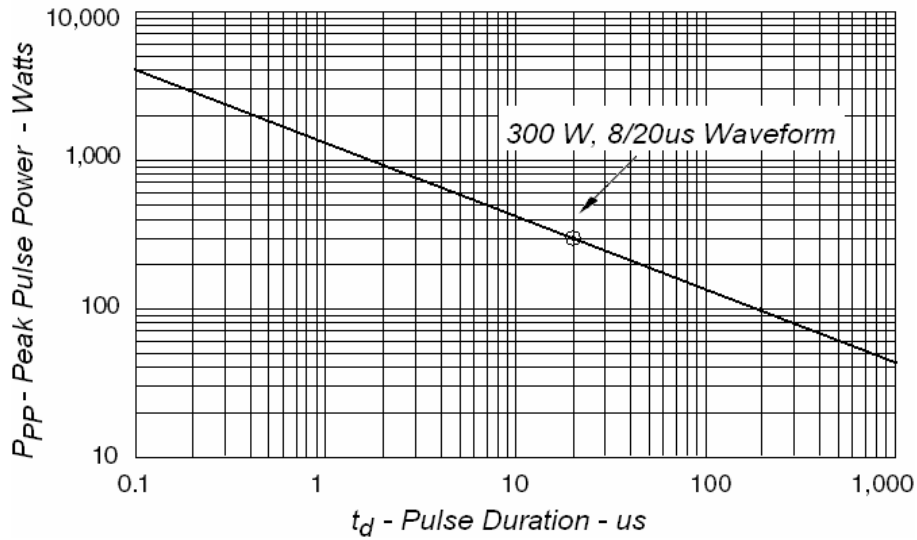

Fig1. Peak Pulse Power VS Pulse Time

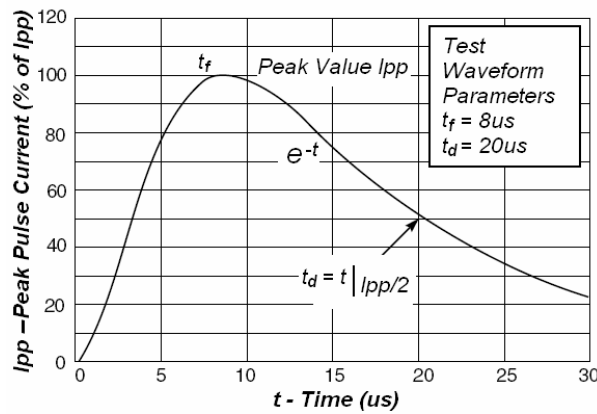

Fig2. Pulse Waveform

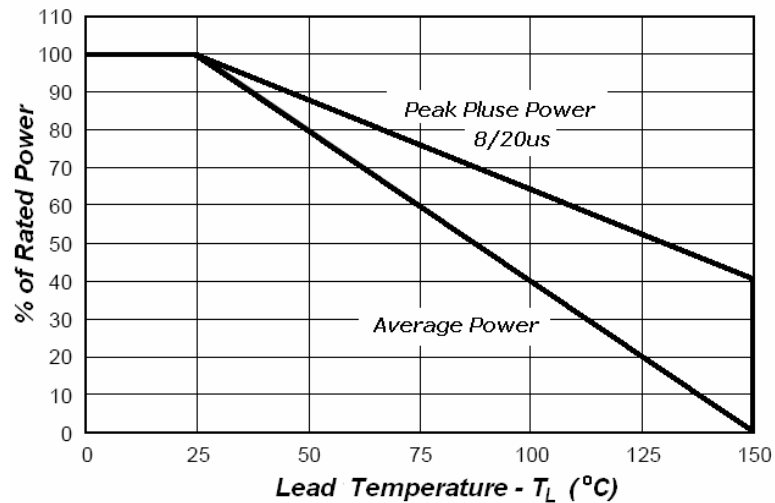
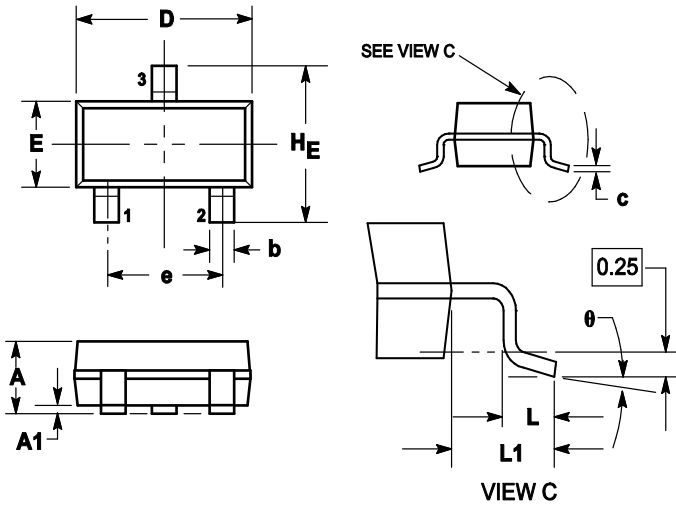

Fig3. Power Derating

8. OUTLINE AND DIMENSIONS

Notes:

1. DIMENSIONING AND TOLERANCING PER ANSI Y14.5M, 1982.
2. CONTROLLING DIMENSION: MILLIMETERS.
3. MAXIMUM LEAD THICKNESS INCLUDES LEAD FINISH. MINIMUM LEAD THICKNESS IS THE MINIMUM THICKNESS OF BASE MATERIAL.
4. DIMENSIONS D AND E DO NOT INCLUDE MOLD FLASH, PROTRUSIONS OR GATE BURRS.



DIM	MILLIMETERS			INCHES		
	MIN	NOM	MAX	MIN	NOM	MAX
A	0.89	1	1.11	0.035	0.04	0.044
A1	0.01	0.06	0.1	0.001	0.002	0.004
b	0.37	0.44	0.5	0.015	0.018	0.02
c	0.09	0.13	0.18	0.003	0.005	0.007
D	2.80	2.9	3.04	0.11	0.114	0.12
E	1.20	1.3	1.4	0.047	0.051	0.055
e	1.78	1.9	2.04	0.07	0.075	0.081
L	0.10	0.2	0.3	0.004	0.008	0.012
L1	0.35	0.54	0.69	0.014	0.021	0.029
HE	2.10	2.4	2.64	0.083	0.094	0.104
θ	0°	---	10°	0°	---	10°

9. SOLDERING FOOTPRINT

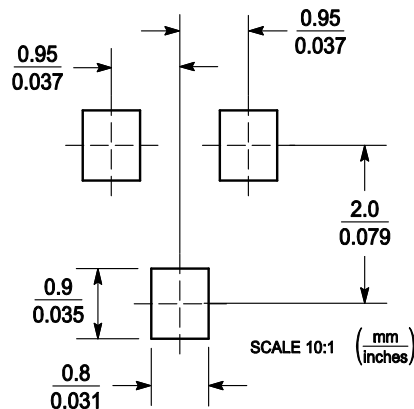

单击下面可查看定价，库存，交付和生命周期等信息

[>>LRC\(乐山无线电\)](#)

[>>点击查看相关商品](#)