

LBTP460Z4TZHG

S-LBTP460Z4TZHG

60 V PNP TRANSISTOR

1. FEATURES

- Low collector-emitter saturation voltage
- High collector current capability
- High collector current gain
- High efficiency due to less heat generation
- Smaller required Printed-Circuit Board (PCB)
- MM:>400V, HBM:>8000V
- We declare that the material of product compliance with RoHS requirements and Halogen Free.
- S- prefix for automotive and other applications requiring unique site and control change requirements; AEC-Q101 qualified and PPAP capable.

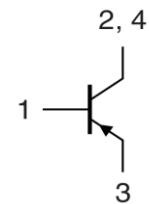
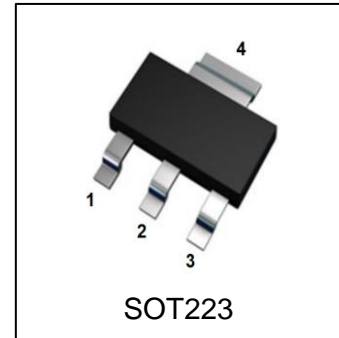

2. DEVICE MARKING AND ORDERING INFORMATION

Device	Marking	Shipping
LBTP460Z4TZHG	PD	1000/Tape&Reel

3. MAXIMUM RATINGS(Ta = 25°C)

Parameter	Symbol	Limits	Unit
Collector–Emitter Voltage	V _{CEO}	-60	V
Collector–Base Voltage	V _{CBO}	-60	V
Emitter–Base Voltage	V _{EBO}	-5	V
Collector Current — Continuous	I _C	-4.5	A
Peak Pulse Current(tp ≤ 1 ms)	I _{CM}	-9	A
Junction and Storage temperature	T _J , T _{stg}	-55~+150	°C

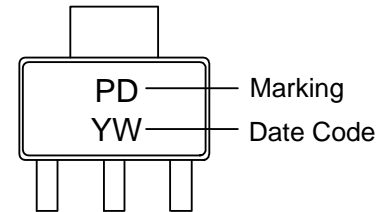

4. THERMAL CHARACTERISTICS

Parameter	Symbol	Limits	Unit
Total Device Dissipation, FR-4 Board (Note 1) @ TA = 25°C	PD	1	W
Thermal Resistance, Junction–to–Ambient(Note 1)	R _{θJA}	125	°C/W
Thermal Resistance, Junction–to–Case	R _{θJC}	30	°C/W

1. FR-4 = 30.0mm×25.0mm×1.6mm.

5. ELECTRICAL CHARACTERISTICS (Ta= 25°C)
OFF CHARACTERISTICS

Characteristic	Symbol	Min.	Typ.	Max.	Unit
Collector–Emitter Breakdown Voltage (IC = -1 mA, IB = 0)	VBR(CEO)	-60	-	-	V
Collector–Base Breakdown Voltage (IC = -100 μA, IE = 0)	VBR(CBO)	-60	-	-	V
Emitter–Base Breakdown Voltage (IE = -100 μA, IC = 0)	VBR(EBO)	-5	-	-	V
Collector Cutoff Current (VCB = -60V, IE = 0 A) (VCB = -60V, IE = 0 A, Tj = 150 °C)	ICBO	-	-	-100 -50	nA μA
Emitter CutOff Current (VEB = -5 V, IC = 0 A)	IEBO	-	-	-100	nA
Collector-Emitter cutoff Current (VCE= -60V, IB=0)	ICEO	-	-	-10	μA

ON CHARACTERISTICS (Note 2)

DC Current Gain (VCE = -2 V, IC = -0.5 A) (VCE = -2 V, IC = -1 A) (VCE = -2 V, IC = -2 A) (VCE = -2 V, IC = -4 A) (VCE = -2 V, IC = -6 A)	HFE	200 200 150 120 60	295 270 230 170 100	- - - - -	
Collector–Emitter Saturation Voltage (IC = -0.5 A, IB = -50 mA) (IC = -1 A, IB = -50 mA) (IC = -1 A, IB = -10 mA) (IC = -2 A, IB = -40 mA) (IC = -4 A, IB = -200 mA) (IC = -4 A, IB = -400 mA) (IC = -4.5 A, IB = -225 mA)	VCE(sat)	- - - - - - -	-35 -65 -130 -165 -210 -160 -265	-50 -90 -190 -230 -300 -230 -375	mV
Base–Emitter Saturation Voltage (IC = -1 A, IB = -100 mA) (IC = -4 A, IB = -400 mA)	VBE(sat)	- -	-0.81 -0.93	-0.9 -1.05	V
Base-Emitter Turn-On Voltage (VCE = -2 V, IC = -2 A)	VBE(on)	-	-0.77	-0.85	V

5. ELECTRICAL CHARACTERISTICS (Ta= 25°C)

SMALL-SIGNAL CHARACTERISTICS

Transitional Frequency (VCE = -10 V, IC = -100 mA, f = 100 MHz)	fT	-	102	-	MHz
Collector capacitance (VCB = -10 V, IE = ie = 0 A, f = 1 MHz)	Cc	-	66.5	120	pF

SWITCHING CHARACTERISTICS

Delay time	(VCC = -12.5 V, IC = -3 A, IB(on) = -0.15 A, IB(off) = 0.15 A)	td	-	15	-	ns
Rise time		tr	-	65	-	
Turn-on time		ton	-	80	-	
Storage time		ts	-	225	-	
Fall time		tf	-	95	-	
Turn-off time		toff	-	320	-	

2. Pulse Test: Pulse Width $\leq 300 \mu\text{s}$, Duty Cycle $\leq 2.0\%$.

6.ELECTRICAL CHARACTERISTICS CURVES

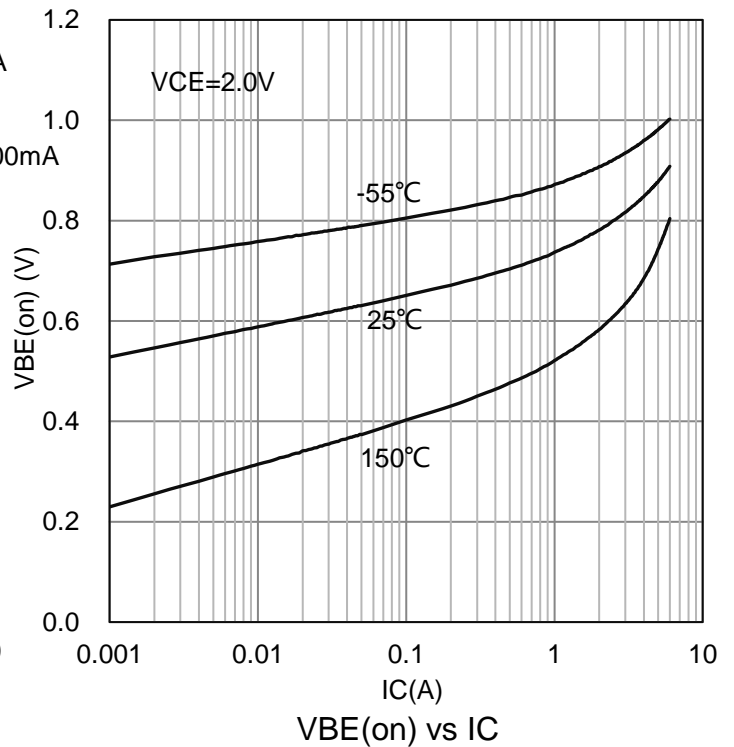
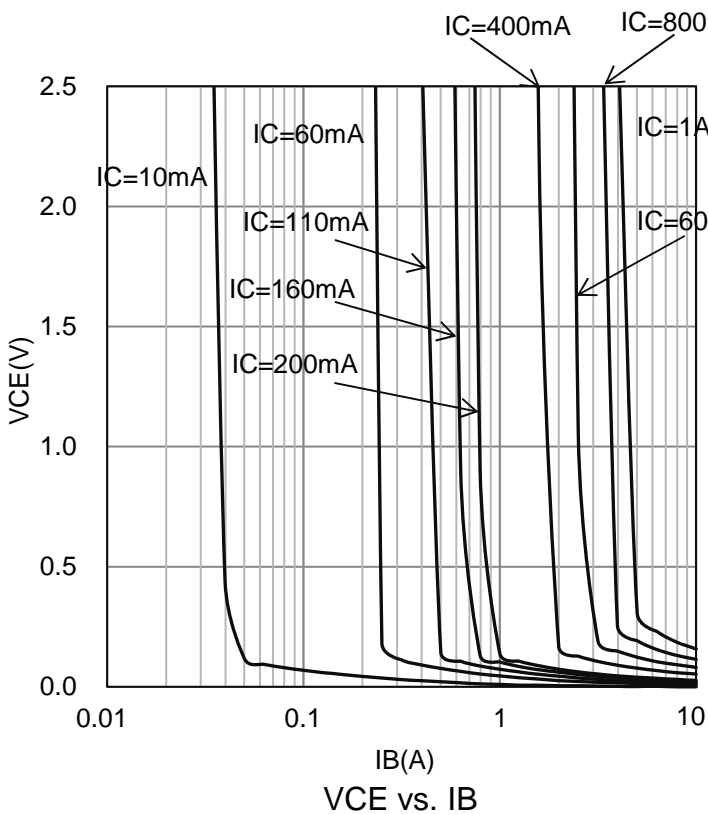
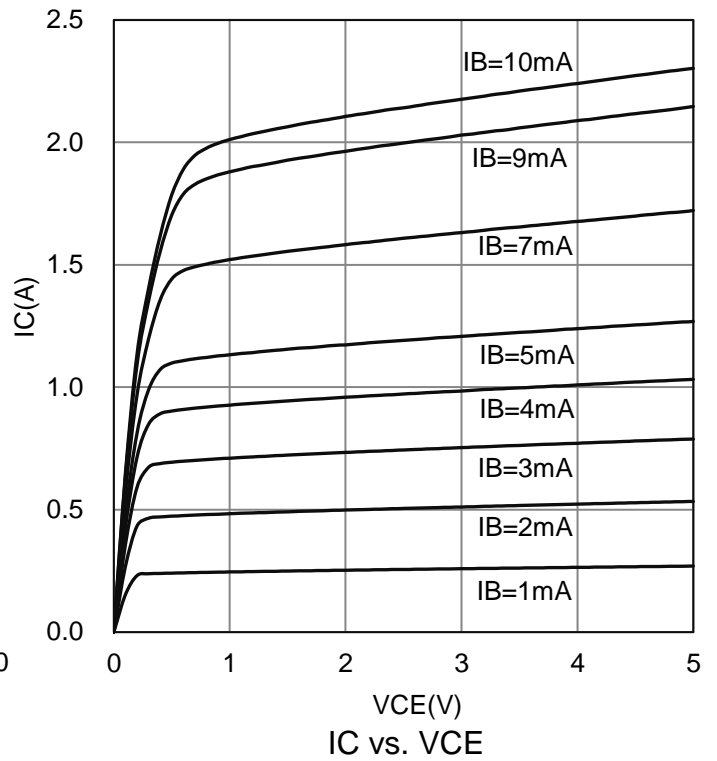
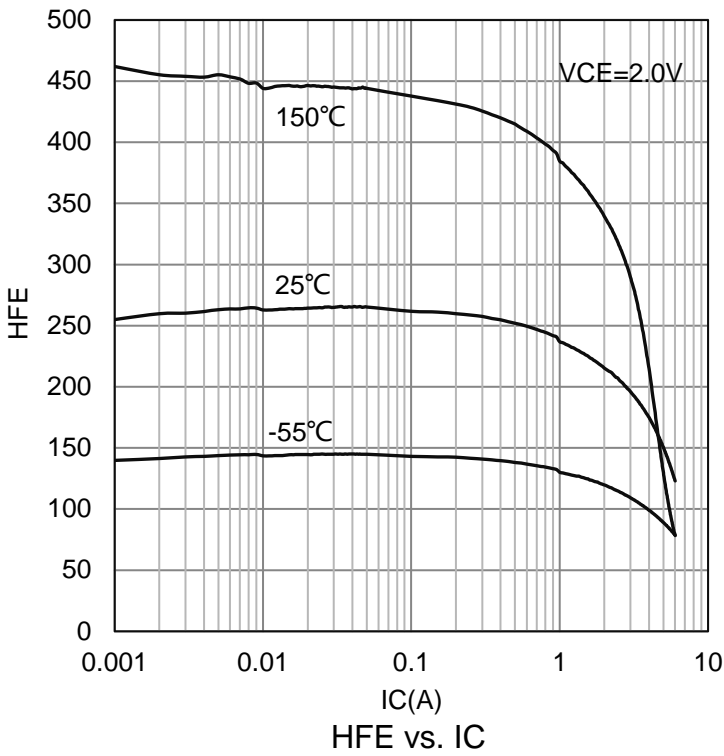

6.ELECTRICAL CHARACTERISTICS CURVES(Con.)

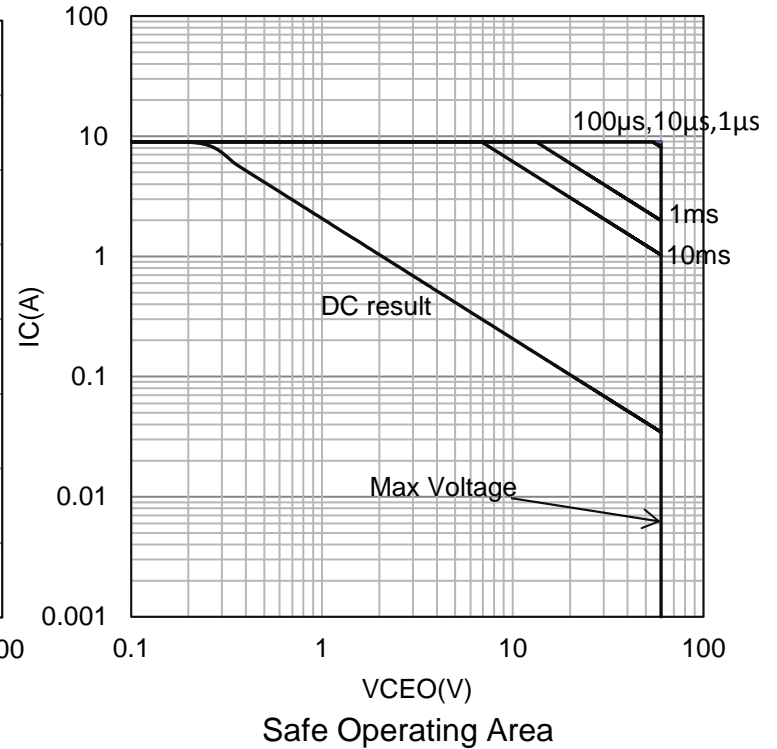
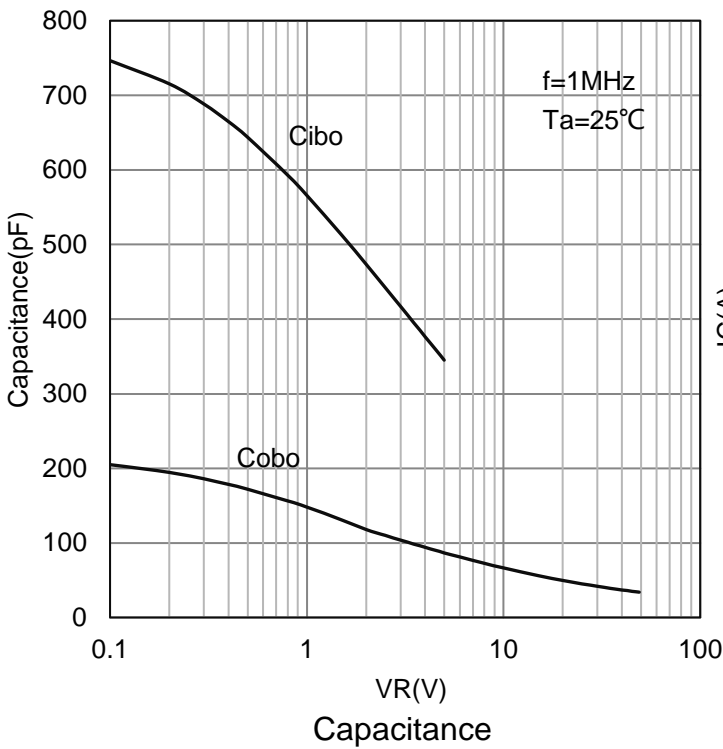
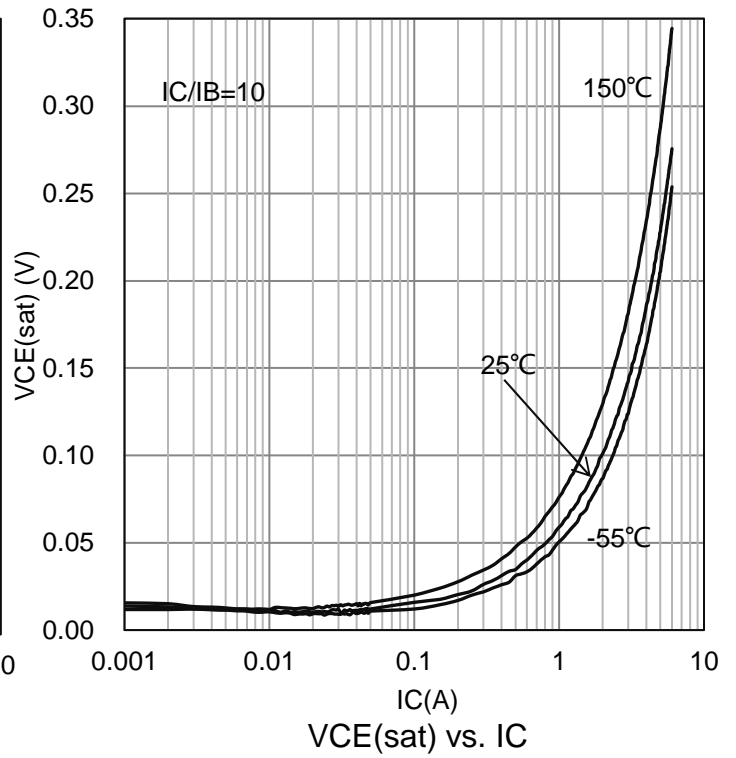
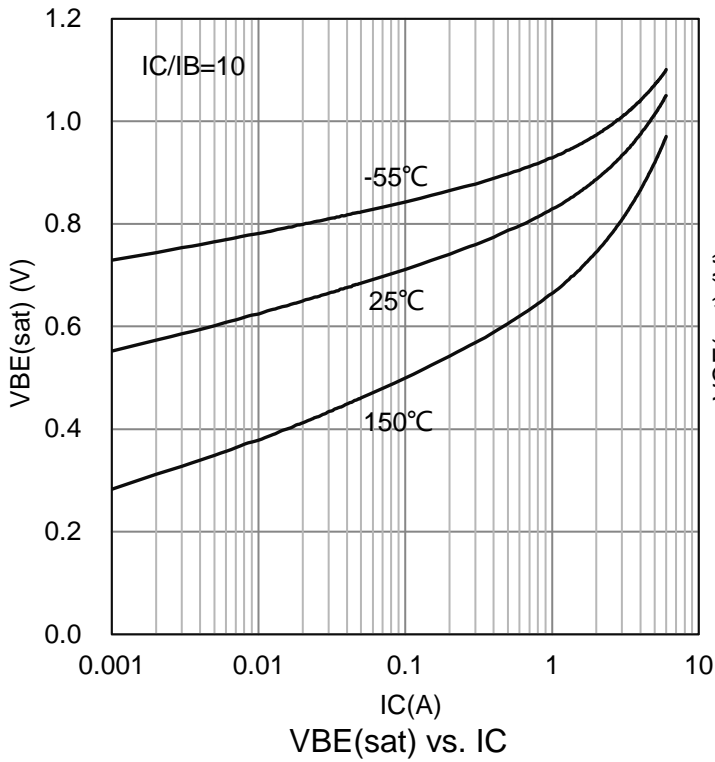

7. OUTLINE AND DIMENSIONS

SOT223

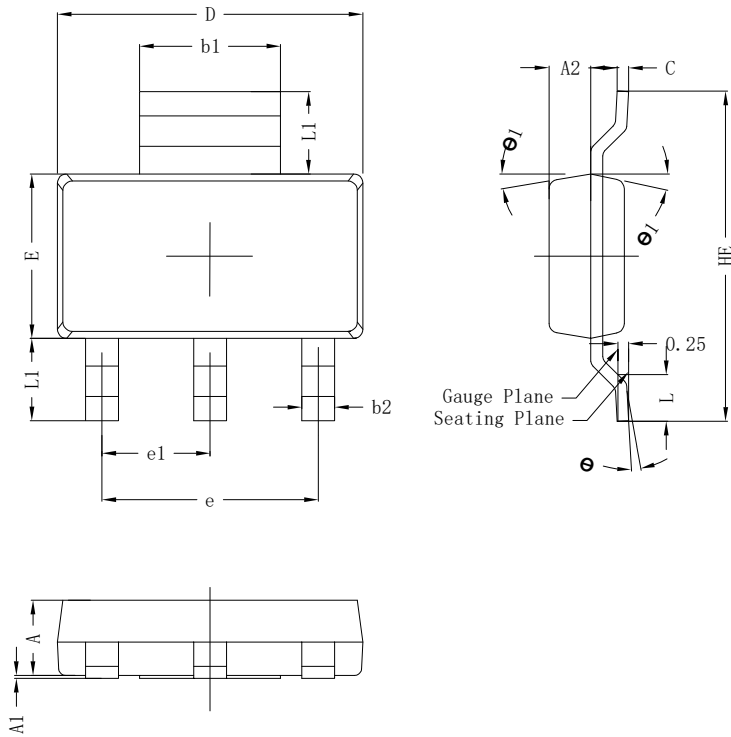

SOT223			
DIM	MIN	NOR	MAX
A	1.50	1.60	1.70
A1	0.00	0.05	0.10
A2	0.80	0.90	1.00
b1	2.90	3.02	3.10
b2	0.60	0.72	0.80
c	0.20	0.27	0.35
D	6.30	6.50	6.70
E	3.30	3.50	3.70
e	4.60BSC		
e1	2.30BSC		
HE	6.80	7.00	7.20
L	0.80	1.00	1.20
L1	1.75(REF)		
θ	0°~8°		
θ 1	8°	10°	12°
All Dimensions in mm			

GENERAL NOTES

1. Top package surface finish Ra0.4±0.2um
2. Bottom package surface finish Ra0.7±0.2um
3. Side package surface finish Ra0.4±0.2um
4. Protrusion or Gate Burrs shall not exceed 0.10mm per side.

8. SOLDERING FOOTPRINT

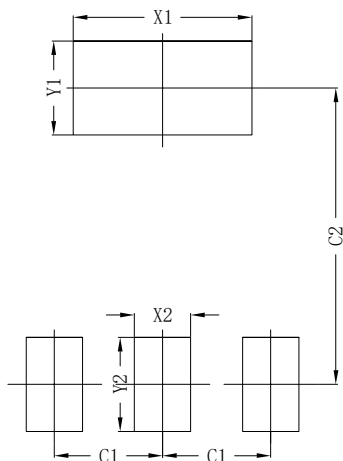

SOT223	
DIM	(mm)
X1	3.80
Y1	2.00
X2	1.20
Y2	2.00
C1	2.30
C2	6.30

DISCLAIMER

- Before you use our Products, you are requested to carefully read this document and fully understand its contents. LRC shall not be in any way responsible or liable for failure, malfunction or accident arising from the use of any LRC's Products against warning, caution or note contained in this document.
- All information contained in this document is current as of the issuing date and subject to change without any prior notice. Before purchasing or using LRC's Products, please confirm the latest information with a LRC sales representative.

单击下面可查看定价，库存，交付和生命周期等信息

[>>LRC\(乐山无线电\)](#)