

20V N-Channel Enhancement-Mode MOSFET

FEATURES

- $R_{DS(ON)} \leq 85m\Omega @ V_{GS}=4.5V$
- $R_{DS(ON)} \leq 115m\Omega @ V_{GS}=2.5V$
- $R_{DS(ON)} \leq 135m\Omega @ V_{GS}=1.8V$
- Super high density cell design for extremely low $R_{DS(ON)}$
- Exceptional on-resistance and maximum DC current capability
- S- Prefix for Automotive and Other Applications Requiring Unique Site and Control Change Requirements; AEC-Q101 Qualified and PPAP Capable.

APPLICATIONS

- Power Management in Notebook
- Portable Equipment
- Load Switch
- DSC

Ordering Information

Device	Marking	Shipping
LN2302BLT1G S-LN2302BLT1G	02B	3000/Tape&Reel
LN2302BLT3G S-LN2302BLT3G	02B	10000/Tape&Reel

LN2302BLT1G
S-LN2302BLT1G

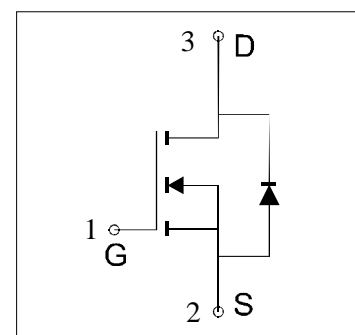
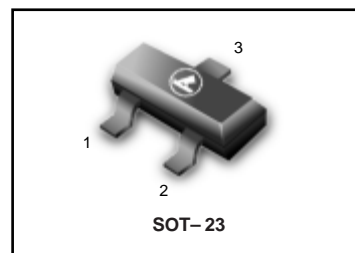

Absolute Maximum Ratings (T_A=25°C Unless Otherwise Noted)

Parameter	Symbol	Limit	Unit
Drain-Source Voltage	V _{DSS}	20	V
Gate-Source Voltage	V _{GSS}	±8	V
Continuous Drain Current (t _J =150°C)	I _D	T _A =25°C	A
		T _A =70°C	
Pulsed Drain Current	I _{DM}	10	
Maximum Body-Diode Continuous Current	I _S	1.6	A
Maximum Power Dissipation	P _D	T _A =25°C	W
		T _A =70°C	
Operating Junction Temperature	T _J	150	°C
Maximum Junction-to-Ambient	R _{thJA}	T ≤ 10 sec	77
		Steady State	105
Thermal Resistance-Junction to Case	R _{θJC}	70	°C/W

*The device mounted on 1in² FR4 board with 2 oz copper

LN2302BLT1G , S-LN2302BLT1G

ELECTRICAL CHARACTERISTICS

Symbol	Parameter	Limit	Min	Typ	Max	Unit
STATIC PARAMETERS						
$V_{(BR)DSS}$	Drain-Source Breakdown Voltage	$V_{GS}=0V, I_D=250 \mu A$	20			V
$V_{GS(th)}$	Gate Threshold Voltage	$V_{DS}=V_{GS}, I_D=250 \mu A$	0.6	0.9	1.2	
I_{GSS}	Gate-Body Leakage Current	$V_{DS}=0V, V_{GS}=\pm 8V$			± 100	nA
I_{DSS}	Zero Gate Voltage Drain Current	$V_{DS}=20V, V_{GS}=0V$			1	μA
		$V_{DS}=20V, V_{GS}=0V$ $T_J=55^\circ C$			10	
$I_{D(ON)}$	On-State Drain Current ^a	$V_{DS} \geq 5V, V_{GS}=4.5V$	6			A
		$V_{DS} \geq 5V, V_{GS}=2.5V$	4			
$R_{DS(ON)}$	Drain-Source On-Resistance	$V_{GS}=4.5V, I_D=2.8A$		55	85	m Ω
		$V_{GS}=2.5V, I_D=2.5A$		65	115	
		$V_{GS}=1.8V, I_D=2.2A$		80	130	
V_{SD}	Diode Forward Voltage	$I_S=1A, V_{GS}=0V$		0.75	1.2	V
DYNAMIC PARAMETERS						
Q_g	Total Gate Charge	$V_{DS}=10V, V_{GS}=4.5V, I_D=2.8A$		9		nC
Q_{gs}	Gate-Source Charge			2.2		
Q_{gd}	Gate-Drain Charge			3		
C_{iss}	Input Capacitance	$V_{DS}=10V, V_{GS}=0V, f=1MHz$		450		pF
C_{oss}	Output Capacitance			72		
C_{rss}	Reverse Transfer Capacitance			22		
$t_{d(on)}$	Turn-On Delay Time	$V_{DD}=10V, R_L=10\Omega$ $V_{GEN}=4.5\Omega, R_G=6\Omega$		9		ns
t_r	Rise Time			23		
$t_{d(off)}$	Turn-Off Delay Time			38		
t_f	Fall Time			3		

Notes:

 a. Pulse test; pulse width $\leq 300\mu s$, duty cycle $\leq 2\%$

Typical Characteristics (T_J =25°C Noted)

LN2302BLT1G , S-LN2302BLT1G

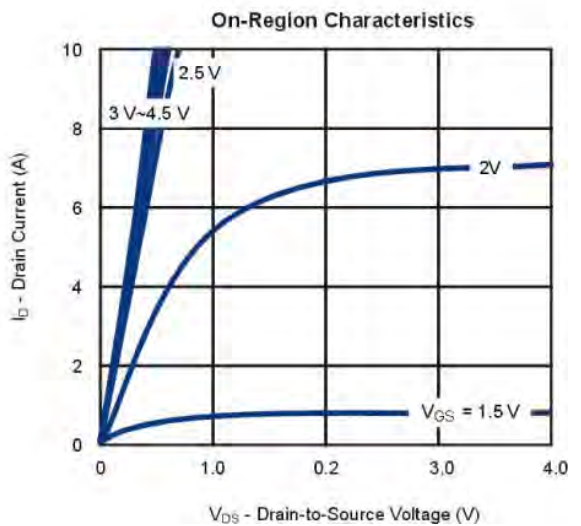
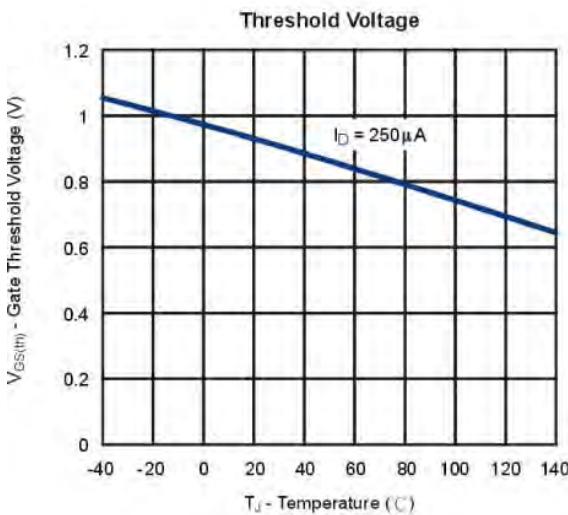
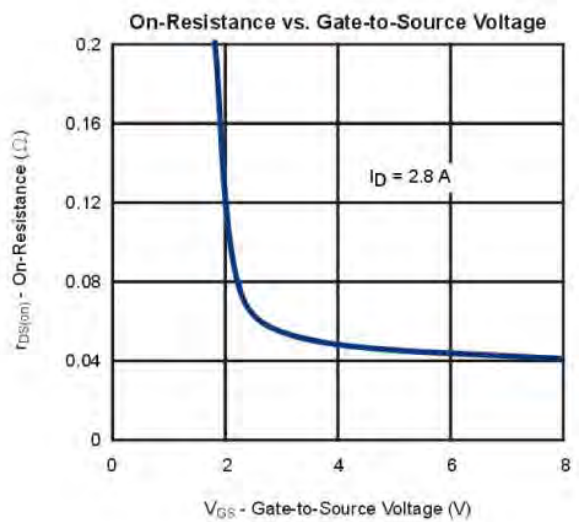
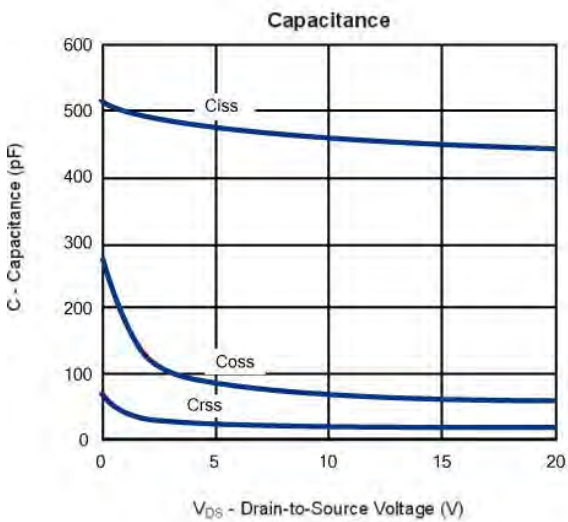
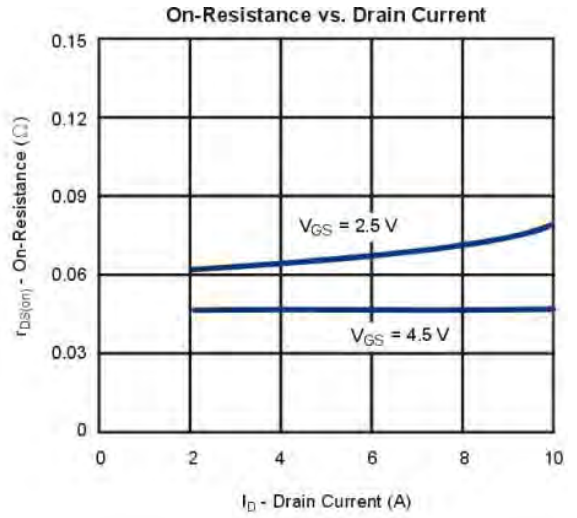
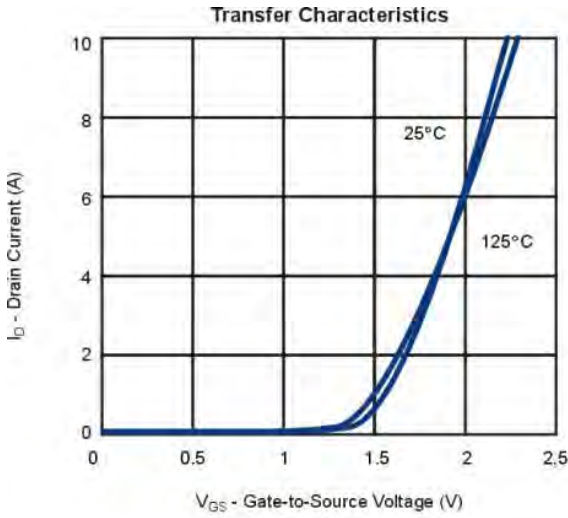

LN2302BLT1G , S-LN2302BLT1G

Typical Characteristics (T_J = 25°C Noted)

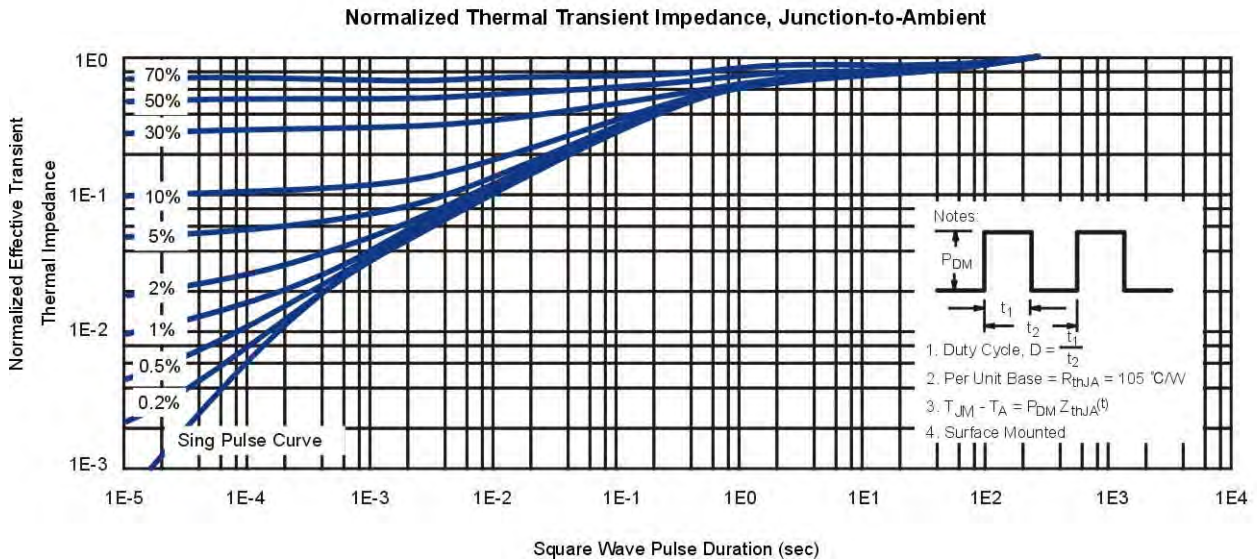
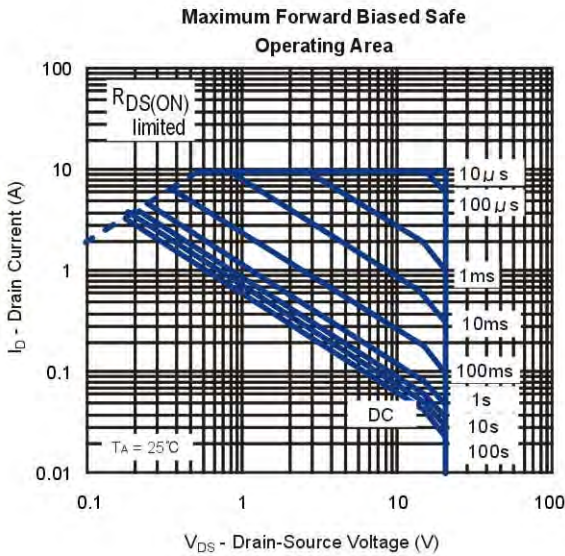
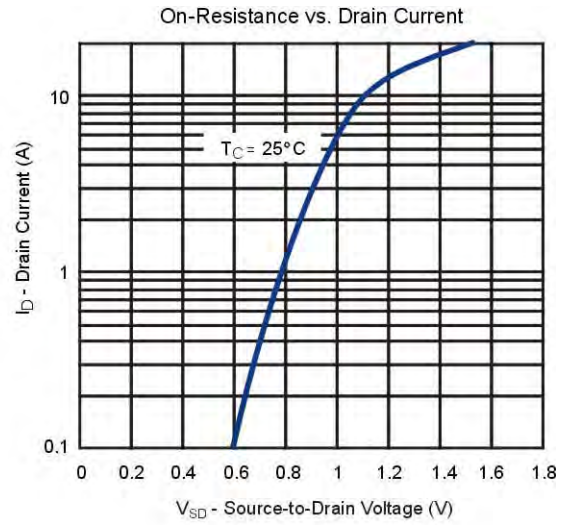
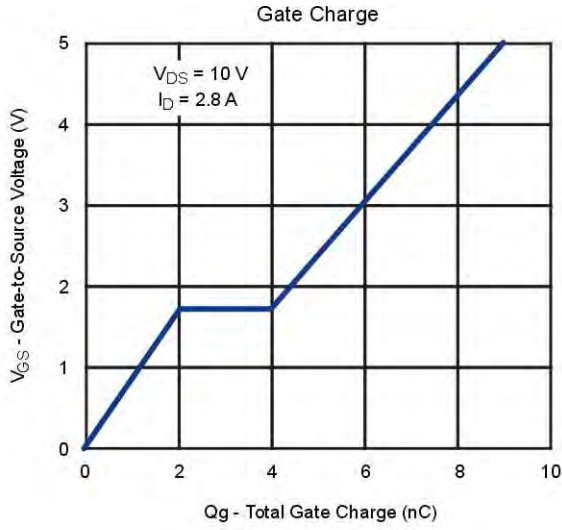

LN2302BLT1G , S-LN2302BLT1G

SOT-23

NOTES:

1. DIMENSIONING AND TOLERANCING PER ANSI Y14.5M,1982
2. CONTROLLING DIMENSION: INCH.

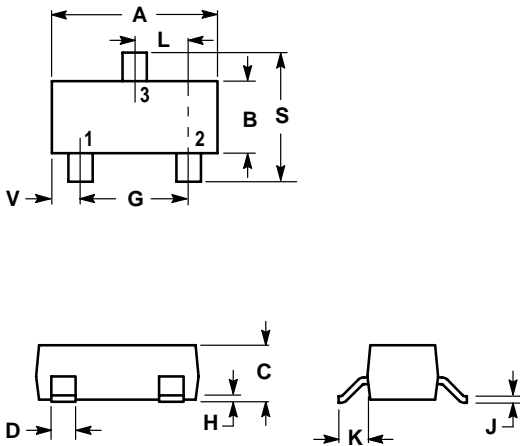

DIM	INCHES		MILLIMETERS	
	MIN	MAX	MIN	MAX
A	0.1102	0.1197	2.80	3.04
B	0.0472	0.0551	1.20	1.40
C	0.0350	0.0440	0.89	1.11
D	0.0150	0.0200	0.37	0.50
G	0.0701	0.0807	1.78	2.04
H	0.0005	0.0040	0.013	0.100
J	0.0034	0.0070	0.085	0.177
K	0.0140	0.0285	0.35	0.69
L	0.0350	0.0401	0.89	1.02
S	0.0830	0.1039	2.10	2.64
V	0.0177	0.0236	0.45	0.60

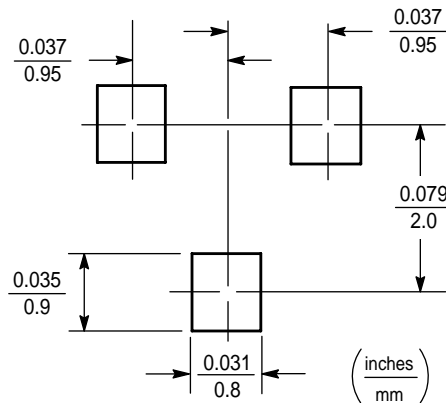

单击下面可查看定价，库存，交付和生命周期等信息

[>>LRC\(乐山无线电\)](#)

[>>点击查看相关商品](#)