

# LD50SB10 Thru LD50SB120

## High Current Glass Passivated Molding Single-Phase Bridge Rectifier

### Reverse Voltage 100 to 1200V Forward Current 50 A

### FEATURES

- Plastic Package has Underwriters Laboratory Flammability Classification 94V-0
- High current capacity with small package
- Glass passivated chip junctions
- Low thermal resistance
- High IFSM

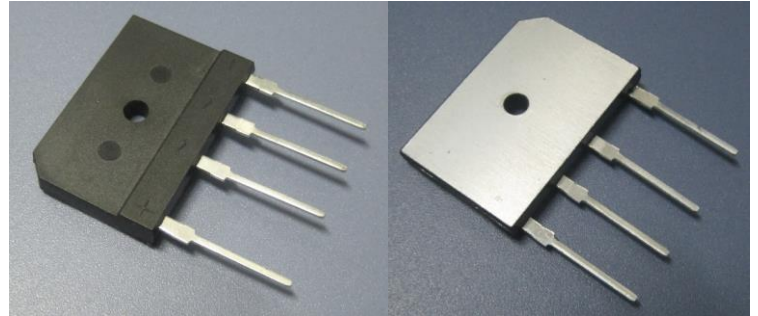

### 1. Maximum & Thermal Characteristics Ratings at 25°C ambient temperature unless otherwise specified.

Parameter Symbol	Symbol	LD50 SB10	LD50 SB20	LD50 SB40	LD50 SB60	LD50 SB80	LD50S B100	LD50SB 120	Unit
Maximum repetitive voltage	VRRM	100	200	400	600	800	1000	1200	V
Maximum RMS Voltage	VRMS	70	140	280	420	560	700	840	V
Maximum DC Blocking Voltage	VDC	100	200	400	600	800	1000	1200	V
Maximum DC reverse current TA=25 °C	IR	10							μA
at rated DC blocking voltage TA=125°C		500							
Maximum average forward rectified output current at	Io	50							A
		10							A
Peak forward surge current 8.3ms single half sine-wave superimposed on rated load	IFSM	450							A
Rating of fusing (t<8.3ms)	i <sup>2</sup> t	840							A2sec
Dielectric strength terminals to case, AC 1 minute Current 1mA	Vdia	2.5							KV
Max instantaneous forward voltage at 25A	VF	1.05							V
Operating junction temperature	TJ	-55~150							°C
Maximum thermal on P.C.B. without heat-sink	RθJA	15							°C/W
resistance per leg on Al plate heat-sink <sup>(3)</sup>	RθJC	0.75							
Storage temperature	Tstg	-55~150							°C
Mounting torque	Tor	Rating Torque : 0.8 (Suggests 0.45~0.65)							N.m

Notes:

- (1) Unit case mounted on aluminum plate heatsink
- (2) Units mounted on P.C.B. without heatsink

(3) Device mounted on the heat sink

# LD50SB10 Thru LD50SB120

## 2. Ratings and Characteristic Curves (TA = 25°C unless otherwise noted)

Fig. 1 Derating Curve

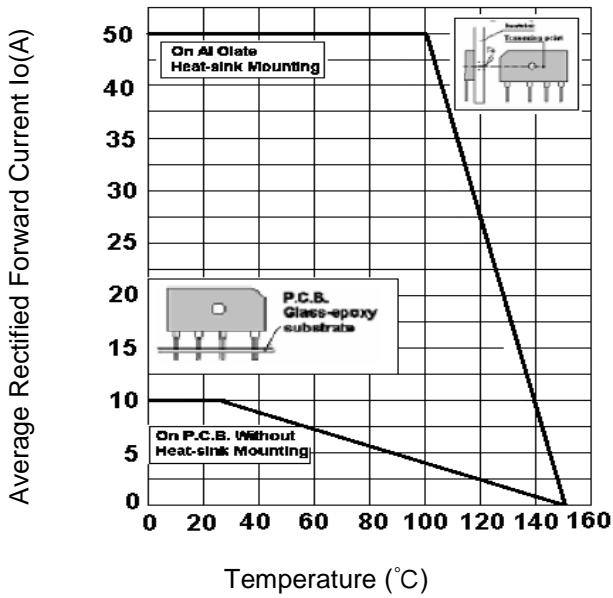

Fig.2 Typical Reverse Characteristics

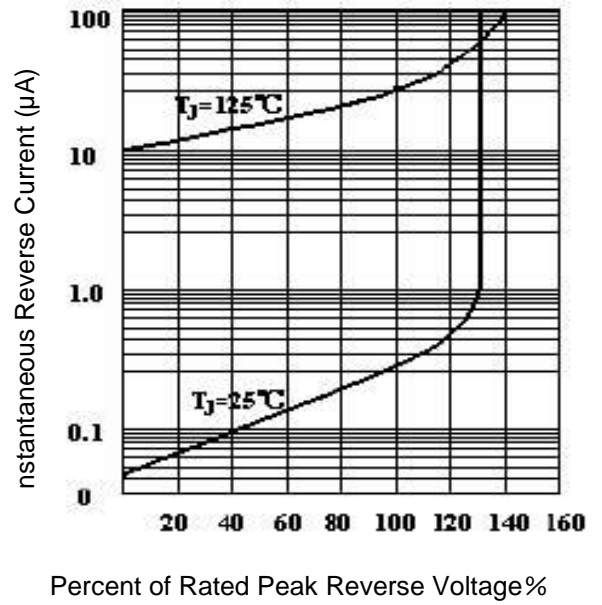

Fig.3 Forward Voltage

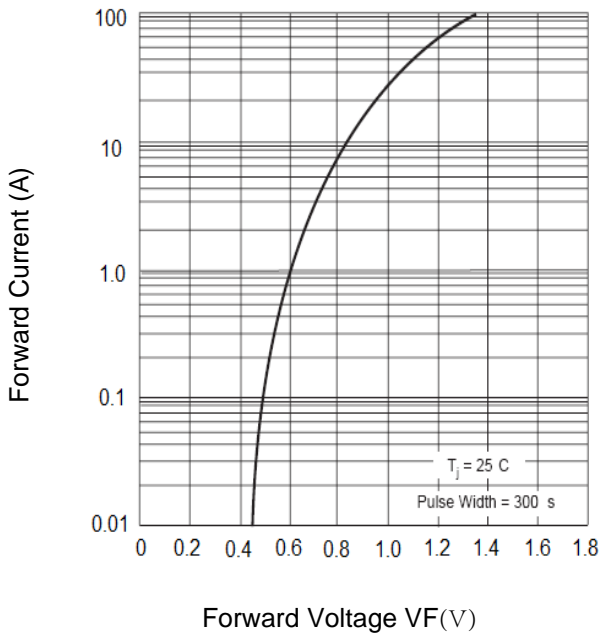
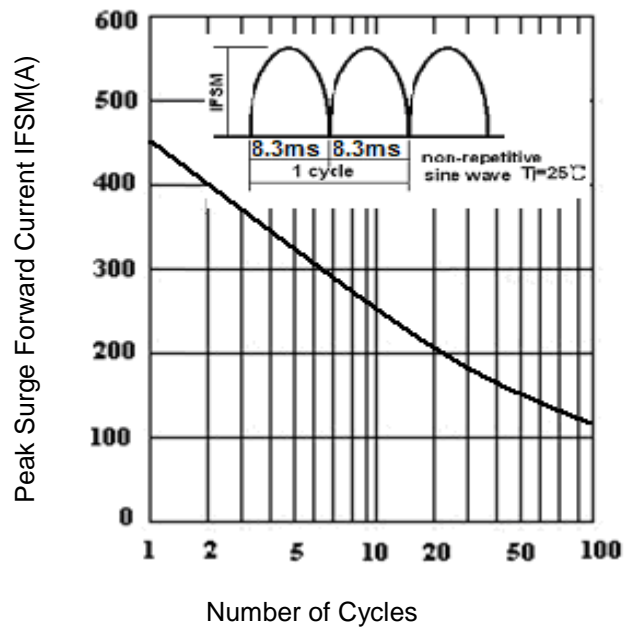
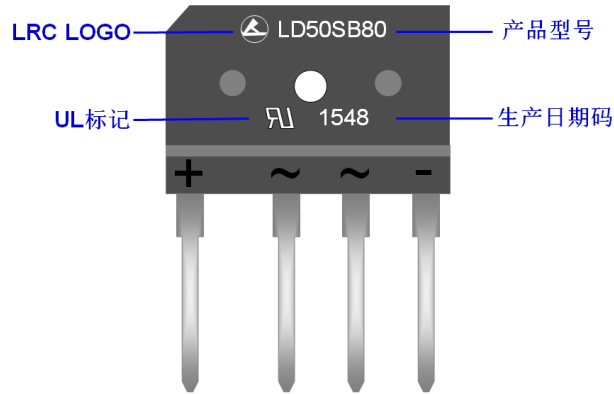

Fig.4 Peak Surge Forward Capability



# LD50SB10 Thru LD50SB120

## 3. Marking Identification



### Note:

生产日期码包含4位数字，例如“1548”，前两个数字“15”表示为2015年，另外二个数字“48”是指第48周，即表示该产品为2015年48周生产。

型号：

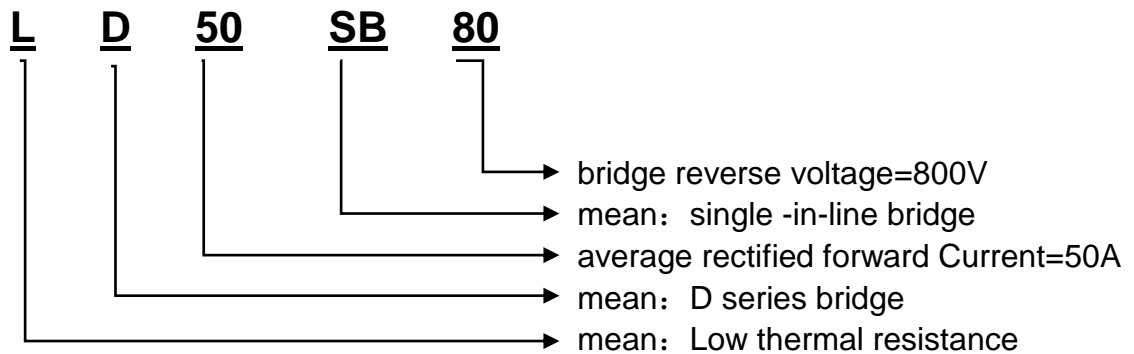

## 4. Dimension

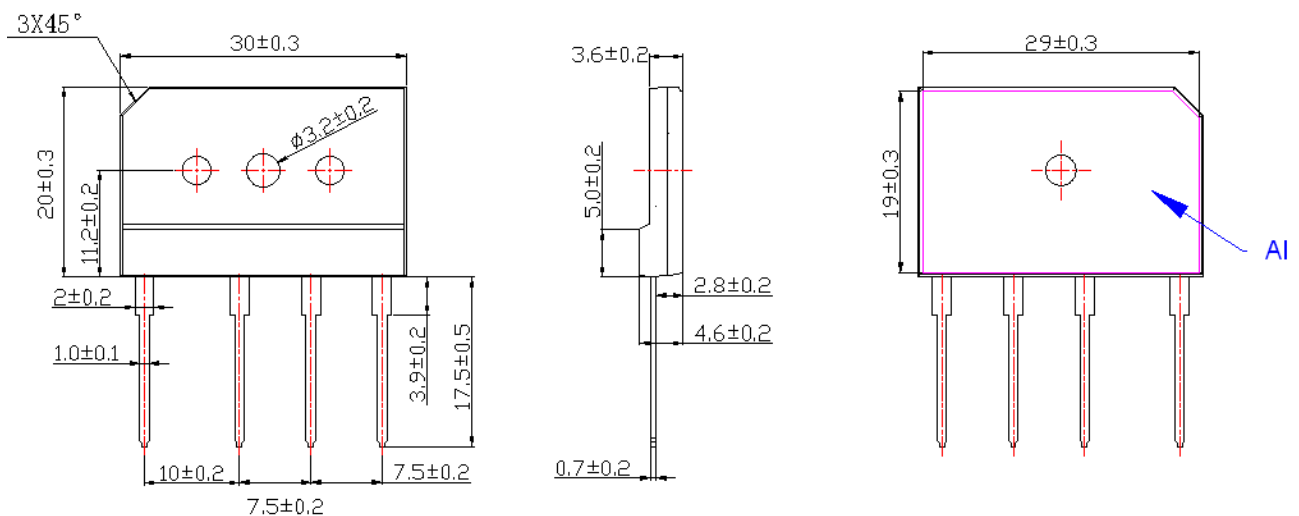

# LD50SB10 Thru LD50SB120

## 5. Update Record

版次	更新记录	更新作者	更新日期
1	第一版	王锋	2018-8-25
2	调整铝板尺寸	伍泽雄	2018-11-06

单击下面可查看定价，库存，交付和生命周期等信息

[>>LRC\(乐山无线电\)](#)