

LP50N04D2

40V P-Channel (D-S) MOSFET

1. FEATURES

- Low RDS(on) trench technology
- Low thermal impedance.
- Fast switching speed.
- We declare that the material of product compliance with RoHS requirements and Halogen Free.

2. APPLICATIONS

- Load Switches
- DC-DC conversion
- Motor Drives

3. DEVICE MARKING AND RESISTOR VALUES

Device	Marking	Shipping
LP50N04D2	50N04	2500pcs/Tape&Reel

4. MAXIMUM RATINGS(Ta = 25°C)

Parameter		Symbol	Limits	Unit
Drain-to-Source Voltage		VDS	-40	V
Gate-to-Source Voltage		VGS	± 20	V
Continuous Drain Current(Note 1)	TA=25°C	ID	-50	A
	TC=25°C		-32	
Pulsed Drain Current (Note 2)		IDM	-200	A
Avalanche Current		IAS	34	A
Avalanche Energy(L=0.1mH)		EAS	57.8	mJ
Power Dissipation(Note 1)	TC=25°C	PD	62.5	W
	TC=100°C		25	
Operating Junction and Storage Temperature Range		Tj/Tstg	-55~+150	°C

5. THERMAL CHARACTERISTICS

Parameter	Symbol	Max	Unit
Junction-to-Ambient(Note 1)	RθJA	50	°C/W
Junction-to-Case	RθJC	2	

1.Surface mounted on "1.5 x 1.5" FR4 board using 1 sq in pad, 2 oz Cu.

2.Pulse width limited by maximum junction temperature

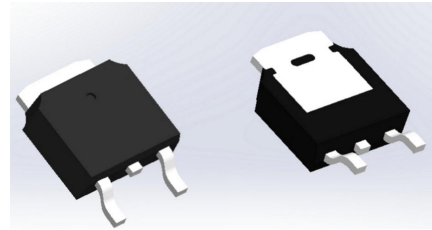

TO-252-2L

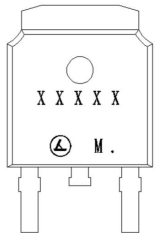

Top View

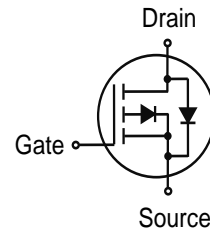

6. ELECTRICAL CHARACTERISTICS (Ta= 25°C)

Characteristic	Symbol	Min.	Typ.	Max.	Unit	
Static						
Drain-Source Breakdown Voltage (VGS = 0 V, ID = -250 μA)	VBRDSS	-40	-	-	V	
Gate Threshold Voltage (VDS = VGS, ID = -250 μA)	VGS(th)	-1	-	-3	V	
Gate-Body leakage current (VDS = 0 V, VGS = ±20 V)	IGSS	-	-	±100	nA	
Zero Gate Voltage Drain Current (VDS = -32 V, VGS = 0 V)	IDSS	-	-	-1	μA	
Drain-to-Source On-Resistance (Note 3) (VGS = -10 V, ID = -5 A) (VGS = -4.5 V, ID = -3 A)	RDS(ON)	-	-	12 18	mΩ	
Diode Forward Voltage (IS = -1 A, VGS = 0 V)	VSD	-	-	-1.2	V	
Dynamic						
Total Gate Charge	(VDS = -20 V, VGS = -10 V, ID = -5 A)	Qg	-	72.5	-	nC
Gate to Source Charge		Qgs	-	7.5	-	
Gate to Drain Charge		Qgd	-	13.5	-	
Turn-on Delay Time	(VDS = -20 V, ID = -5 A, VGS = -10 V, RG = 6 Ω)	td(on)	-	15.5	-	nS
Rise Time		tr	-	17	-	
Turn-Off Delay Time		td(off)	-	155	-	
Fall Time		tf	-	62	-	
Input Capacitance	(VDS = -20 V, VGS = 0 V, f = 1 MHz)	Ciss	-	4200	-	pF
Output Capacitance		Coss	-	305	-	
Reverse Transfer Capacitance		Crss	-	285	-	

3. Pulse test: PW ≤ 300μs duty cycle ≤ 2%.

7. ELECTRICAL CHARACTERISTICS CURVES

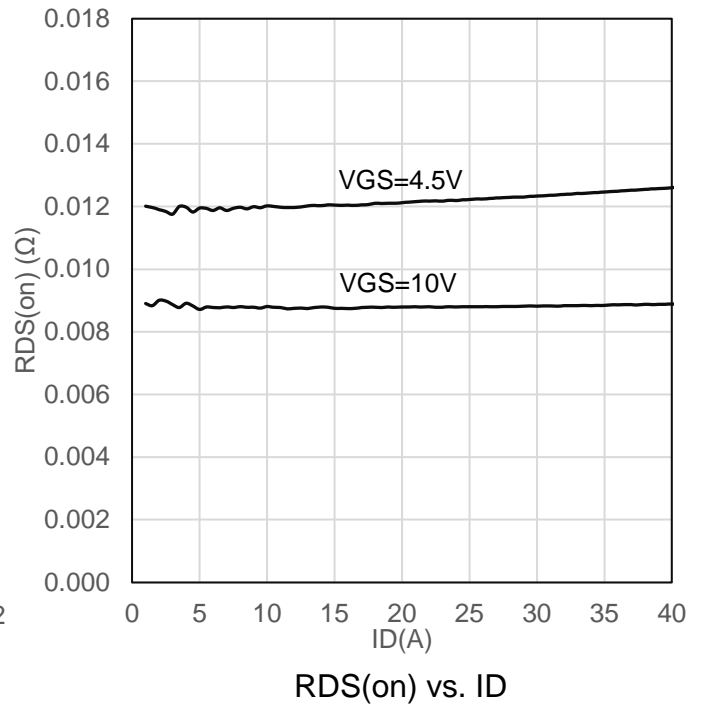
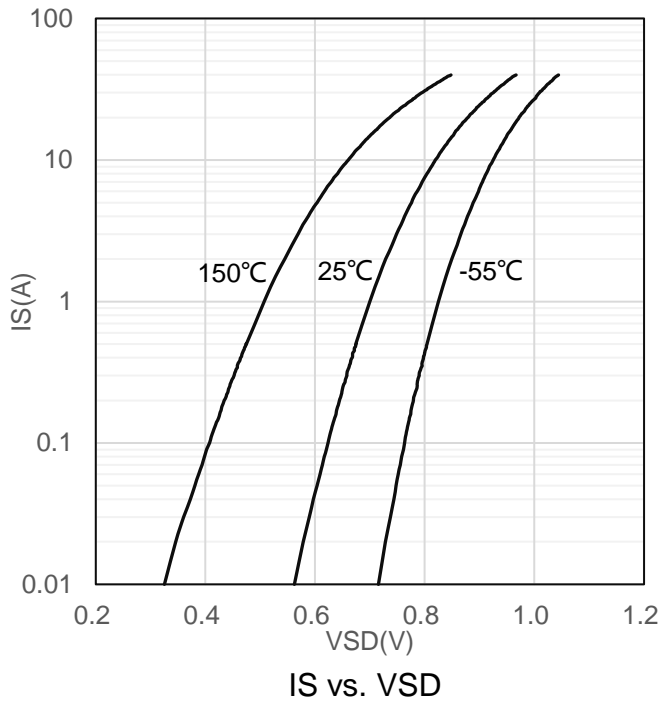
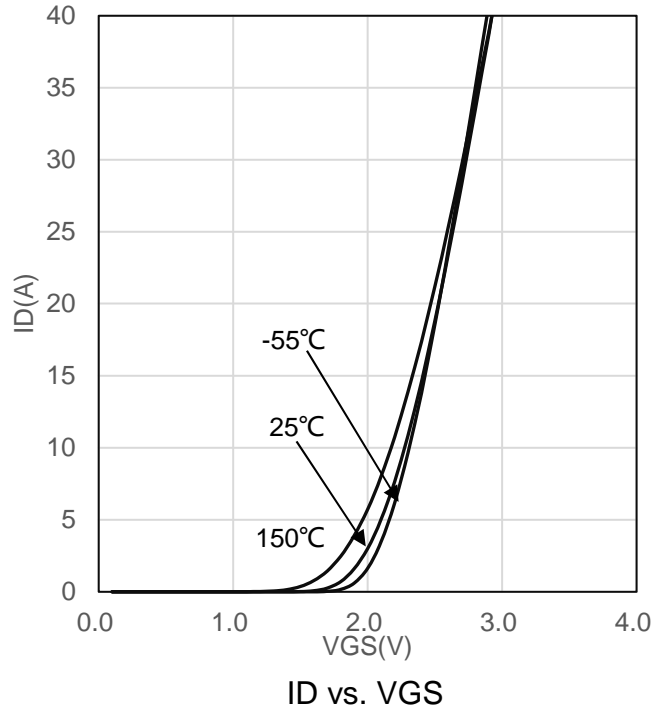
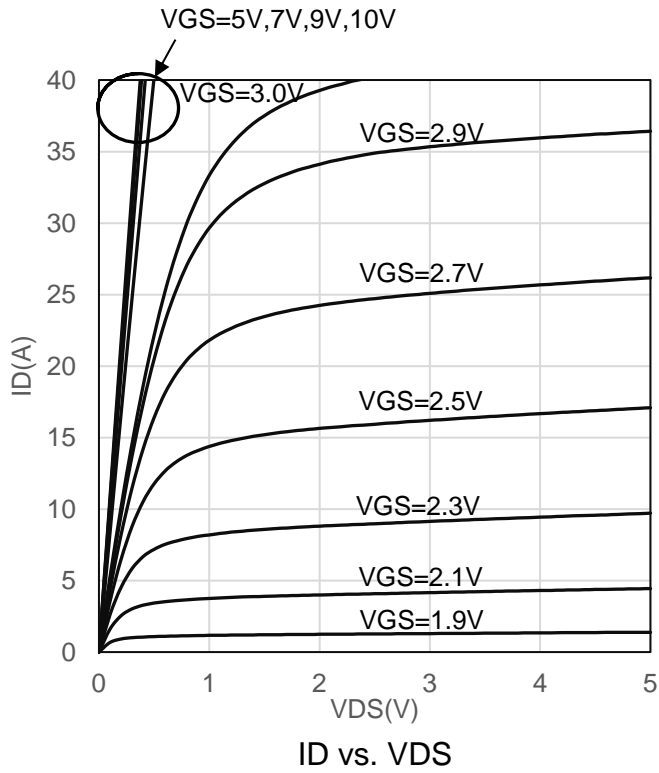

7. ELECTRICAL CHARACTERISTICS CURVES(Con.)

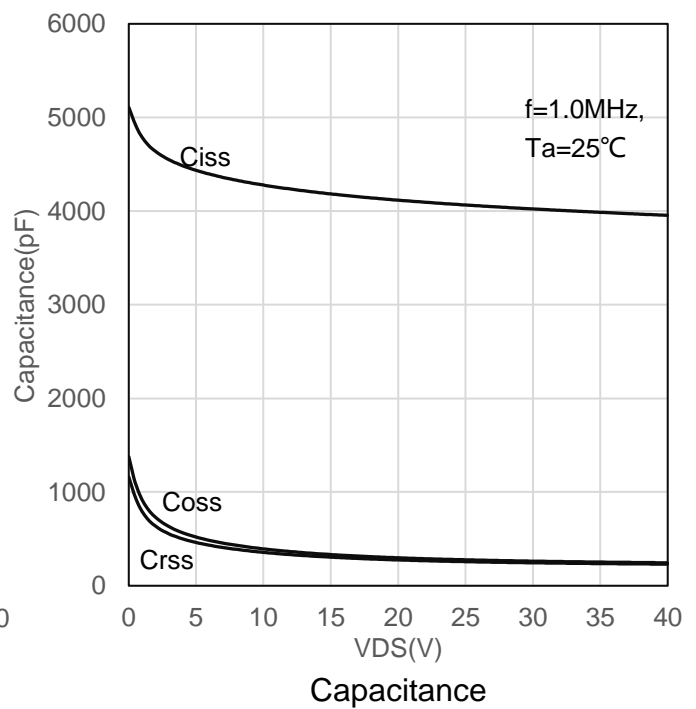
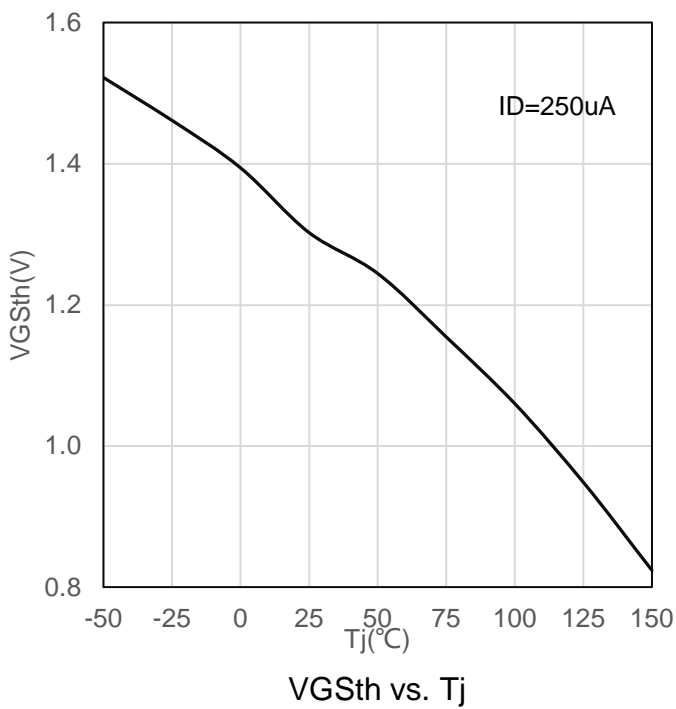
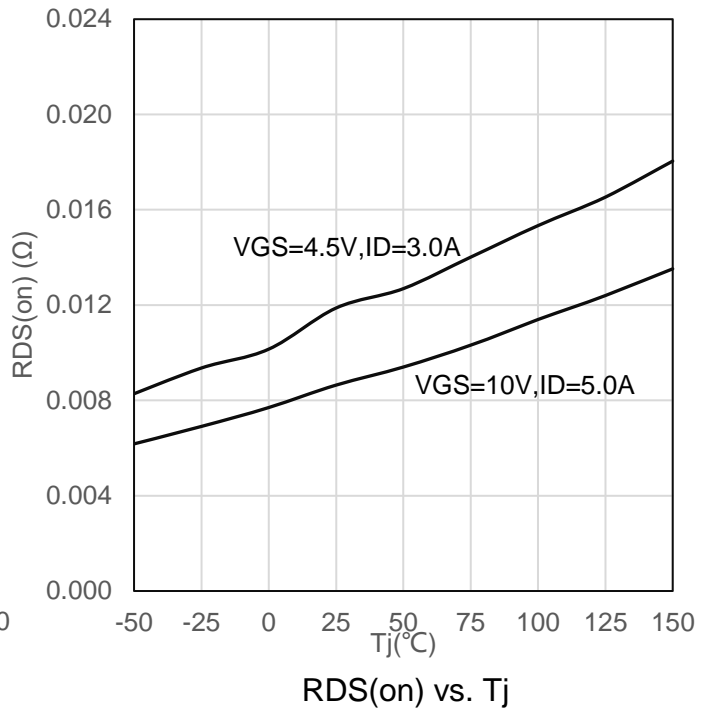
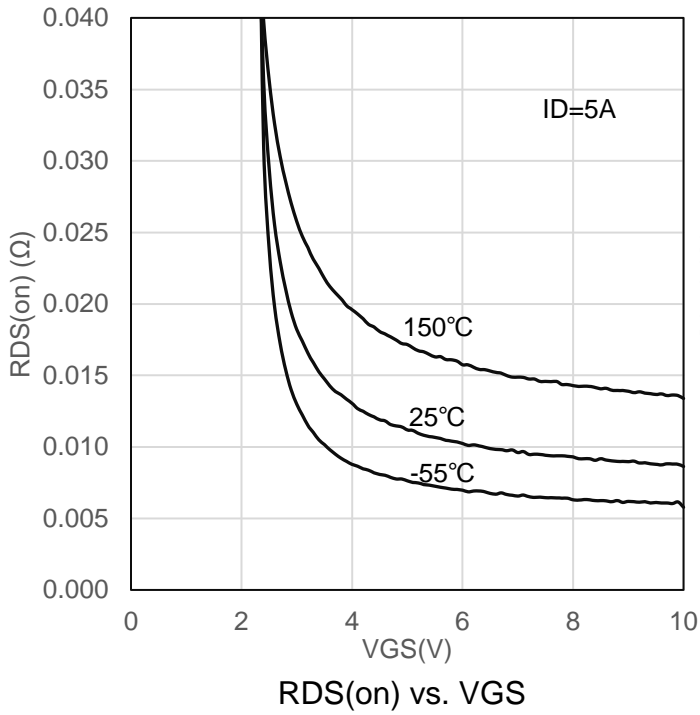

7. ELECTRICAL CHARACTERISTICS CURVES(Con.)

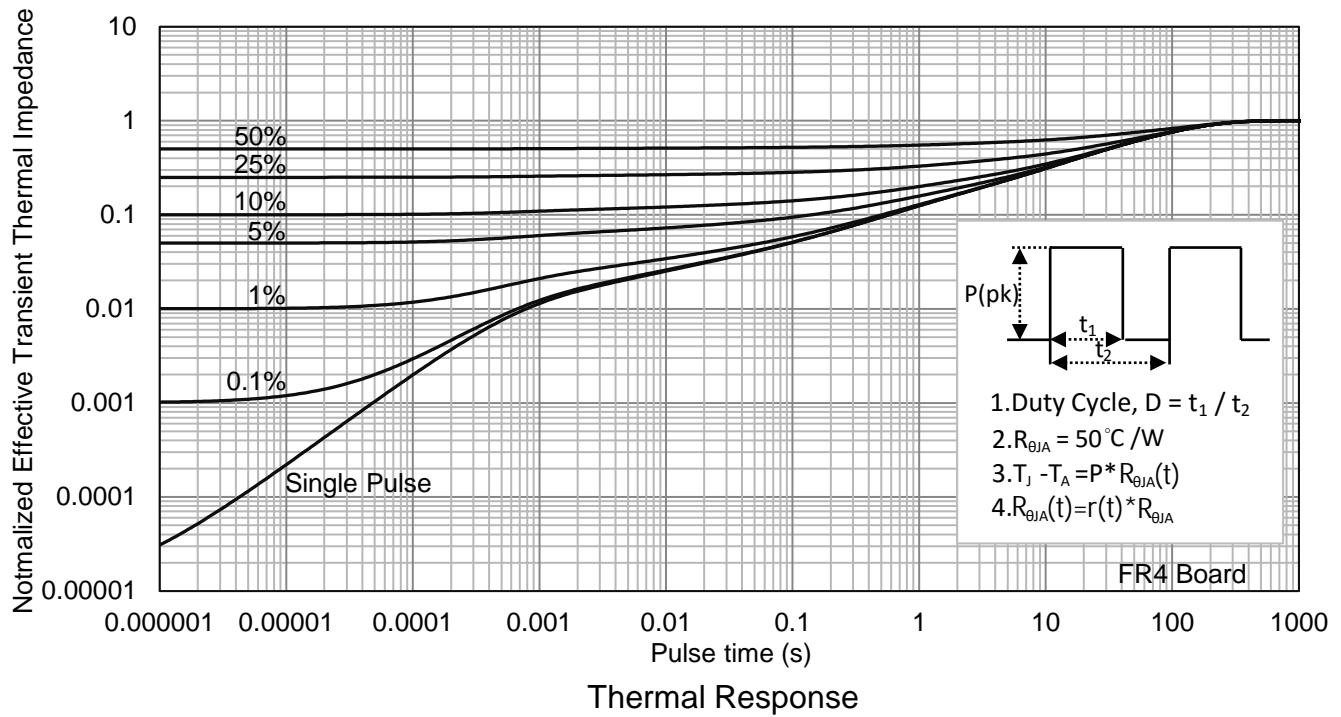
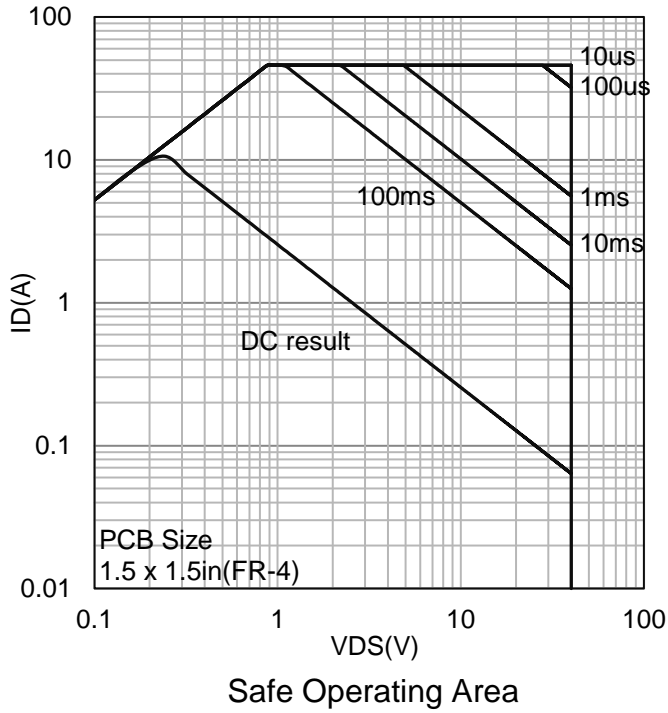

8. OUTLINE AND DIMENSIONS

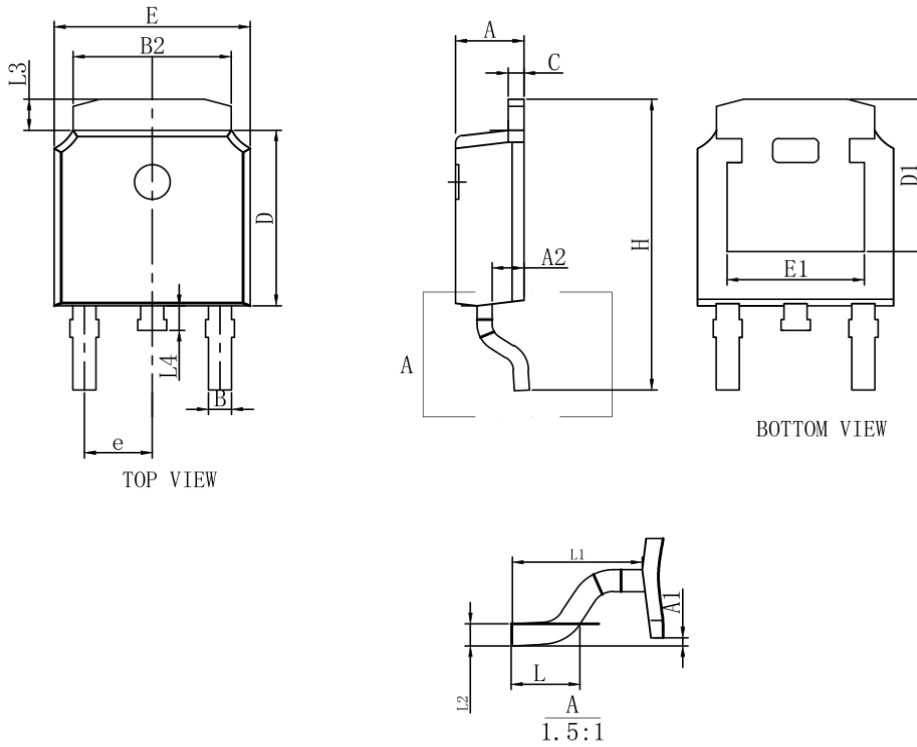

DIM	MILLIMETERS		
	MIN	NOM	MAX
A	2.15	2.30	2.45
A1	-	-	0.20
A2	0.90	1.07	1.17
B	0.68	0.78	0.88
B2	5.20	5.33	5.46
D	5.90	6.10	6.30
D1	5.30REF		
E	6.40	6.60	6.80
E1	4.63	4.83	5.03
e	2.286BSC		
H	9.85	10.10	10.35
L	1.30	1.50	1.70
L1	2.90REF		
L2	0.51BSC		
L3	0.88	1.08	1.28
L4	0.55	0.80	1.05

9. SOLDERING FOOTPRINT

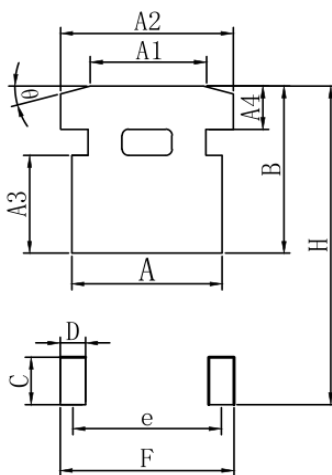

DIM	MIN(mm)
A	6.03
A1	4.50
A2	6.46
A3	4.10
A4	2.37
B	6.50
C	2.50
D	1.68
e	4.80
H	12.35
F	5.95

DISCLAIMER

- Curve guarantee in the specification. The curve of test items with electric parameter is used as quality guarantee. The curve of test items without electric parameter is used as reference only.
- Before you use our Products for new Porject, you are requested to carefully read this document and fully understand its contents. LRC shall not be in any way responsible or liable for failure, malfunction or accident arising from the use of any LRC's Products against warning, caution or note contained in this document.
- All information contained in this document is current as of the issuing date and subject to change without any prior notice. Before purchasing or using LRC's Products, please confirm the latest information with a LRC sales representative.

单击下面可查看定价，库存，交付和生命周期等信息

[>>LRC\(乐山无线电\)](#)