

DUAL PNP SMALL SIGNAL SURFACE MOUNT TRANSISTOR

FEATURE

- We declare that the material of product compliance with RoHS requirements.
- S- Prefix for Automotive and Other Applications Requiring Unique Site and Control Change Requirements; AEC-Q101 Qualified and PPAP Capable.

DEVICE MARKING AND ORDERING INFORMATION

Device	Marking	Shipping
LMBT5401DW1T1G S-LMBT5401DW1T1G	2L	3000/Tape&Reel
LMBT5401DW1T3G S-LMBT5401DW1T3G	2L	10000/Tape&Reel

MAXIMUM RATINGS

Rating	Symbol	Value	Unit
Collector–Emitter Voltage	V_{CE0}	-150	Vdc
Collector–Base Voltage	V_{CBO}	-160	Vdc
Emitter–Base Voltage	V_{EBO}	-5.0	Vdc
Collector Current — Continuous	I_C	-500	mAdc

THERMAL CHARACTERISTICS

Characteristic	Symbol	Max	Unit
Total Device Dissipation FR–5 Board, (1) $T_A = 25^\circ\text{C}$	P_D	225	mW
Derate above 25°C		1.8	mW/ $^\circ\text{C}$
Thermal Resistance, Junction to Ambient	$R_{\theta JA}$	556	$^\circ\text{C}/\text{W}$
Total Device Dissipation Alumina Substrate, (2) $T_A = 25^\circ\text{C}$	P_D	300	mW
Derate above 25°C		2.4	mW/ $^\circ\text{C}$
Thermal Resistance, Junction to Ambient	$R_{\theta JA}$	417	$^\circ\text{C}/\text{W}$
Junction and Storage Temperature	T_J, T_{stg}	-55 to +150	$^\circ\text{C}$

ELECTRICAL CHARACTERISTICS ($T_A = 25^\circ\text{C}$ unless otherwise noted.)

Characteristic	Symbol	Min	Max	Unit
----------------	--------	-----	-----	------

OFF CHARACTERISTICS

Collector–Emitter Breakdown Voltage(3) ($I_C = -1.0 \text{ mAdc}, I_B = 0$)	$V_{(BR)CEO}$	-150	—	Vdc
Collector–Base Breakdown Voltage ($I_C = -100 \mu\text{Adc}, I_E = 0$)	$V_{(BR)CBO}$	-160	—	Vdc
Emitter–Base Breakdown Voltage ($I_E = -10 \mu\text{Adc}, I_C = 0$)	$V_{(BR)EBO}$	-5.0	—	Vdc
Collector Cutoff Current ($V_{CB} = -120\text{Vdc}, I_E = 0$)	I_{CBO}	—	-50	nAdc
($V_{CB} = -120\text{Vdc}, I_E = 0, T_A = 100^\circ\text{C}$)		—	-50	μAdc

1. FR–5 = 1.0 x 0.75 x 0.062 in.
2. Alumina = 0.4 x 0.3 x 0.024 in. 99.5% alumina.
3. Pulse Test: Pulse Width = 300 μs , Duty Cycle = 2.0%.

LMBT5401DW1T1G S-LMBT5401DW1T1G

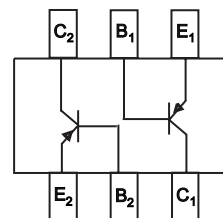
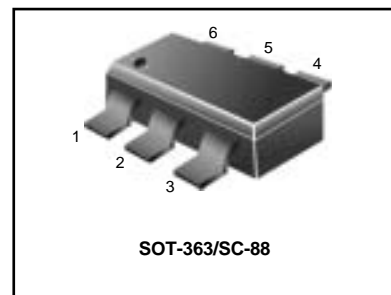

LMBT5401DW1T1G , S-LMBT5401DW1T1G

ELECTRICAL CHARACTERISTICS ($T_A = 25^\circ\text{C}$ unless otherwise noted) (Continued)

Characteristic	Symbol	Min	Max	Unit
ON CHARACTERISTICS (2)				
DC Current Gain ($I_C = -1.0\text{mA}$, $V_{CE} = -5.0\text{V}$)	h_{FE}	50	—	—
($I_C = -10\text{mA}$, $V_{CE} = -5.0\text{V}$)		60	240	
($I_C = -50\text{mA}$, $V_{CE} = -5.0\text{V}$)		50	—	
Collector–Emitter Saturation Voltage ($I_C = -10\text{mA}$, $I_B = -1.0\text{mA}$)	$V_{CE(sat)}$	—	-0.2	Vdc
($I_C = -50\text{mA}$, $I_B = -5.0\text{mA}$)		—	-0.5	
Base–Emitter Saturation Voltage ($I_C = -10\text{mA}$, $I_B = -1.0\text{mA}$)	$V_{BE(sat)}$	—	-1.0	Vdc
($I_C = -50\text{mA}$, $I_B = -5.0\text{mA}$)		—	-1.0	
SMALL–SIGNAL CHARACTERISTICS				
Current–Gain — Bandwidth Product ($I_C = -10\text{mA}$, $V_{CE} = -10\text{V}$, $f = 100\text{MHz}$)	f_T	100	300	MHz
Output Capacitance ($V_{CB} = -10\text{V}$, $I_E = 0$, $f = 1.0\text{MHz}$)	C_{obo}	—	6.0	pF
Small–Signal Current Gain ($I_C = -1.0\text{mA}$, $V_{CE} = -10\text{V}$, $f = 1.0\text{kHz}$)	h_{fe}	40	200	—
Noise Figure ($I_C = -200\mu\text{A}$, $V_{CE} = -5.0\text{V}$, $R_s = 10\Omega$, $f = 1.0\text{kHz}$)	NF	—	8.0	dB

LMBT5401DW1T1G , S-LMBT5401DW1T1G

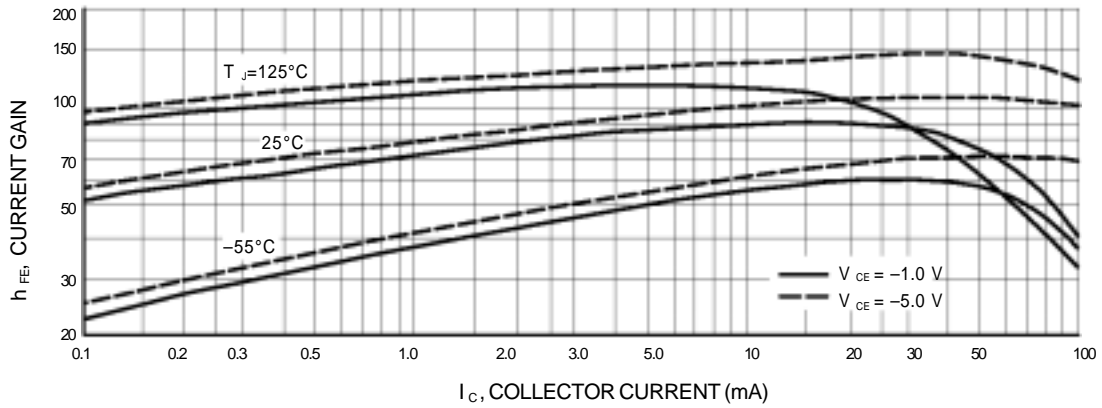

Figure 1. DC Current Gain

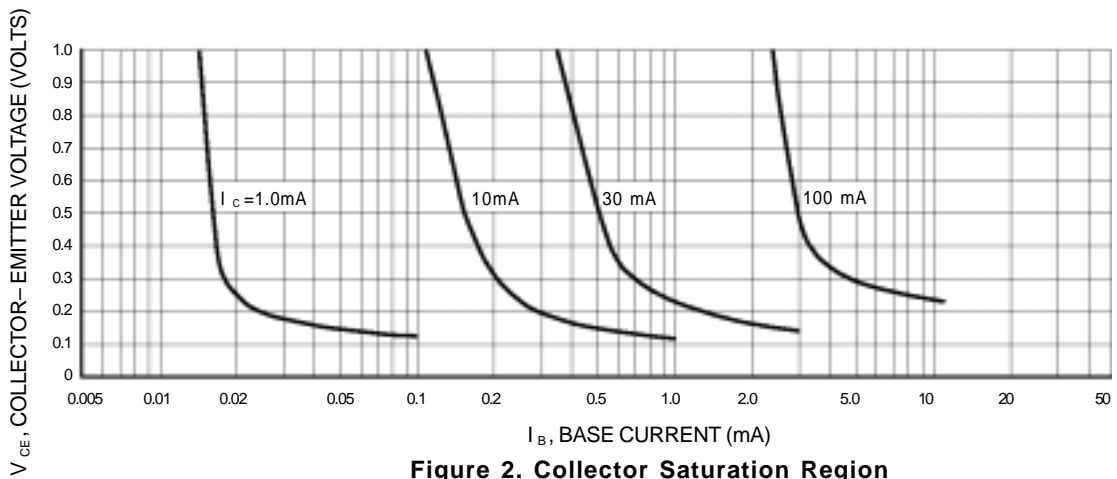

Figure 2. Collector Saturation Region

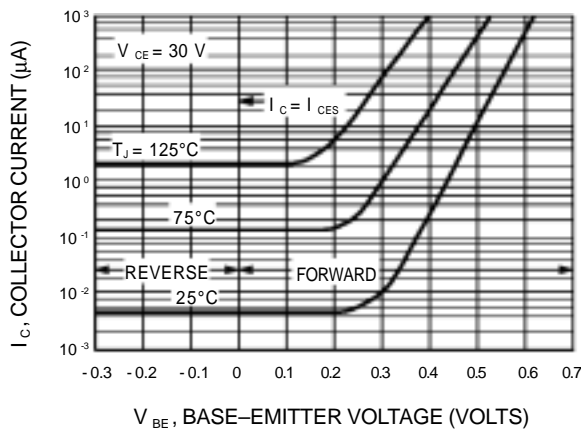

Figure 3. Collector Cut-Off Region

LMBT5401DW1T1G , S-LMBT5401DW1T1G

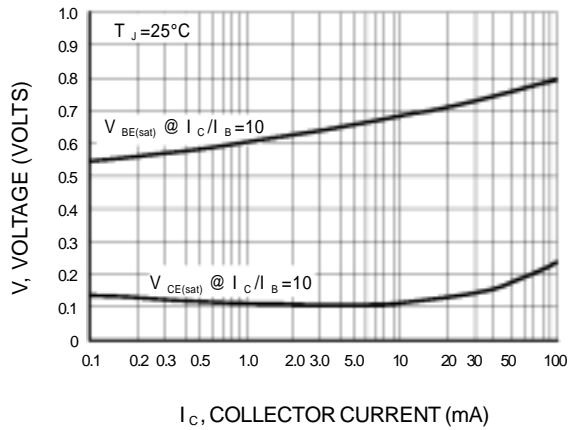

Figure 4. "On" Voltages

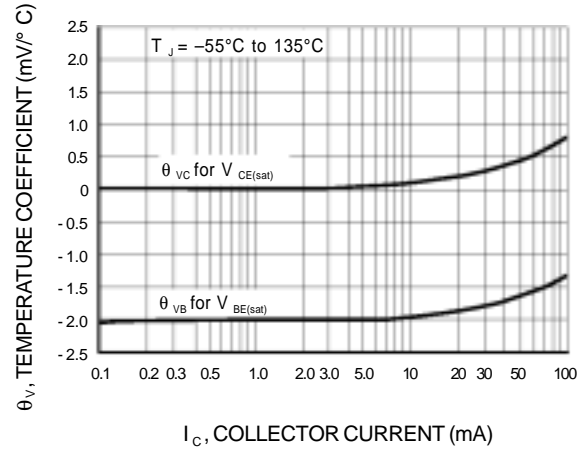

Figure 5. Temperature Coefficients

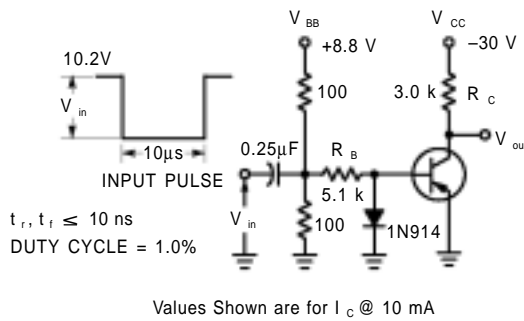

Figure 6. Switching Time Test Circuit

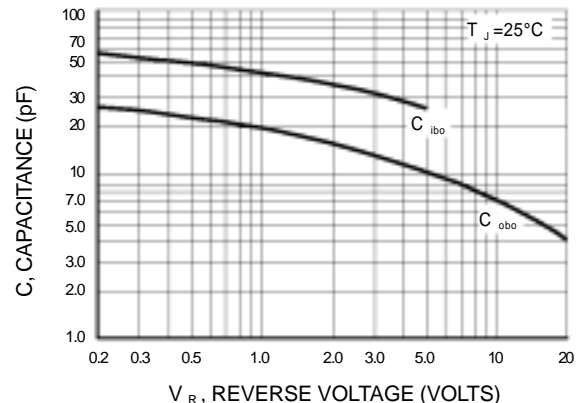

Figure 7. Capacitances

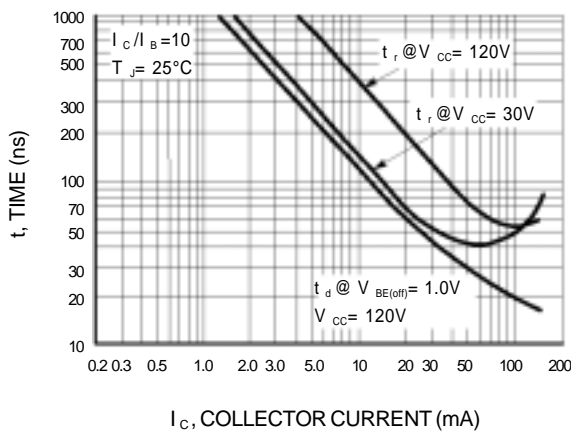

Figure 8. Turn-On Time

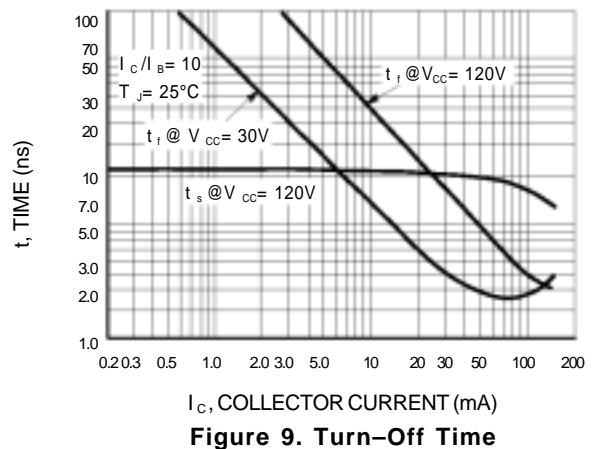
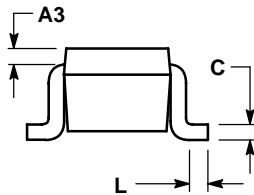
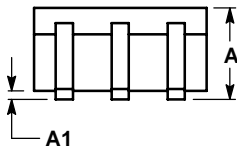
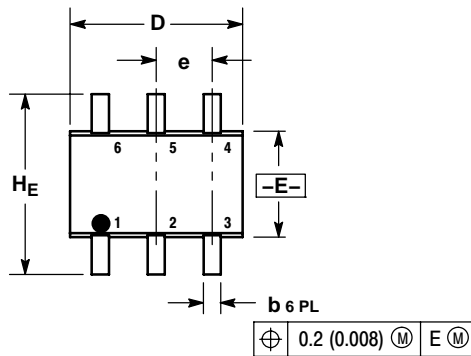

Figure 9. Turn-Off Time

LMBT5401DW1T1G , S-LMBT5401DW1T1G

SC-88



NOTES:

1. DIMENSIONING AND TOLERANCING PER ANSI Y14.5M, 1982.
2. CONTROLLING DIMENSION: INCH.
3. 419B-01 OBSOLETE, NEW STANDARD 419B-02.

DIM	MILLIMETERS			INCHES		
	MIN	NOM	MAX	MIN	NOM	MAX
A	0.80	0.95	1.10	0.031	0.037	0.043
A1	0.00	0.05	0.10	0.000	0.002	0.004
A3	0.20 REF			0.008 REF		
b	0.10	0.21	0.30	0.004	0.008	0.012
C	0.10	0.14	0.25	0.004	0.005	0.010
D	1.80	2.00	2.20	0.070	0.078	0.086
E	1.15	1.25	1.35	0.045	0.049	0.053
e	0.65 BSC			0.026 BSC		
L	0.10	0.20	0.30	0.004	0.008	0.012
HE	2.00	2.10	2.20	0.078	0.082	0.086

GENERIC MARKING DIAGRAM*

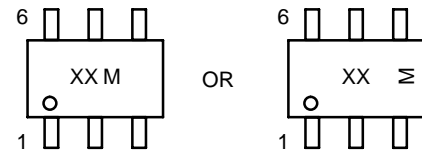

XX = Specific Device Code
M = Date Code

单击下面可查看定价，库存，交付和生命周期等信息

[>>LRC\(乐山无线电\)](#)