

# D4SB10 Thru D4SB100

## High Current Glass Passivated Molding Single-Phase Bridge Rectifier

Reverse Voltage 100 to 1000V Forward Current 6.0 A

### FEATURES

- Plastic Package has Underwriters Laboratory Flammability Classification 94V-0
- High current capacity with small package
- Glass passivated chip junctions
- Superior thermal conductivity
- High IFSM

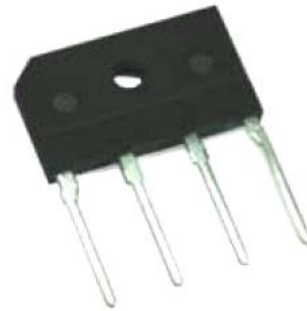

### 1. Maximum & Thermal Characteristics Ratings at 25°C ambient temperature unless otherwise specified.

Parameter Symbol		Symbol	D4SB10	D4SB20	D4SB40	D4SB60	D4SB80	D4SB100	Unit
Maximum repetitive voltage		VRRM	100	200	400	600	800	1000	V
Maximum RMS Voltage		VRMS	70	140	280	420	560	700	V
Maximum DC Blocking Voltage		VDC	100	200	400	600	800	1000	V
Maximum DC reverse current TA=25 °C		IR	10						μA
at rated DC blocking voltage TA=125°C			500						
Maximum average forward rectified output current at	With heatsink Tc=100°C	Io	6.0						A
	Without heatsink Ta=25°C		2.8						A
Peak forward surge current 8.3ms single half sine-wave superimposed on rated load		IFSM	175						A
Rating of fusing (t<8.3ms)		I <sup>2</sup> t	127						A <sup>2</sup> sec
Dielectric strength terminals to case, AC 1 minute Current 1mA		Vdia	2.5						KV
Max instantaneous forward voltage at 3.0A		VF	1.05						V
Operating junction temperature		TJ	-55~150						°C
Maximum thermal on P.C.B. without heat-sink		RθJA	Max 22						°C/W
resistance per leg on Al plate heat-sink		RθJC	Max 3.4						
Storage temperature		Tstg	-55~150						°C
Mounting torque		Tor	Rating Torque : 0.8						N.m

# D4SB10 Thru D4SB100

## 2. Ratings and Characteristic Curves (TA = 25°C unless otherwise noted)

Fig. 1 Derating Curve

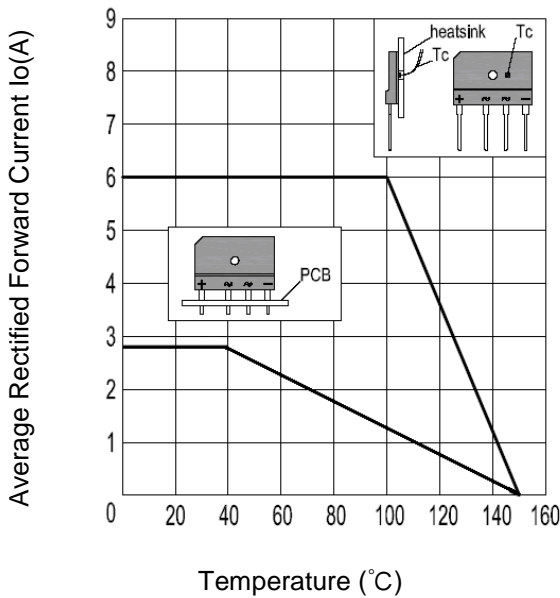

Fig.2 Typical Reverse Characteristics

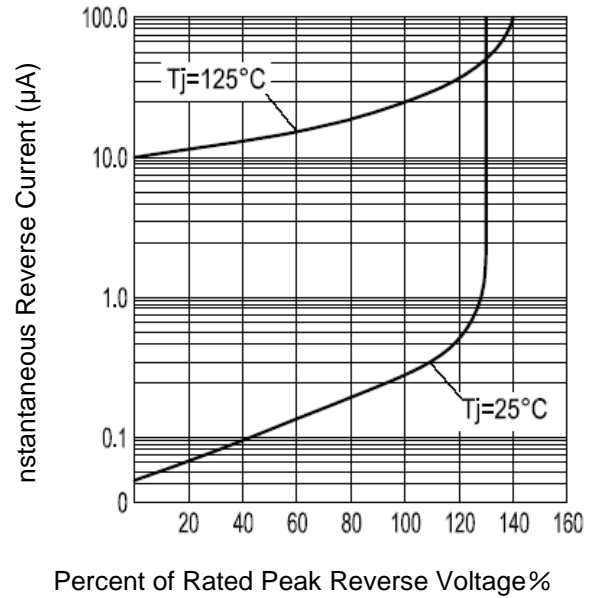

Fig.3 Forward Voltage

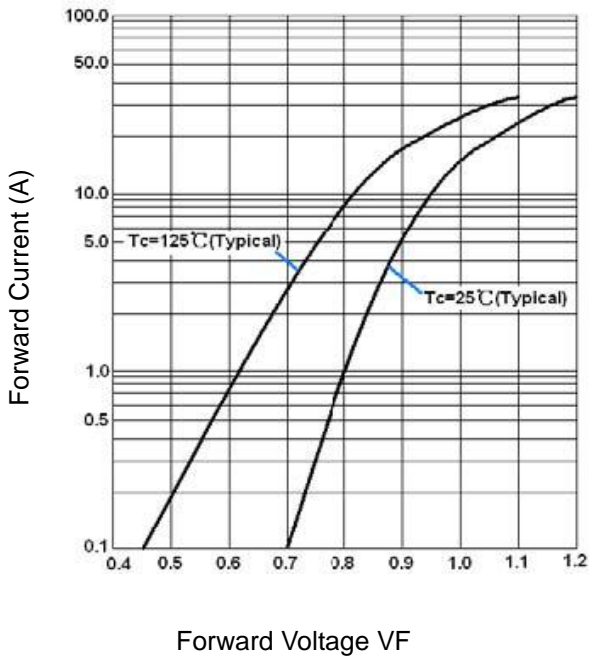
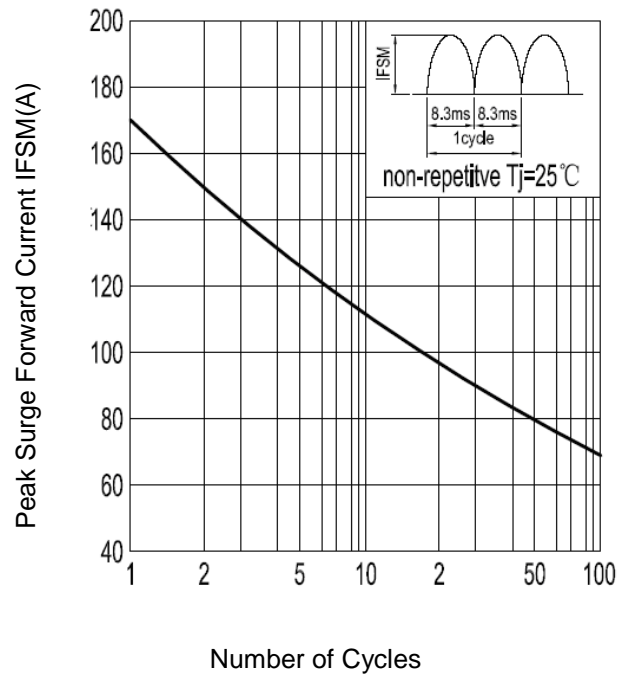
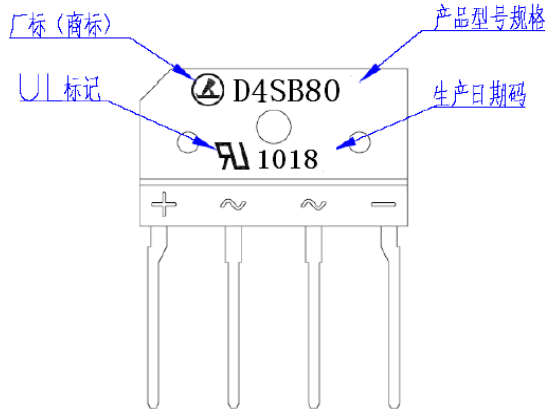

Fig.4 Peak Surge Forward Capability



# D4SB10 Thru D4SB100

## 3. Marking Identification



### Note:

生产日期码包含4位数字，例如“1018”，前两个数字“10”表示为2010年，另外二个数字“18”是指第10周，即表示该产品为2010年18周生产。

型号:

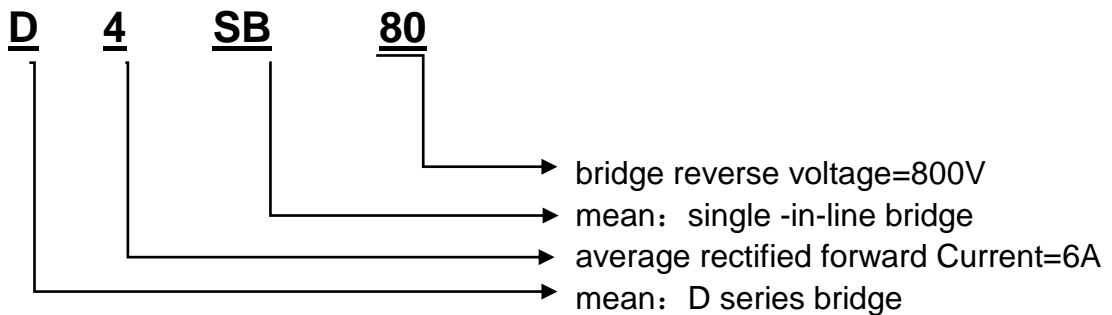

## 4. Dimension

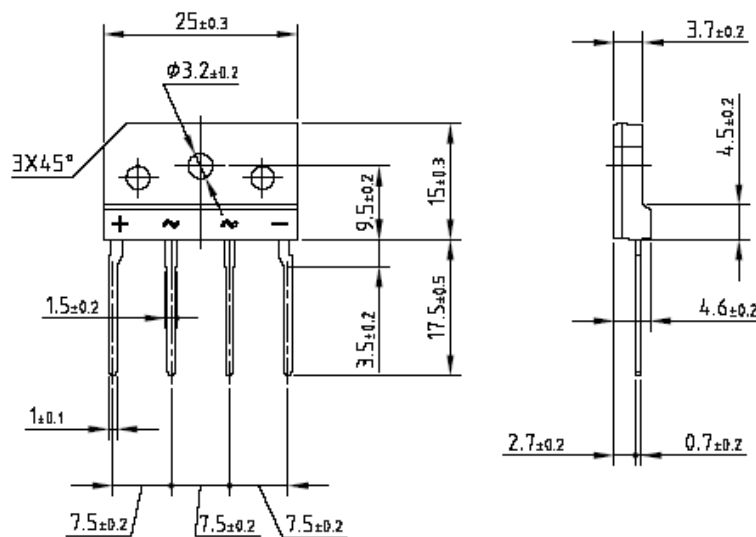

单击下面可查看定价，库存，交付和生命周期等信息

[>>LRC\(乐山无线电\)](#)