

Transient Voltage Suppressors for ESD Protection

General Description

The LESD5Z7.0T1G is designed to protect voltage sensitive components from ESD and transient voltage events. Excellent clamping capability, low leakage, and fast response time, make these parts ideal for ESD protection on designs where board space is at a premium.

Applications

- Cellular phones
- Portable devices
- Digital cameras
- Power supplies

Features

- Small Body Outline Dimensions
- Low Body Height
- Stand-off Voltage: 7 V
- Peak Power up to 116 Watts @ 8 x 20 us Pulse
- Low Leakage
- Response Time is Typically < 1 ns
- ESD Rating of Class 3 per Human Body Model
- IEC61000-4-2 Level 4 ESD Protection
- IEC61000-4-4 Level 4 EFT Protection
- We declare that the material of product compliance with RoHS requirements.
- S- Prefix for Automotive and Other Applications Requiring Unique Site and Control Change Requirements; AEC-Q101 Qualified and PPAP Capable.

LESD5Z7.0T1G
S-LESD5Z7.0T1G

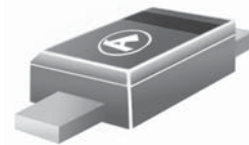

SOD-523

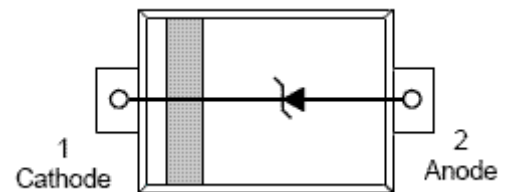

ORDERING INFORMATION

Device	Package	Shipping
LESD5Z7.0T1G S-LESD5Z7.0T1G	SOD-523	3000/Tape & Reel

Absolute Ratings (T_{amb}=25°C)

Symbol	Parameter	Value	Units
P _{PP}	Peak Pulse Power (t _p = 8/20μs)	116	W
T _L	Maximum lead temperature for soldering during 10s	260	°C
T _{stg}	Storage Temperature Range	-55 to +150	°C
T _{op}	Operating Temperature Range	-40 to +125	°C
T _j	Maximum junction temperature	150	°C
	IEC61000-4-2 (ESD)	air discharge contact discharge	± 15 ± 8 KV

LESD5Z7.0T1G, S-LESD5Z7.0T1G

Electrical Parameter

($T_A = 25^\circ\text{C}$ unless otherwise noted)

Symbol	Parameter
I_{PP}	Maximum Reverse Peak Pulse Current
V_C	Clamping Voltage @ I_{PP}
V_{RWM}	Working Peak Reverse Voltage
I_R	Maximum Reverse Leakage Current @ V_{RWM}
V_{BR}	Breakdown Voltage @ I_T
I_T	Test Current
I_F	Forward Current
V_F	Forward Voltage @ I_F
P_{pk}	Peak Power Dissipation
C	Capacitance @ $V_R = 0$ and $f = 1.0$ MHz

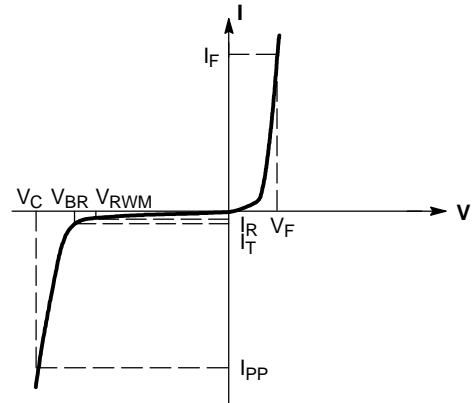

Electrical Characteristics

Ratings at 25°C ambient temperature unless otherwise specified. $V_F = 0.9\text{V}$ at $I_F = 10\text{mA}$

Device	Device Marking	V_{RWM} (V)	I_R (μA) @ V_{RWM}	V_{BR} (V) @ I_T (Note 1)	I_T	V_C (V) @ $I_{PP}=5\text{A}^*$	V_C (V) @ Max I_{PP}^*	I_{PP} (A)*	P_{PK} (W)*	C (pF)
		Max	Max	Min	mA	Typ	Max	Max	Max	Typ
LESD5Z7.0T1G	ZH	7.0	1.0	7.5	1.0	13.5	14.5	8.8	116	65

*Surge current waveform per Figure 1.

1. V_{BR} is measured with a pulse test current I_T at an ambient temperature of 25°C .

LESD5Z7.0T1G, S-LESD5Z7.0T1G

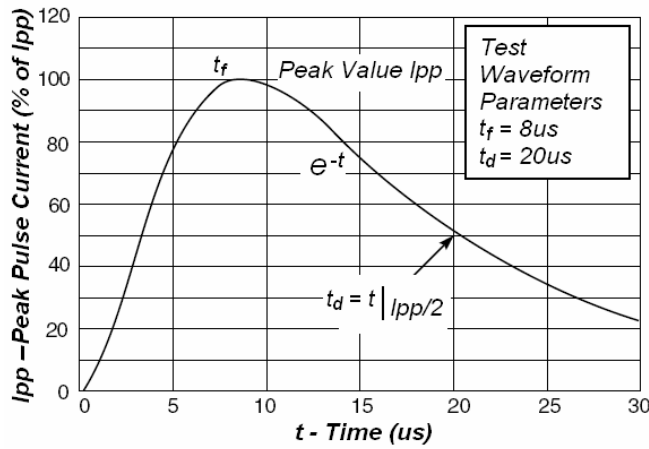

Fig1. Pulse Waveform

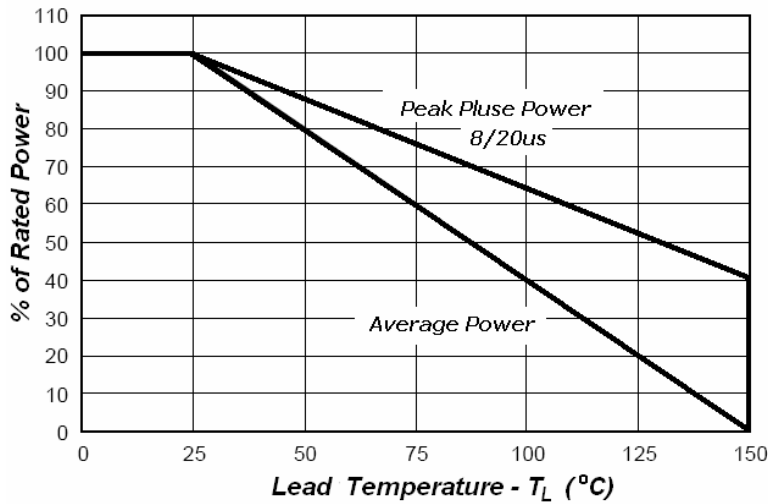

Fig3. Power Derating

Application Note

Electrostatic discharge (ESD) is a major cause of failure in electronic systems. Transient Voltage Suppressors (TVS) are an ideal choice for ESD protection. They are capable of clamping the incoming transient to a low enough level such that damage to the protected semiconductor is prevented.

Surface mount TVS offer the best choice for minimal lead inductance. They serve as parallel protection elements, connected between the signal line to ground. As the transient rises above the operating voltage of the device, the TVS becomes a low impedance path diverting the transient current to ground. The LESD5Z7.0T1G is the ideal board level protection of ESD sensitive semiconductor components.

The tiny SOD523 package allows design flexibility in the design of high density boards where the space saving is at a premium. This enables to shorten the routing and contributes to hardening against ESD.

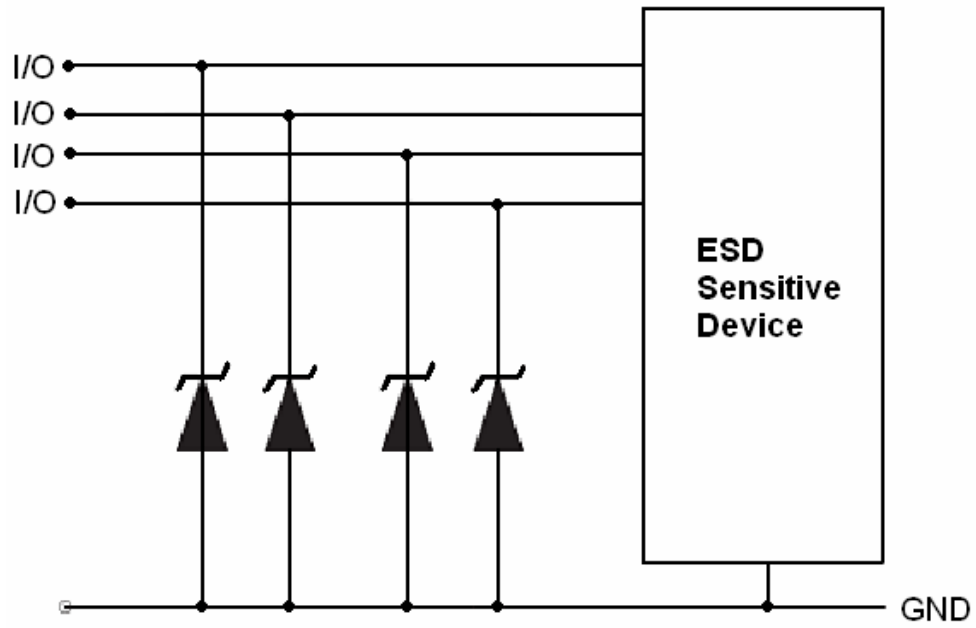
LESD5Z7.0T1G, S-LESD5Z7.0T1G

LESD5Z7.0T1G, S-LESD5Z7.0T1G

OUTLINE AND DIMENSIONS

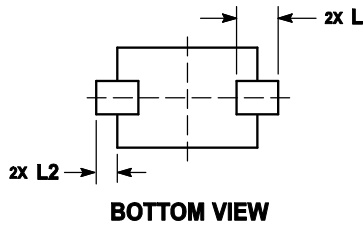
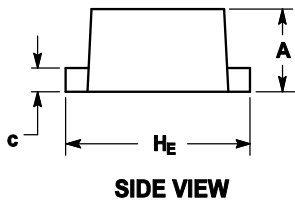
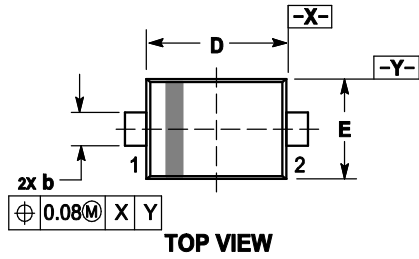

Notes:

1. DIMENSIONING AND TOLERANCING PER ANSI Y14.5M, 1982.
2. CONTROLLING DIMENSION: MILLIMETERS.
3. MAXIMUM LEAD THICKNESS INCLUDES LEAD FINISH. MINIMUM LEAD THICKNESS IS THE MINIMUM THICKNESS OF BASE MATERIAL.
4. DIMENSIONS D AND E DO NOT INCLUDE MOLD FLASH, PROTRUSIONS OR GATE BURRS.

DIM	MILLIMETERS			INCHES		
	MIN	NOM	MAX	MIN	NOM	MAX
A	0.50	0.60	0.70	0.020	0.024	0.028
b	0.25	0.30	0.35	0.010	0.012	0.014
c	0.07	0.14	0.20	0.003	0.006	0.008
D	1.10	1.20	1.30	0.043	0.047	0.051
E	0.70	0.80	0.90	0.028	0.031	0.035
H _E	1.50	1.60	1.70	0.059	0.063	0.067
L	0.30 REF			0.012 REF		
L ₂	0.15	0.20	0.25	0.006	0.008	0.010

SOLDERING FOOTPRINT

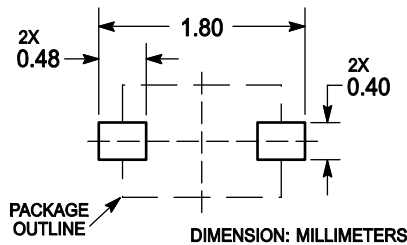

EMBOSSED TAPE AND REEL DATA FOR DISCRETES CARRIER TAPE SPECIFICATIONS

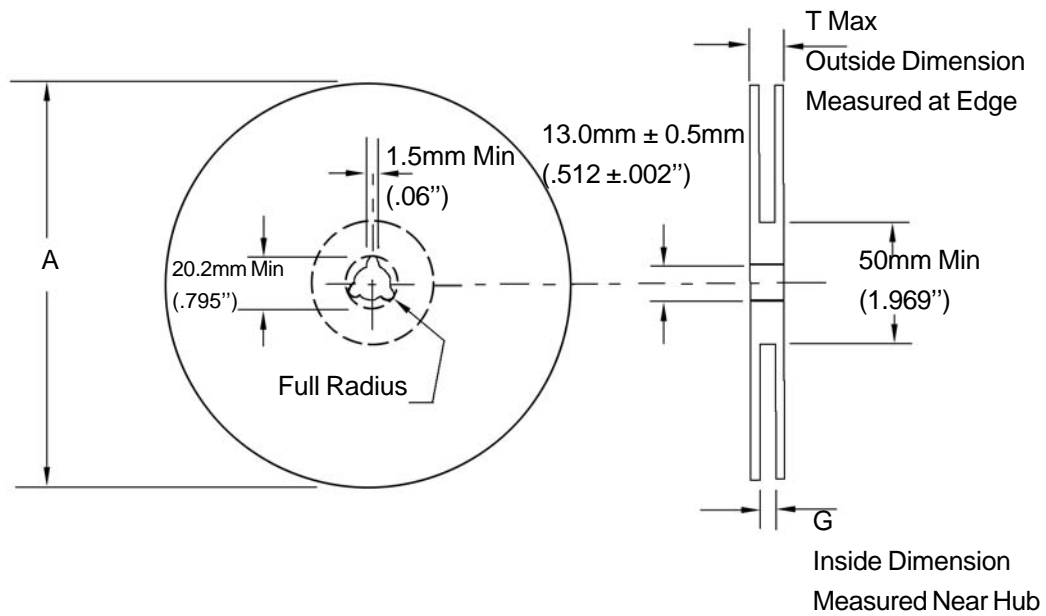

Size	A Max	G	T Max
8 mm	178.0mm (7.0")	8.4mm+1.5mm, -0.0 (.33"+.039", -0.00)	10.9mm (.43")

Reel Dimensions

Metric Dimensions Govern — English are in parentheses for reference only

Storage Conditions

Temperature: 5 to 40 Deg.C (20 to 30 Deg. C is preferred)

Humidity: 30 to 80 RH (40 to 60 is preferred)

Recommended Period: One year after manufacturing

(This recommended period is for the soldering condition only. The characteristics and reliabilities of the products are not restricted to this limitation)

Shipment Specification

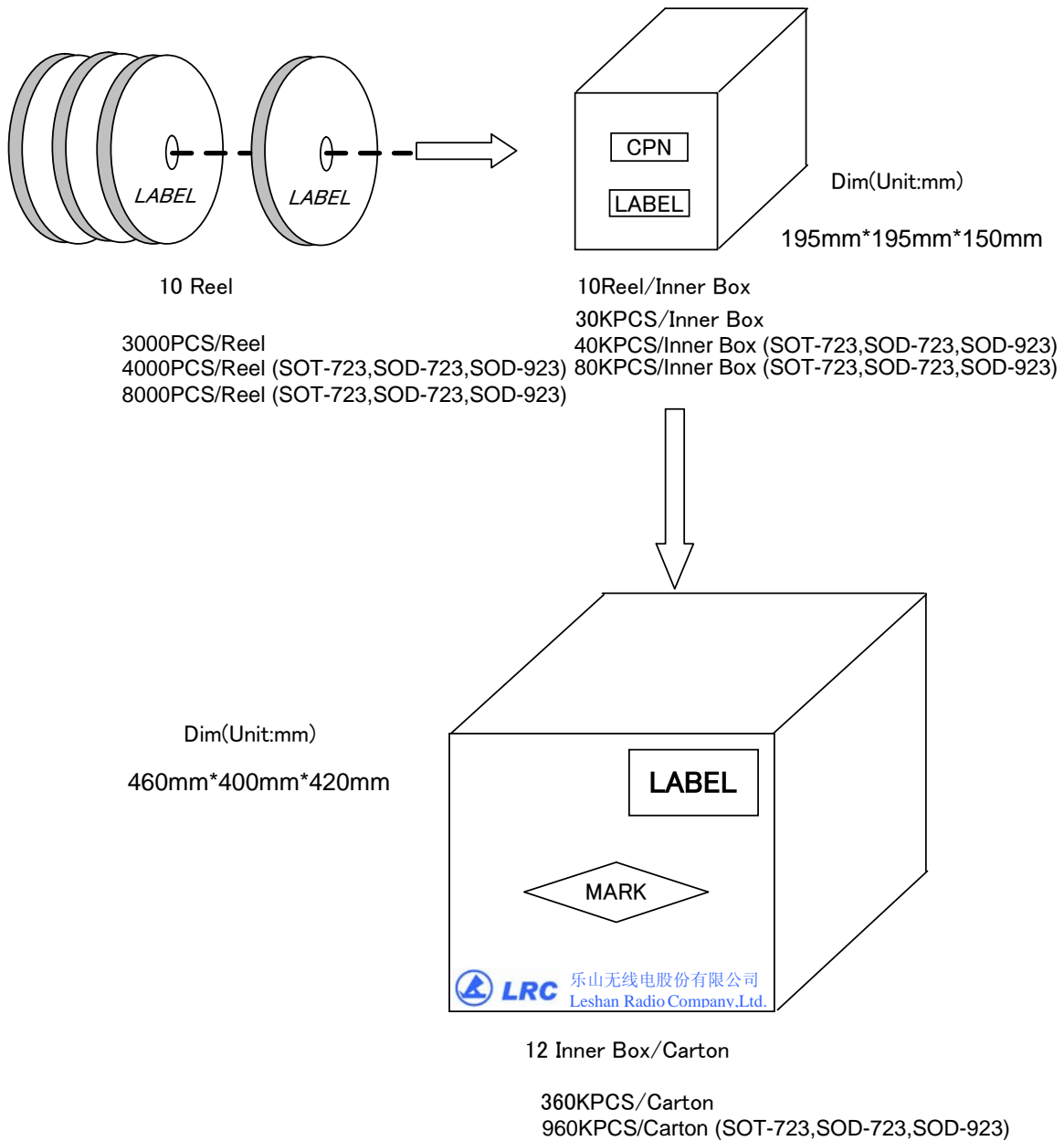

单击下面可查看定价，库存，交付和生命周期等信息

[>>LRC\(乐山无线电\)](#)

[>>点击查看相关商品](#)