

L2N7002SLT1G

S-L2N7002SLT1G

Small Signal MOSFET

380 mAmps, 60V N-Channel SOT-23

1. FEATURES

- We declare that the material of product compliance with RoHS requirements and Halogen Free.
- S- prefix for automotive and other applications requiring unique site and control change requirements; AEC-Q101 qualified and PPAP capable.
- ESD protected
- Low RDS(on)

2. APPLICATIONS

- Low side load switch
- Level shift circuits
- DC-DC converter
- Portable applications i.e. DSC, PDA, Cell Phone, etc.

3. DEVICE MARKING AND ORDERING INFORMATION

Device	Marking	Shipping
L2N7002SLT1G	701	3000/Tape&Reel
L2N7002SLT3G	701	10000/Tape&Reel

4. MAXIMUM RATINGS(Ta = 25°C)

Parameter	Symbol	Limits	Unit
Drain-Source Voltage	VDSS	60	V
Gate-Source Voltage	VGS	±20	V
Drain Current	ID		mA
- Steady State TA = 25°C		320	
TA = 85°C		230	
- t<5s TA = 25°C		380	
TA = 85°C		270	
Pulsed Drain Current (tp=10µs)	IDM	1.5	A
Source Current (Body Diode)	IS	300	mA

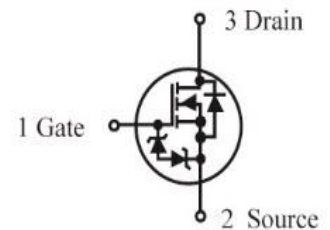
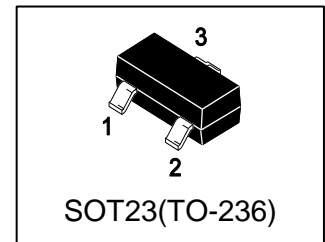

5. THERMAL CHARACTERISTICS

Parameter	Symbol	Limits	Unit
Total Device Dissipation(Note 1)	PD		mW
– Steady State		300	
– t<5s		420	
Junction-to-Ambient(Note 1)	R θ JA		°C/W
– Steady State		417	
– t<5s		300	
Lead Temperature for Soldering Purposes (1/8 " from case for 10 s)	TL	260	°C
Junction and Storage temperature	TJ, Tstg	-55~+150	°C
Gate-Source ESD Rating(HBM, Method 3015)	ESD	2000	V

6. ELECTRICAL CHARACTERISTICS (Ta= 25°C)

OFF CHARACTERISTICS

Characteristic	Symbol	Min.	Typ.	Max.	Unit
Drain-Source Breakdown Voltage (VGS = 0, ID = 250 μ A)	VBRDSS	60	-	-	V
Drain-to-Source Breakdown Voltage Temperature Coefficient	VBRDSS/TJ	-	71	-	mV/°C
Zero Gate Voltage Drain Current (VGS = 0, VDS = 60 V)	IDSS	-	-	1.0	μ A
(VGS = 0, VDS = 50 V)				500	
Zero Gate Voltage Drain Current (VGS = 0, VDS = 50 V)	IDSS	-	-	100	nA
Gate-Body Leakage Current, Forward (VGS = 20 V)	IGSSF	-	-	10	μ A
Gate-Body Leakage Current, Reverse (VGS = -20 V)	IGSSR	-	-	-10	μ A

ON CHARACTERISTICS (Note 2)

Characteristic	Symbol	Min.	Typ.	Max.	Unit
Gate Threshold Voltage (VDS = VGS, ID = 250 μ A)	VGS(th)	1.0	-	2.0	V
Negative Threshold Temperature Coefficient	VGS(TH)/TJ	-	4	-	mV/°C
Static Drain-Source On-State Resistance (VGS = 10 V, ID = 500 mA)	RDS(on)	-	-	2.8	Ω
(VGS = 4.5 V, ID = 200 mA)				3.2	
Forward Transconductance (VDS = 5.0 V, ID = 200 mA)	gfs	80	-	-	mS

DYNAMIC CHARACTERISTICS

Characteristic	Symbol	Min.	Typ.	Max.	Unit
Input Capacitance (VDS = 25 V, VGS = 0, f = 1.0 MHz)	Ciss	-	-	35	pF
Output Capacitance (VDS = 25 V, VGS = 0, f = 1.0 MHz)	Coss	-	-	10	pF
Reverse Transfer Capacitance (VDS = 25 V, VGS = 0, f = 1.0 MHz)	Crss	-	-	5	pF
Total Gate Charge	VGS = 4.5 V, VDS = 10 V; ID = 500 mA	QG(TOT)	-	0.44	nC
Gate-to-Source Charge		QGS	-	0.2	
Gate-to-Drain Charge		QGD	-	0.1	

1. FR-4 = 1.0×0.75×0.062 in.

 2. Pulse Test: Pulse Width \leq 300 μ s, Duty Cycle \leq 2.0%.

6. ELECTRICAL CHARACTERISTICS (Ta= 25°C)(Con.)

SWITCHING CHARACTERISTICS

Turn-On Delay Time	VDS = 30 V, VGEN = 10 V, ID = 500 mA, RG = 25Ω ,RL =60Ω	td(on)	-	2.7	-	ns
Rise Time		tr	-	2.5	-	
Turn-Off Delay Time		td(off)	-	13	-	
Fall Time		tf	-	8	-	

BODY-DRAIN DIODE RATINGS

Diode Forward On-Voltage (IS = 0.5A, VGS = 0 V)	VSD	-	0.85	-	V
--	-----	---	------	---	---

7. ELECTRICAL CHARACTERISTICS CURVES

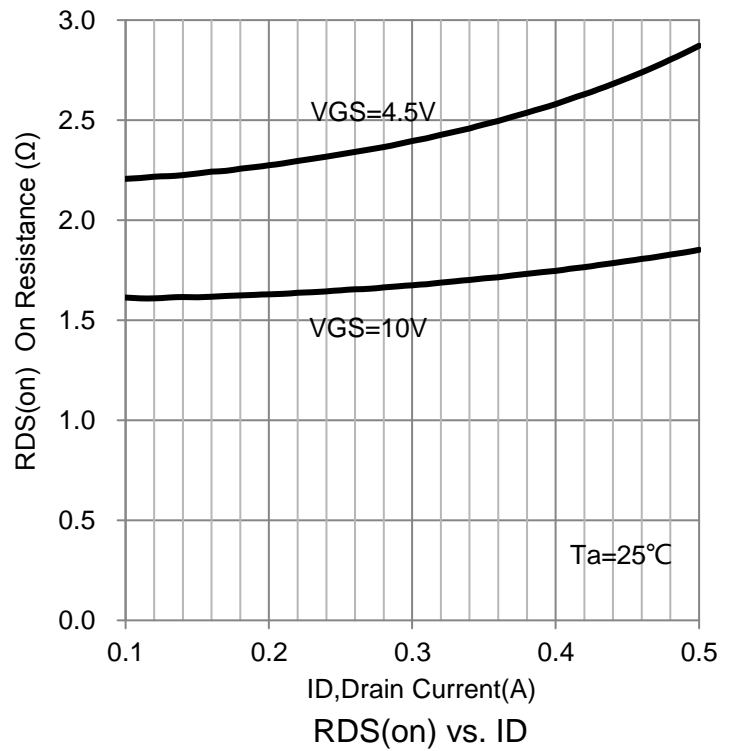
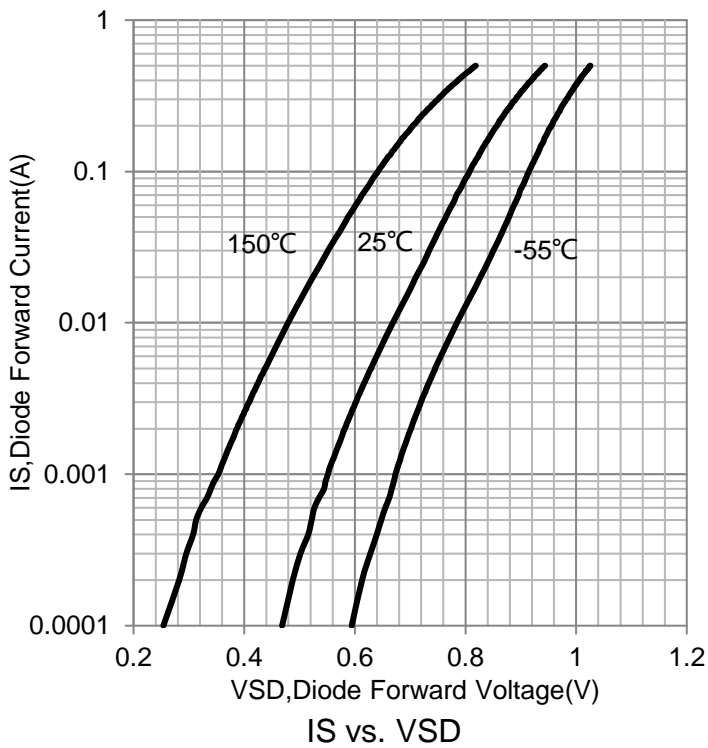
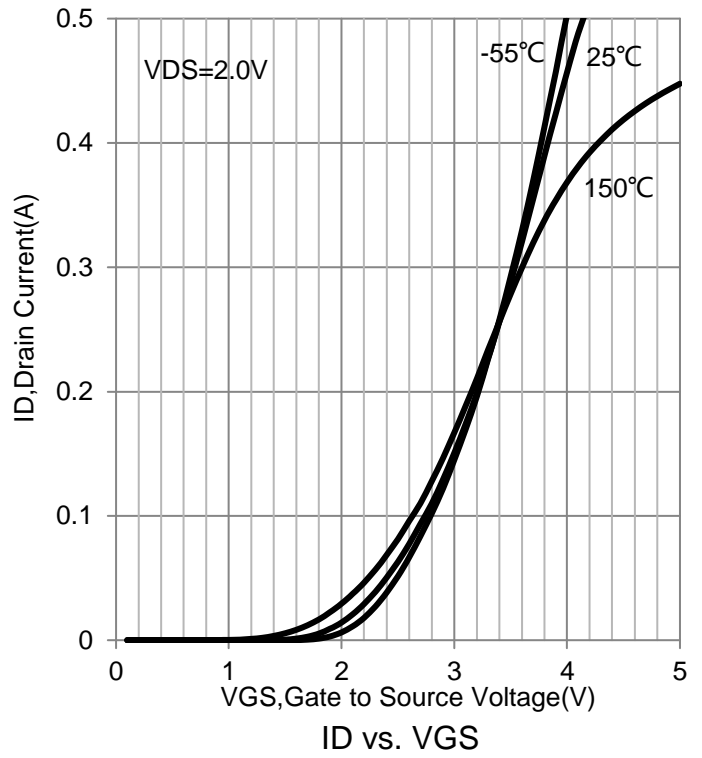
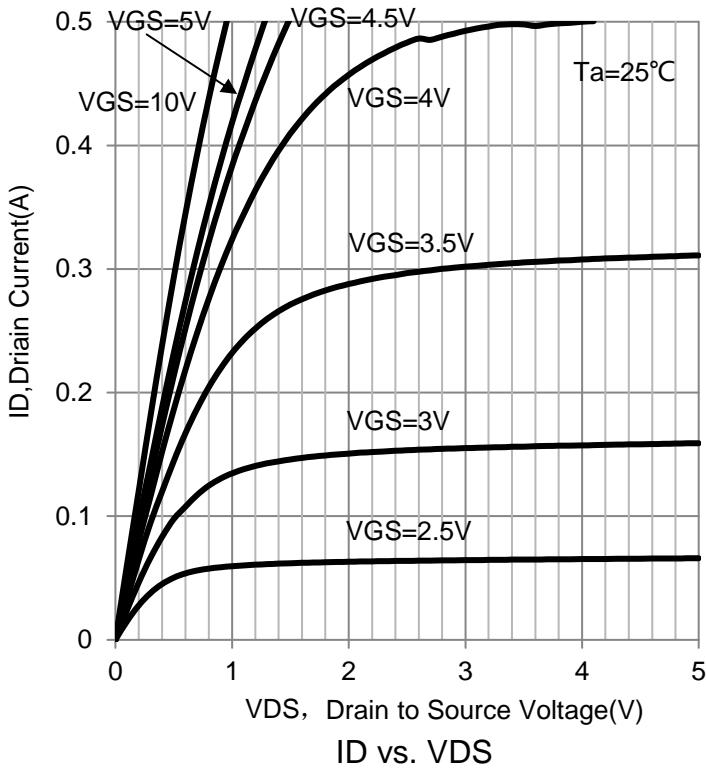

7. ELECTRICAL CHARACTERISTICS CURVES(Con.)

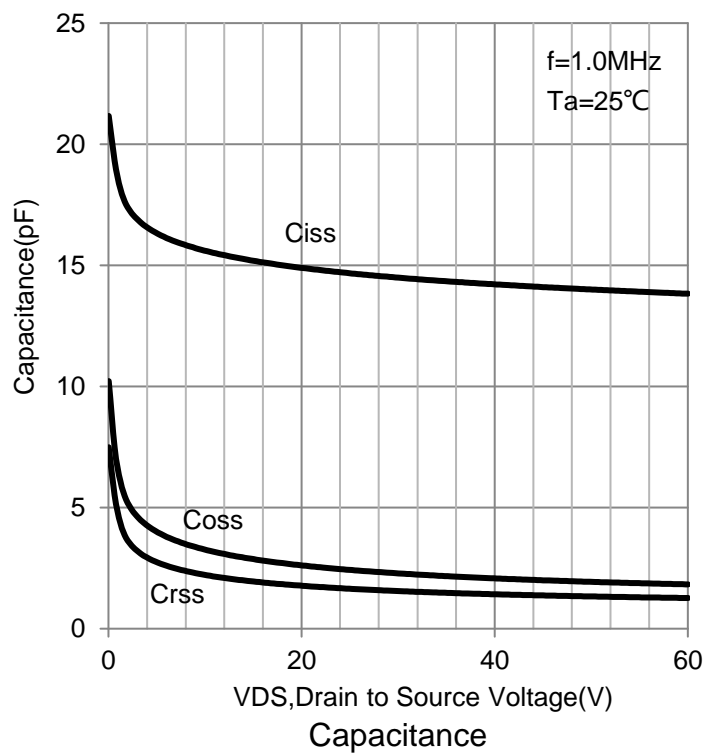
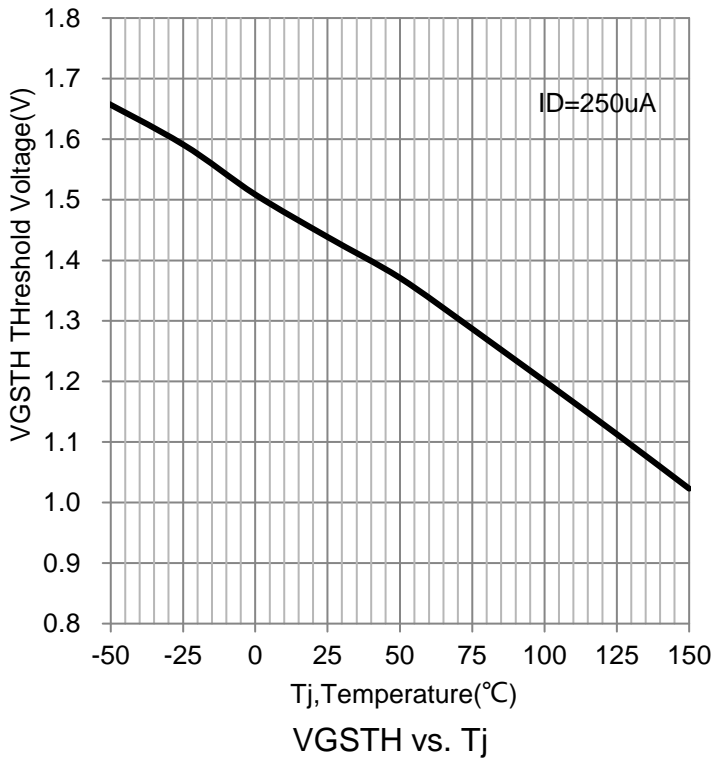
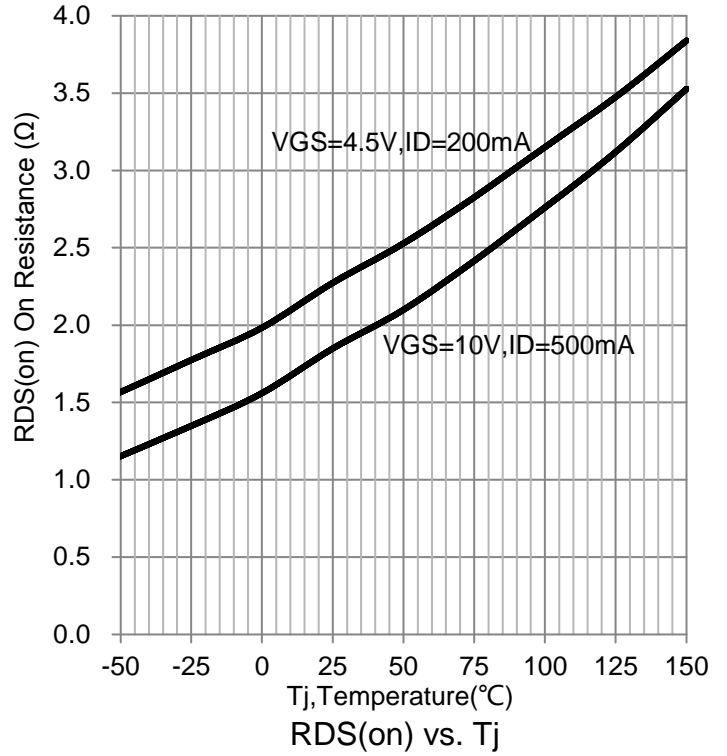
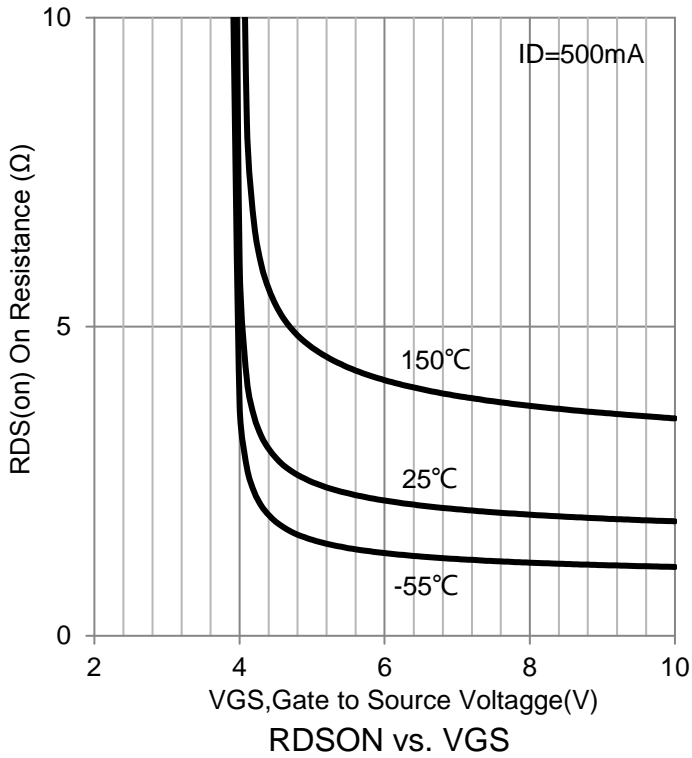

8. OUTLINE AND DIMENSIONS

Notes:

1. DIMENSIONING AND TOLERANCING PER ANSI Y14.5M, 1982.
2. CONTROLLING DIMENSION: MILLIMETERS.
3. MAXIMUM LEAD THICKNESS INCLUDES LEAD FINISH. MINIMUM LEAD THICKNESS IS THE MINIMUM THICKNESS OF BASE MATERIAL.
4. DIMENSIONS D AND E1 DO NOT INCLUDE MOLD FLASH, PROTRUSIONS OR GATE BURRS.

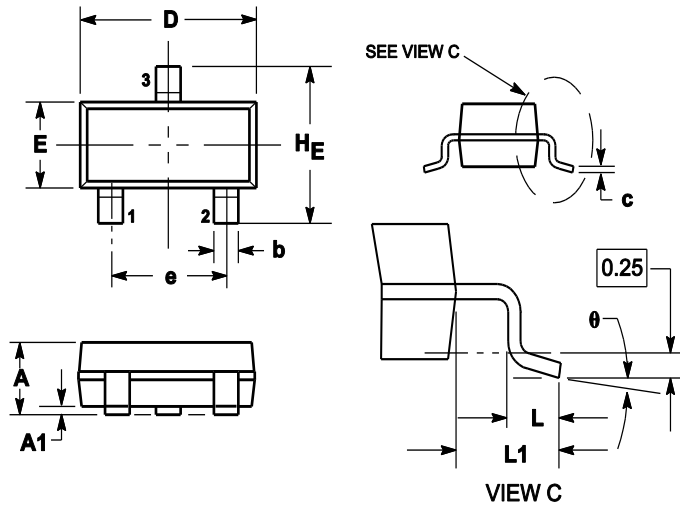

DIM	MILLIMETERS			INCHES		
	MIN	NOM	MAX	MIN	NOM	MAX
A	0.89	1	1.11	0.035	0.04	0.044
A1	0.01	0.06	0.1	0.001	0.002	0.004
b	0.37	0.44	0.5	0.015	0.018	0.02
c	0.09	0.13	0.18	0.003	0.005	0.007
D	2.80	2.9	3.04	0.11	0.114	0.12
E	1.20	1.3	1.4	0.047	0.051	0.055
e	1.78	1.9	2.04	0.07	0.075	0.081
L	0.10	0.2	0.3	0.004	0.008	0.012
L1	0.35	0.54	0.69	0.014	0.021	0.029
HE	2.10	2.4	2.64	0.083	0.094	0.104
θ	0°	---	10°	0°	---	10°

9. SOLDERING FOOTPRINT

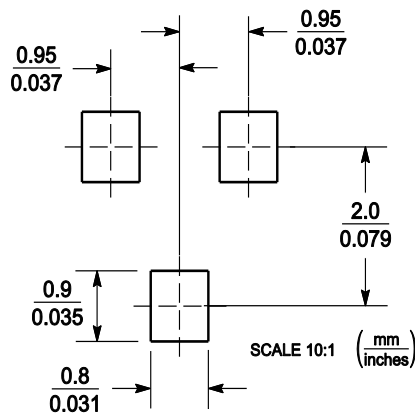

单击下面可查看定价，库存，交付和生命周期等信息

[>>LRC\(乐山无线电\)](#)