

# LESD11D12T5GESD PROTECTION DIODE

## Discription

The LESD11D12T5G is designed to protect voltage sensitive components from ESD. Excellent clamping capability, low leakage, and fast response time provide best in class protection on designs that are exposed to ESD. Because of its small size, it is suited for use in cellular phones, MP3 players, digital cameras and many other portable applications where board space is at a premium.

## Applications

- | Cellular phones audio
- | MP3 players
- | Digital cameras
- | Portable applications
- | mobile telephone

## Features

- | Small Body Outline Dimensions: 0.61 mm x 0.31 mm
- | Low Body Height! 0.28 mm
- | Low Leakage
- | Response Time is Typically < 1 ns
- | ESD Rating of Class 3 (> 16 kV) per Human Body Model
- | IEC61000-4-2 Level 4 ESD Protection
- | We declare that the material of product compliance with RoHS requirements.

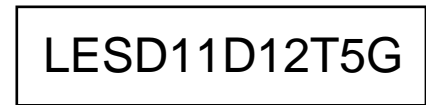

DFN0603-DL

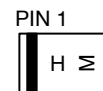

H = Specific Device Code  
M = Month Code

## Ordering information

Device	Marking	Shipping
LESD11D12T5G	H	15000/Tape&Reel

## MAXIMUM RATINGS

Rating	Symbol	Value	Unit
IEC 61000-4-2 (ESD) Air Contact Contact discharge		±15 ±8	kV kV
ESD Voltage Per Human Body Model		16	kV
Total Power Dissipation on FR-5 Board (Note 1) @ T <sub>A</sub> =25°C	PD	200	Mw
Junction and Storage Temperature Range	T <sub>J</sub> ,T <sub>STG</sub>	-55 to 150	°C
Lead Solder Temperature – Maximum (10 Second Duration)	TL	260	°C

Stresses exceeding Maximum Ratings may damage the device. Maximum Rating are stress ratings only. Functional operation above the Recommended Operating Conditions is not implied. Extended exposure to stresses above the Recommended Operating Conditions may affect device reliability.

1. FR-5 = 1.0\*0.75\*0.62 in.

# LESD11D12T5G

## ELECTRICAL CHARACTERISTICS

( $T_A = 25^\circ\text{C}$  unless otherwise noted)

Symbol	Parameter
$I_{PP}$	Maximum Reverse Peak Pulse Current
$V_C$	Clamping Voltage @ $I_{PP}$
$V_{RWM}$	Working Peak Reverse Voltage
$I_R$	Maximum Reverse Leakage Current @ $V_{RWM}$
$V_{BR}$	Breakdown Voltage @ $I_T$
$I_T$	Test Current
$I_F$	Forward Current
$V_F$	Forward Voltage @ $I_F$
$P_{pk}$	Peak Power Dissipation
C	Max. Capacitance @ $V_R = 0$ and $f = 1$ MHz

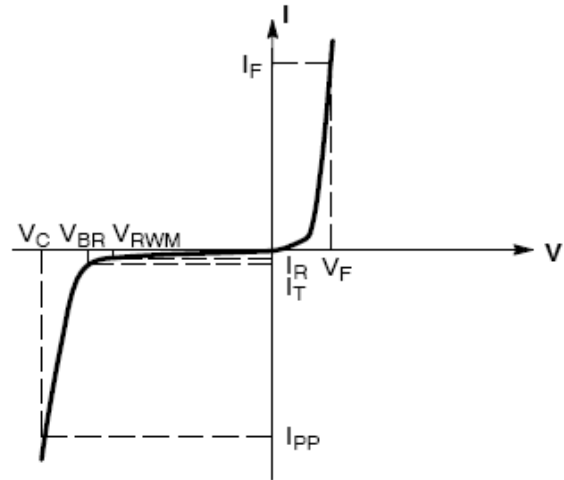

Uni-Directional TVS

ELECTRICAL CHARACTERISTICS ( $T_A=25^\circ\text{C}$  unless otherwise noted,  $V_F=0.9\text{V}$  Max. @  $I_F=10\text{Ma}$  for all types)

Device	$V_{RWM}$ (V)	$I_R$ ( $\mu\text{A}$ ) @ $V_{RWM}$	$V_{BR}$ (V) @ $I_T$ (Note 2)	$I_T$ (mA)	$I_{PP}$ (A) (Note 3)	$V_C$ (V) @ Max $I_{PP}$ (Note 3)	$P_{PK}$ (W) (8*20 $\mu\text{s}$ )	C (pF)
	Max	Max	Min		Max	Max	Max	Typ
LESD11D12T5G	12	1.0	13.3	1.0	4	20	80	15

- $V_{BR}$  is measured with a pulse test current  $I_T$  at an ambient temperature of  $25^\circ\text{C}$
- Surge current waveform per Figure 3.

# LESD11D12T5G

## TYPICAL CHARACTERISTICS

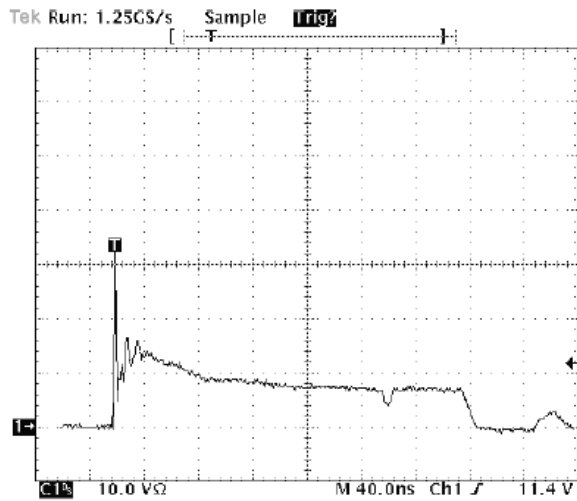

**Figure 1. Positive 8kV contact per IEC 61000-4-2-LESD11D12T5G**

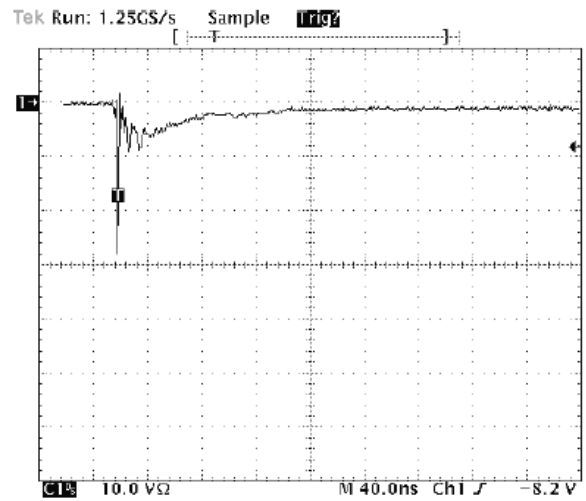

**Fig 2. Negative 8kV contact per IEC 61000-4-2-LESD11D12T5G**

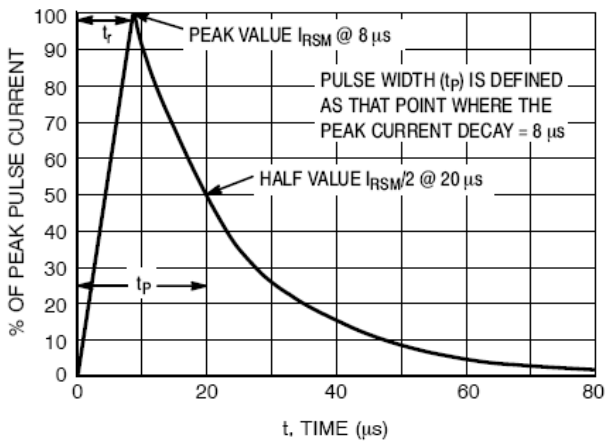

**Figure 3. 8\*20  $\mu$ s Pulse Waveform**

# LESD11D12T5G

## OUTLINE AND DIMENSIONS

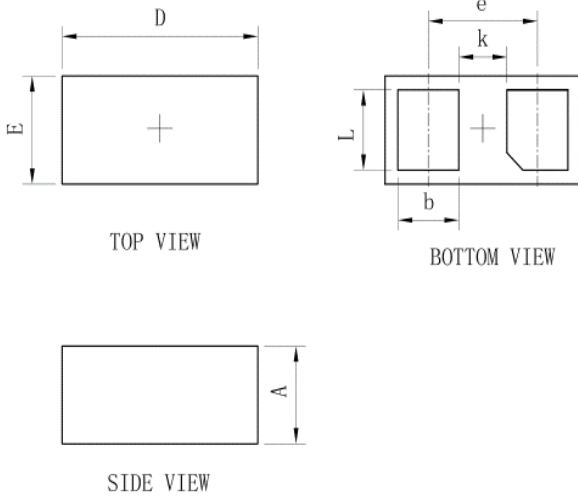

DFN0603-DL			
Dim	Min	Typ.	Max
D	0.58	0.61	0.64
E	0.28	0.31	0.34
e	-	0.34	-
L	0.20	0.23	0.26
b	0.16	0.19	0.22
A	0.25	0.28	0.31
k	0.12	0.15	0.18
All Dimensions in mm			

## SOLDERING FOOTPRINT

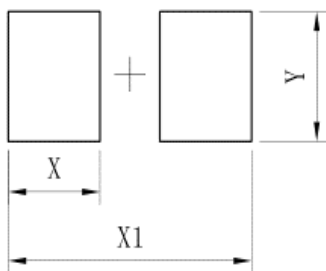

DFN0603-DL	
DIM	(mm)
X	0.23
X1	0.61
Y	0.30

单击下面可查看定价，库存，交付和生命周期等信息

[>>LRC\(乐山无线电\)](#)