

Bias Resistor Transistor

NPN Silicon Surface Mount Transistor with Monolithic Bias Resistor Network

LDTC143XET1G

● **Applications**

Inverter, Interface, Driver

● **Features**

- 1) Built-in bias resistors enable the configuration of an inverter circuit without connecting external input resistors (see equivalent circuit).
- 2) The bias resistors consist of thin-film resistors with complete isolation to allow positive biasing of the input. They also have the advantage of almost completely eliminating parasitic effects.
- 3) Only the on/off conditions need to be set for operation, making the device design easy.

- We declare that the material of product compliance with RoHS requirements.

● **Absolute maximum ratings** (Ta=25°C)

| Parameter | Symbol | Limits | Unit |
|----------------------|------------------|-------------|------|
| Supply voltage | V _{CC} | 50 | V |
| Input voltage | V _{IN} | - 7 to +20 | V |
| Output current | I _C | 100 | mA |
| Power dissipation | P _D | 200 | mW |
| Junction temperature | T _J | 150 | °C |
| Storage temperature | T _{stg} | -55 to +150 | °C |

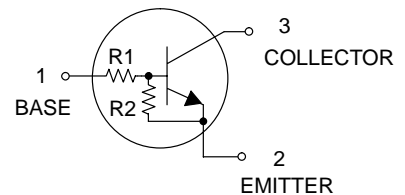
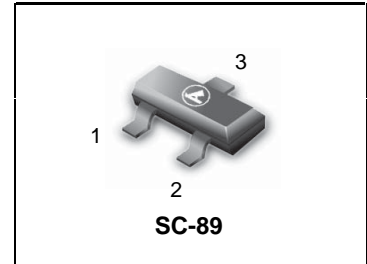

DEVICE MARKING AND RESISTOR VALUES

| Device | Marking | R1 (K) | R2 (K) | Shipping |
|--------------|---------|--------|--------|-------------------|
| LDTC143XET1G | M1 | 4.7 | 10 | 3000/Tape & Reel |
| LDTC143XET3G | M1 | 4.7 | 10 | 10000/Tape & Reel |

● **Electrical characteristics** (Ta=25°C)

| Parameter | Symbol | Min. | Typ. | Max. | Unit | Conditions |
|----------------------|--------------------------------|------|------|------|------|--|
| Input voltage | V _{I(off)} | - | - | 0.3 | V | V _{CC} =5V, I _O =100μA |
| | V _{I(on)} | 2.5 | - | - | | V _O =0.3V, I _O =20mA |
| Output voltage | V _{O(on)} | - | 0.1 | 0.3 | V | I _O /I _I =10mA/0.5mA |
| Input current | I _I | - | - | 1.8 | mA | V _I =5V |
| Output current | I _{O(off)} | - | - | 0.5 | μA | V _{CC} =50V, V _I =0V |
| DC current gain | G _I | 30 | - | - | - | V _O =5V, I _O =10mA |
| Input resistance | R ₁ | 3.29 | 4.7 | 6.11 | kΩ | - |
| Resistance ratio | R ₂ /R ₁ | 1.7 | 2.1 | 2.6 | - | - |
| Transition frequency | f _r * | - | 250 | - | MHz | V _{CE} =10V, I _E =-5mA, f=100MHz |

* Characteristics of built-in transistor

LDTc143XET1G

●Electrical characteristic curves

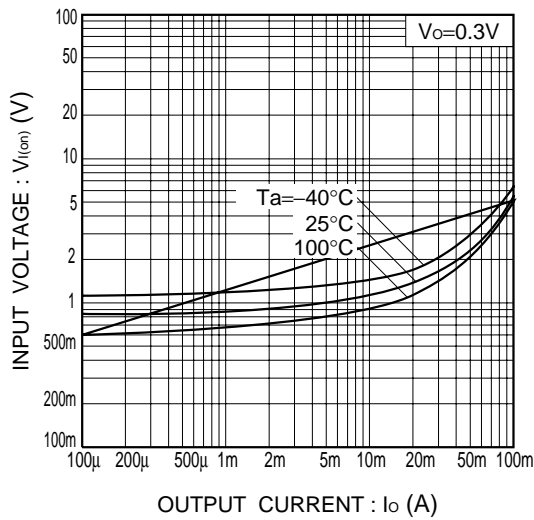

Fig.1 Input voltage vs. output current (ON characteristics)

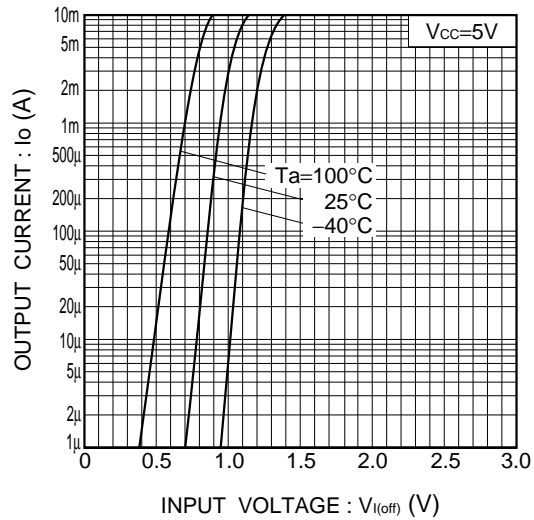

Fig.2 Output current vs. input voltage (OFF characteristics)

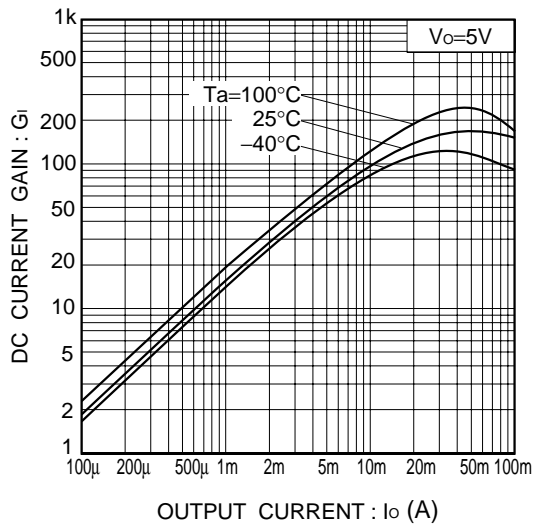

Fig.3 DC current gain vs. output current

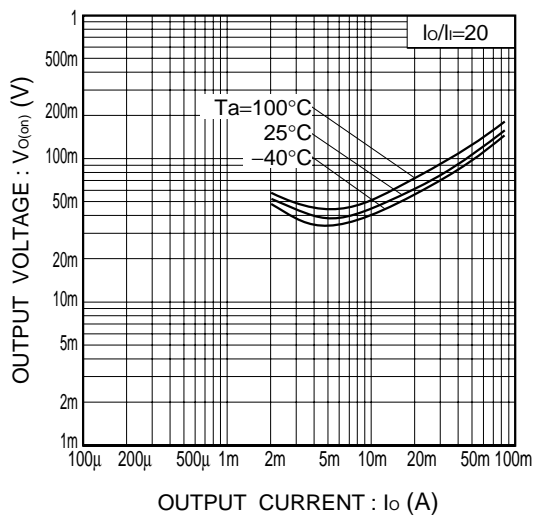
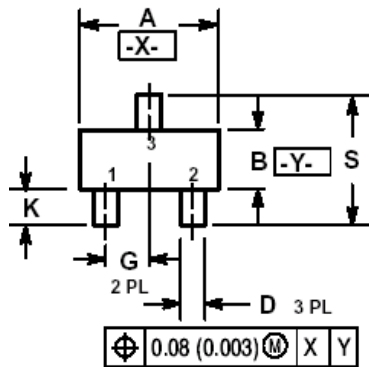

Fig.4 Output voltage vs. output current

LDTC143XET1G

SC-89



NOTES:

1. DIMENSIONING AND TOLERANCING PER ANSI Y14.5M, 1982.
2. CONTROLLING DIMENSION: MILLIMETERS
3. MAXIMUM LEAD THICKNESS INCLUDES LEAD FINISH THICKNESS. MINIMUM LEAD THICKNESS IS THE MINIMUM THICKNESS OF BASE MATERIAL.
4. 463C-01 OBSOLETE, NEW STANDARD 463C-02.

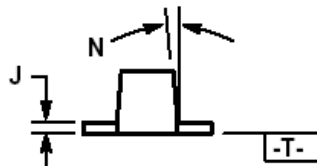
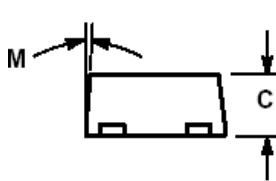

| DIM | MILLIMETERS | | | INCHES | | |
|-----|-------------|------|------|-----------|-------|-------|
| | MIN | NOM | MAX | MIN | NOM | MAX |
| A | 1.50 | 1.60 | 1.70 | 0.059 | 0.063 | 0.067 |
| B | 0.75 | 0.85 | 0.95 | 0.030 | 0.034 | 0.040 |
| C | 0.60 | 0.70 | 0.80 | 0.024 | 0.028 | 0.031 |
| D | 0.23 | 0.28 | 0.33 | 0.009 | 0.011 | 0.013 |
| G | 0.50 BSC | | | 0.020 BSC | | |
| H | 0.53 REF | | | 0.021 REF | | |
| J | 0.10 | 0.15 | 0.20 | 0.004 | 0.006 | 0.008 |
| K | 0.30 | 0.40 | 0.50 | 0.012 | 0.016 | 0.020 |
| L | 1.10 REF | | | 0.043 REF | | |
| M | --- | --- | 10 ° | --- | --- | 10 ° |
| N | --- | --- | 10 ° | --- | --- | 10 ° |
| S | 1.50 | 1.60 | 1.70 | 0.059 | 0.063 | 0.067 |

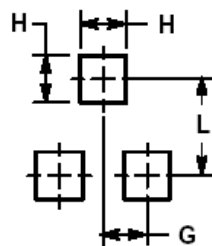

单击下面可查看定价，库存，交付和生命周期等信息

[>>LRC\(乐山无线电\)](#)