

# LBAS40-05LT1G

## S-LBAS40-05LT1G

Schottky barrier diode

### 1. FEATURES

- Low forward current
- Guard ring protected
- Low diode capacitance.
- We declare that the material of product compliance with RoHS requirements and Halogen Free.
- S- prefix for automotive and other applications requiring unique site and control change requirements; AEC-Q101 qualified and PPAP capable.

### 2. APPLICATIONS

- Ultra high-speed switching.
- Voltage clamping.
- Protection circuits.
- Blocking diodes.

### 3. DEVICE MARKING AND RESISTOR VALUES

Device	Marking	Shipping
LBAS40-05LT1G	45	3000/Tape&Reel
S-LBAS40-05LT1G	45	3000/Tape&Reel

### 4. MAXIMUM RATINGS(Ta = 25°C)

Parameter	Symbol	Limits	Unit
Continuous reverse voltage	VR	40	V
Continuous forward current	IF	120	mA
Repetitive Peak forward surge current(tp <1s,δ<0.5)	IFSM	120	mA
Non-repetitive peak forward current (tp <10ms)	IFSM	200	mA
Total Power Dissipation	PD	250	mW
Storage temperature	Tstg	-65~+150	°C
Junction temperature	Tj	150	°C
Operating ambient temperature	Tamb	-65~+150	°C

### 5. THERMAL CHARACTERISTICS

Parameter	Symbol	Limits	Unit
Thermal resistance from junction to ambient (Note 1)	RθJA	500	°C/W

1. Refer to SOT23 or SOT143B standard mounting conditions.

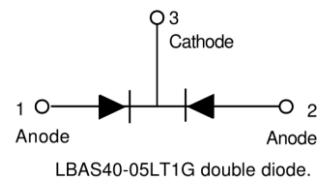
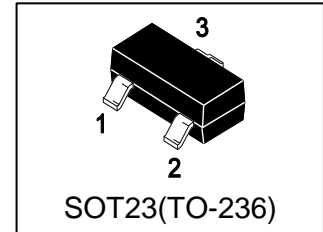

**6. ELECTRICAL CHARACTERISTICS (Ta= 25°C)**

CHARACTERISTICS	Symbol	Limits	Unit
Forward voltage (IF =1mA)	VF	400	mV
(IF =10mA)		560	mV
(IF =40mA)		1	V
Reverse current(Note 2) (VR=30V)	IR	1	μA
(VR=40V)		10	μA
Diode capacitance (f=1MHz,VR =0)	Cd	5	pF

2.Pulse test:tp =300μs,δ=0.02.

**7. ELECTRICAL CHARACTERISTICS CURVES**

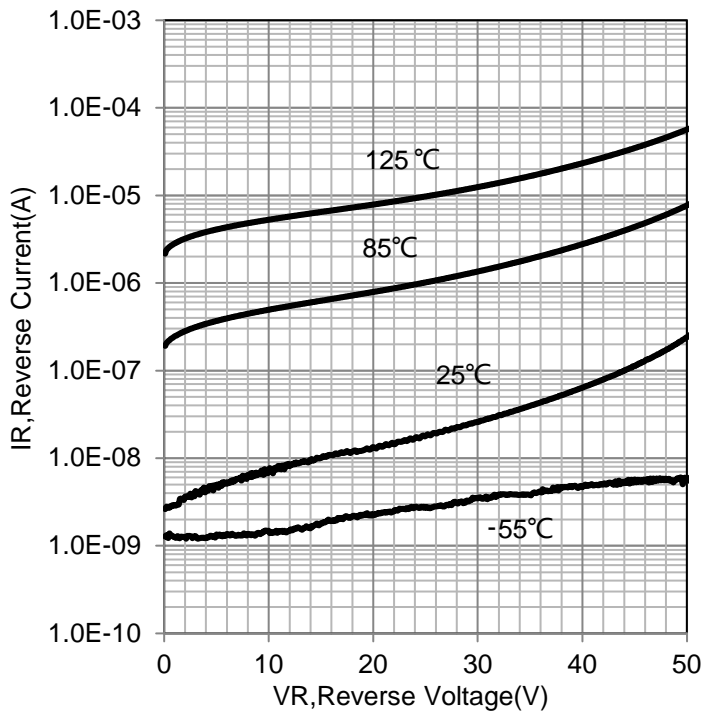

IR vs. VR

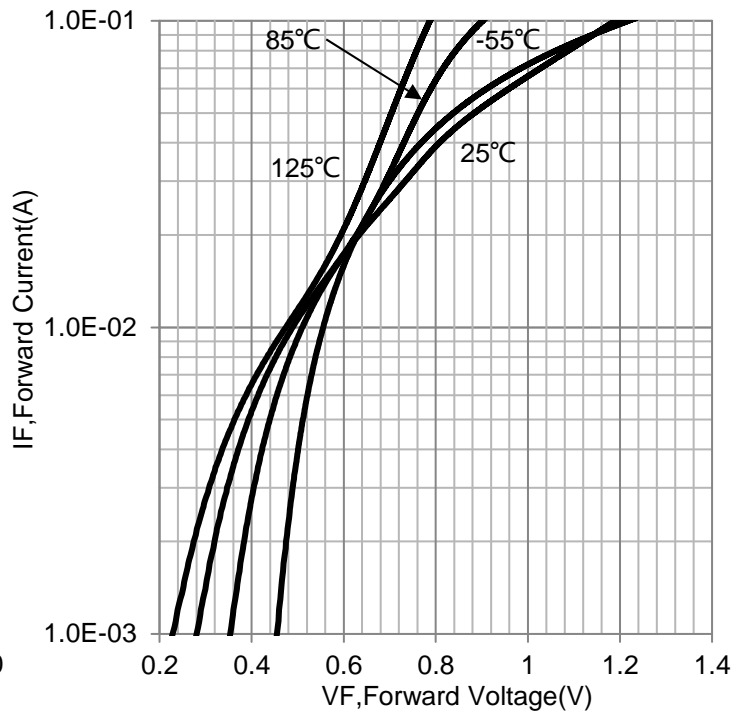

IF vs. VF

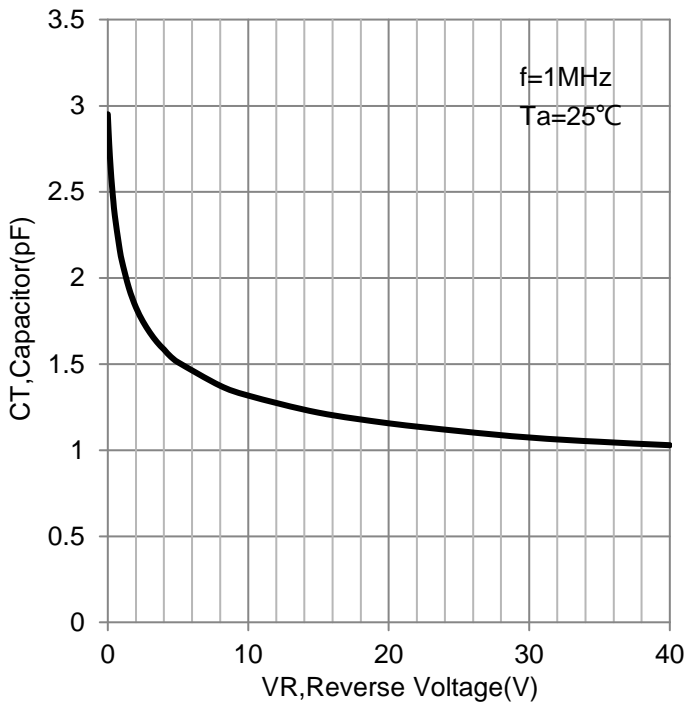

CT vs. VR

### 8. OUTLINE AND DIMENSIONS

Notes:

1. DIMENSIONING AND TOLERANCING PER ANSI Y14.5M, 1982.
2. CONTROLLING DIMENSION: MILLIMETERS.
3. MAXIMUM LEAD THICKNESS INCLUDES LEAD FINISH. MINIMUM LEAD THICKNESS IS THE MINIMUM THICKNESS OF BASE MATERIAL.
4. DIMENSIONS D AND E DO NOT INCLUDE MOLD FLASH, PROTRUSIONS OR GATE BURRS.

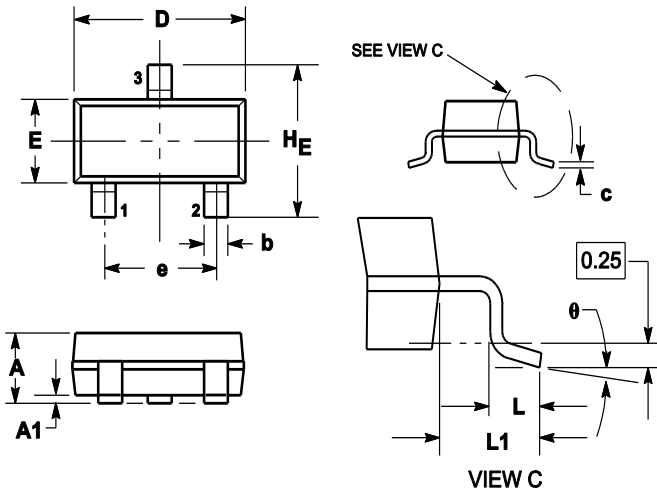

DIM	MILLIMETERS			INCHES		
	MIN	NOM	MAX	MIN	NOM	MAX
A	0.89	1	1.11	0.035	0.04	0.044
A1	0.01	0.06	0.1	0.001	0.002	0.004
b	0.37	0.44	0.5	0.015	0.018	0.02
c	0.09	0.13	0.18	0.003	0.005	0.007
D	2.80	2.9	3.04	0.11	0.114	0.12
E	1.20	1.3	1.4	0.047	0.051	0.055
e	1.78	1.9	2.04	0.07	0.075	0.081
L	0.10	0.2	0.3	0.004	0.008	0.012
L1	0.35	0.54	0.69	0.014	0.021	0.029
H <sub>E</sub>	2.10	2.4	2.64	0.083	0.094	0.104
$\theta$	0°	---	10°	0°	---	10°

### 9. SOLDERING FOOTPRINT

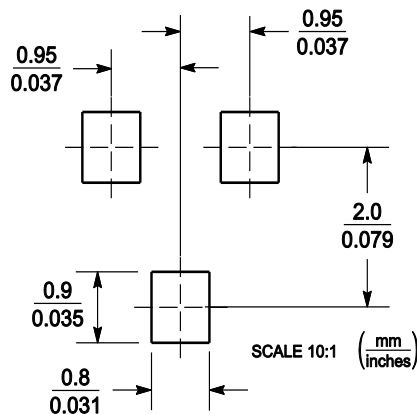

单击下面可查看定价，库存，交付和生命周期等信息

[>>LRC\(乐山无线电\)](#)