

# General Purpose Transistors

## NPN Silicon

- We declare that the material of product compliance with RoHS requirements.
- S- Prefix for Automotive and Other Applications Requiring Unique Site and Control Change Requirements; AEC-Q101 Qualified and PPAP Capable.

L2SC4617QT1G  
Series  
S-L2SC4617QT1G  
Series

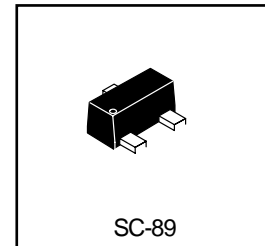

### ORDERING INFORMATION

Device	Marking	Shipping
L2SC4617QT1G S-L2SC4617QT1G	BQ	3000 Tape & Reel
L2SC4617QT3G S-L2SC4617QT3G	BQ	10000 Tape & Reel
L2SC4617RT1G S-L2SC4617RT1G	BR	3000 Tape & Reel
L2SC4617RT3G S-L2SC4617RT3G	BR	10000 Tape & Reel
L2SC4617ST1G S-L2SC4617ST1G	BS	3000 Tape & Reel
L2SC4617ST3G S-L2SC4617ST3G	BS	10000 Tape & Reel

### ●Absolute maximum ratings (Ta=25°C)

Parameter	Symbol	Limits	Unit
Collector-base voltage	V <sub>CB0</sub>	60	V
Collector-emitter voltage	V <sub>CEO</sub>	50	V
Emitter-base voltage	V <sub>EBO</sub>	7	V
Collector current	I <sub>c</sub>	0.15	A
Collector power dissipation	P <sub>c</sub>	0.15	W
Junction temperature	T <sub>j</sub>	150	°C
Storage temperature	T <sub>stg</sub>	-55~+150	°C

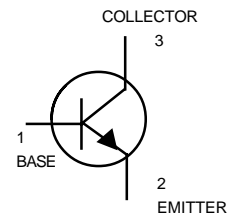

### ●Electrical characteristics (Ta=25°C)

Parameter	Symbol	Min.	Typ.	Max.	Unit	Conditions
Collector-base breakdown voltage	BV <sub>CB0</sub>	60	-	-	V	I <sub>c</sub> =50μA
Collector-emitter breakdown voltage	BV <sub>CEO</sub>	50	-	-	V	I <sub>c</sub> =1mA
Emitter-base breakdown voltage	BV <sub>EBO</sub>	7	-	-	V	I <sub>E</sub> =50μA
Collector cutoff current	I <sub>cBO</sub>	-	-	0.1	μA	V <sub>CB</sub> =60V
Emitter cutoff current	I <sub>EBO</sub>	-	-	0.1	μA	V <sub>EB</sub> =7V
Collector-emitter saturation voltage	V <sub>CE(sat)</sub>	-	-	0.5	V	I <sub>c</sub> /I <sub>B</sub> =50mA/5mA
DC current transfer ratio	h <sub>FE</sub>	120	-	560	-	V <sub>CE</sub> =6V, I <sub>c</sub> =1mA
Transition frequency	f <sub>t</sub>	-	180	-	MHz	V <sub>CE</sub> =12V, I <sub>E</sub> =2mA, f=30MHz
Output capacitance	C <sub>ob</sub>	-	2.0	3.5	pF	V <sub>CB</sub> =12V, I <sub>E</sub> =0A, f=1MHz

### ●Device marking

(S-)L2SC4617QT1G=BQ (S-)L2SC4617RT1G=BR (S-)L2SC4617ST1G=BS

### ●h<sub>FE</sub> values are classified as follows:

Item	Q	R	S
h <sub>FE</sub>	120~270	180~390	270~560

L2SC4617QT1G  
Series  
S-L2SC4617QT1G  
Series

●Electrical characteristic curves

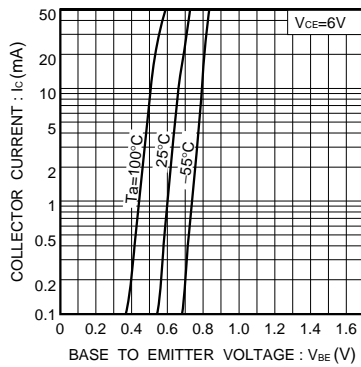

Fig.1 Grounded emitter propagation characteristics

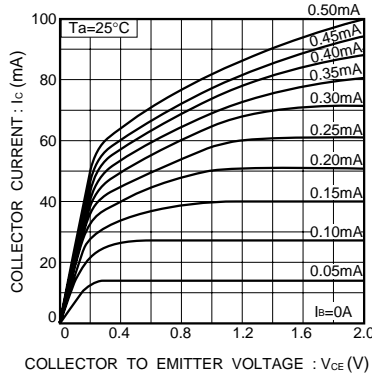

Fig.2 Grounded emitter output characteristics ( I )

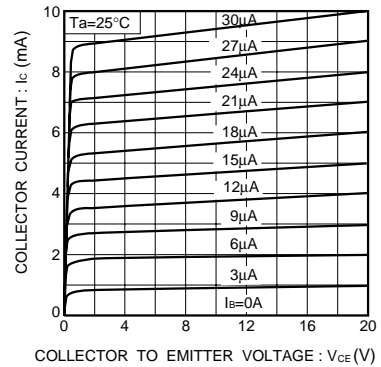

Fig.3 Grounded emitter output characteristics ( II )

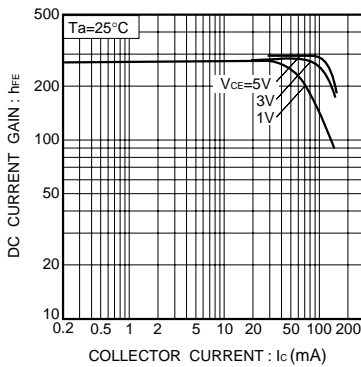

Fig.4 DC current gain vs. collector current ( I )

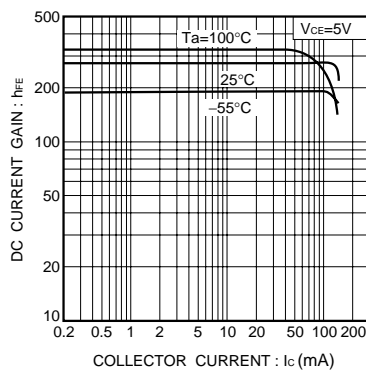

Fig.5 DC current gain vs. collector current ( II )

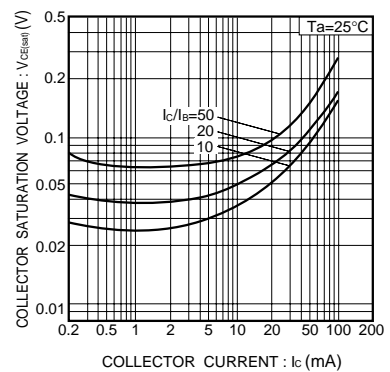

Fig.6 Collector-emitter saturation voltage vs. collector current

L2SC4617QT1G  
Series  
S-L2SC4617QT1G  
Series

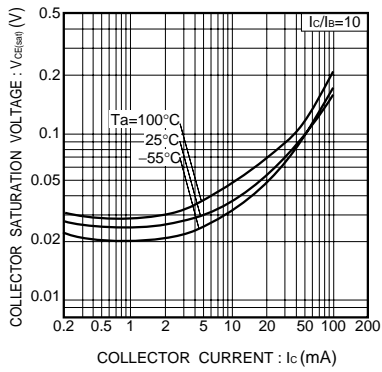

Fig.7 Collector-emitter saturation voltage vs. collector current (I)

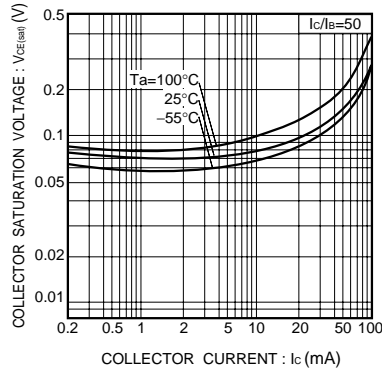

Fig.8 Collector-emitter saturation voltage vs. collector current (II)

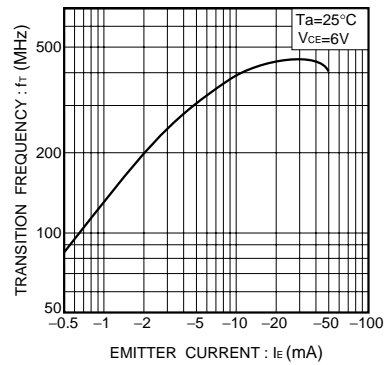

Fig.9 Gain bandwidth product vs. emitter current

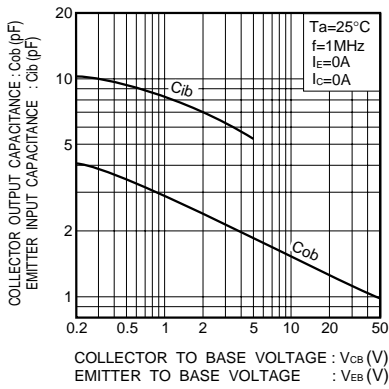

Fig.10 Collector output capacitance vs. collector-base voltage  
Emitter input capacitance vs. emitter-base voltage

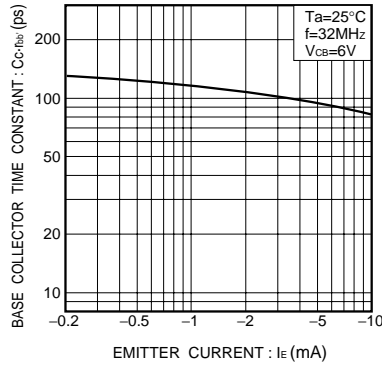
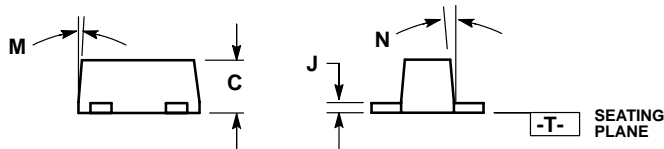
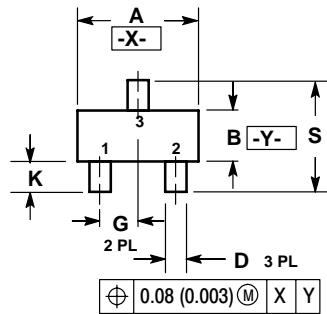

Fig.11 Base-collector time constant vs. emitter current

L2SC4617QT1G  
Series  
S-L2SC4617QT1G  
Series

SC-89



NOTES:

1. DIMENSIONING AND TOLERANCING PER ANSI Y14.5M, 1982.
2. CONTROLLING DIMENSION: MILLIMETERS
3. MAXIMUM LEAD THICKNESS INCLUDES LEAD FINISH THICKNESS. MINIMUM LEAD THICKNESS IS THE MINIMUM THICKNESS OF BASE MATERIAL.
4. 463C-01 OBSOLETE, NEW STANDARD 463C-02.

DIM	MILLIMETERS			INCHES		
	MIN	NOM	MAX	MIN	NOM	MAX
A	1.50	1.60	1.70	0.059	0.063	0.067
B	0.75	0.85	0.95	0.030	0.034	0.040
C	0.60	0.70	0.80	0.024	0.028	0.031
D	0.23	0.28	0.33	0.009	0.011	0.013
G	0.50 BSC			0.020 BSC		
H	0.53 REF			0.021 REF		
J	0.10	0.15	0.20	0.004	0.006	0.008
K	0.30	0.40	0.50	0.012	0.016	0.020
L	1.10 REF			0.043 REF		
M	---	---	10 °	---	---	10 °
N	---	---	10 °	---	---	10 °
S	1.50	1.60	1.70	0.059	0.063	0.067

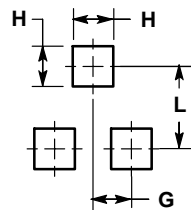

RECOMMENDED PATTERN OF SOLDER PADS

单击下面可查看定价，库存，交付和生命周期等信息

[>>LRC\(乐山无线电\)](#)