

# LBAT54CLT1G

## S-LBAT54CLT1G

Dual Series Schottky Barrier Diode

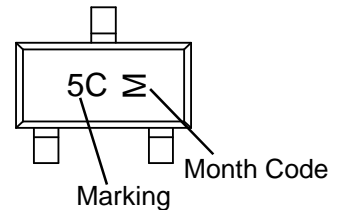
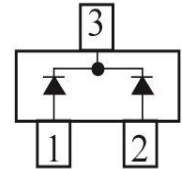
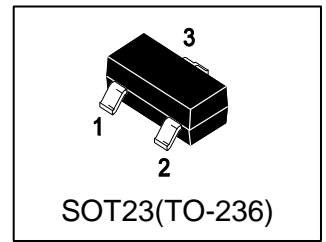

### 1. FEATURES

- We declare that the material of product compliance with RoHS requirements and Halogen Free.
- S- prefix for automotive and other applications requiring unique site and control change requirements; AEC-Q101 qualified and PPAP capable.
- Extremely Fast Switching Speed
- Low Forward Voltage — 0.35 V (Typ) @ IF = 10 mA

### 2. DEVICE MARKING AND ORDERING INFORMATION

Device	Marking	Shipping
LBAT54CLT1G	5C	3000/Tape&Reel
LBAT54CLT3G	5C	10000/Tape&Reel

### 3. MAXIMUM RATINGS(Ta = 25°C)

Parameter	Symbol	Limits	Unit
Reverse Voltage	VR	30	V
Forward Current	IF	200	mA

### 4. THERMAL CHARACTERISTICS

Parameter	Symbol	Limits	Unit
Total Device Dissipation, FR-5 Board (Note 1) @ TA = 25°C Derate above 25°C	PD	225 2.25	mW mW/°C
Thermal Resistance, Junction-to-Ambient(Note 1)	RθJA	445	°C/W
Junction and Storage temperature	TJ,Tstg	-55~+125	°C

1. FR-5 = 1.0×0.75×0.062 in.

**5. ELECTRICAL CHARACTERISTICS (Ta= 25°C)**

Characteristic	Symbol	Min.	Typ.	Max.	Unit
Reverse Breakdown Voltage (IR = 10μA)	VBR	30	-	-	V
Reverse Voltage Leakage Current (VR = 25V)	IR	-	0.5	2	μA
Diode Capacitance (VR = 1.0V , f = 1.0 MHz)	CT	-	-	10	pF
Forward Voltage (IF = 0.1 mA) (IF = 1 mA) (IF = 10 mA) (IF = 30 mA) (IF = 100 mA)	VF	- - - - -	0.22 0.29 0.35 0.41 0.52	0.24 0.32 0.4 0.5 1	V
Reverse Recovery Time (IF = IR = 10 mA, IR(REC) = 1.0 mA)	trr	-	-	5	ns
Repetitive Peak Forward Current	IFRM	-	-	300	mA
Non-Repetitive Peak Forward Current (t < 1.0 s)	IFSM	-	-	600	mA

**6. ELECTRICAL CHARACTERISTICS CURVES**

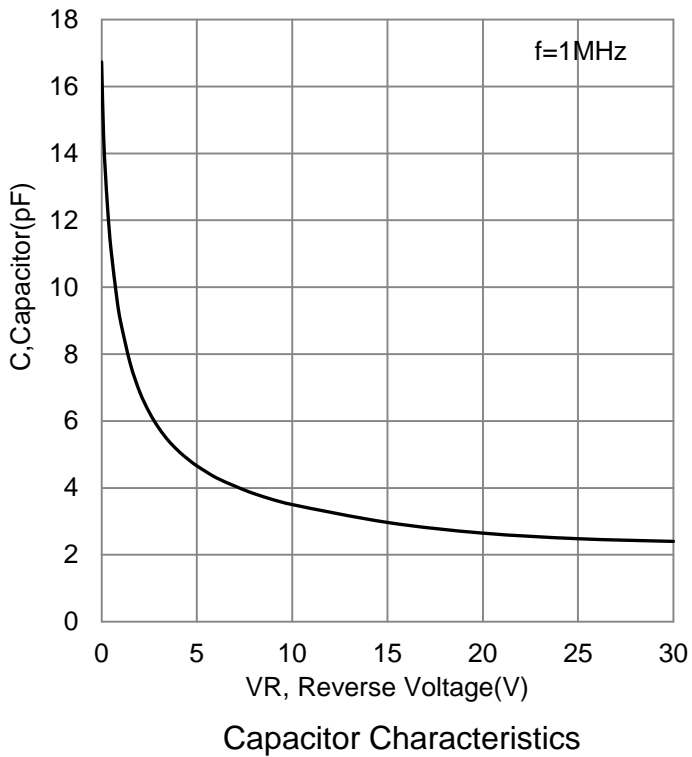
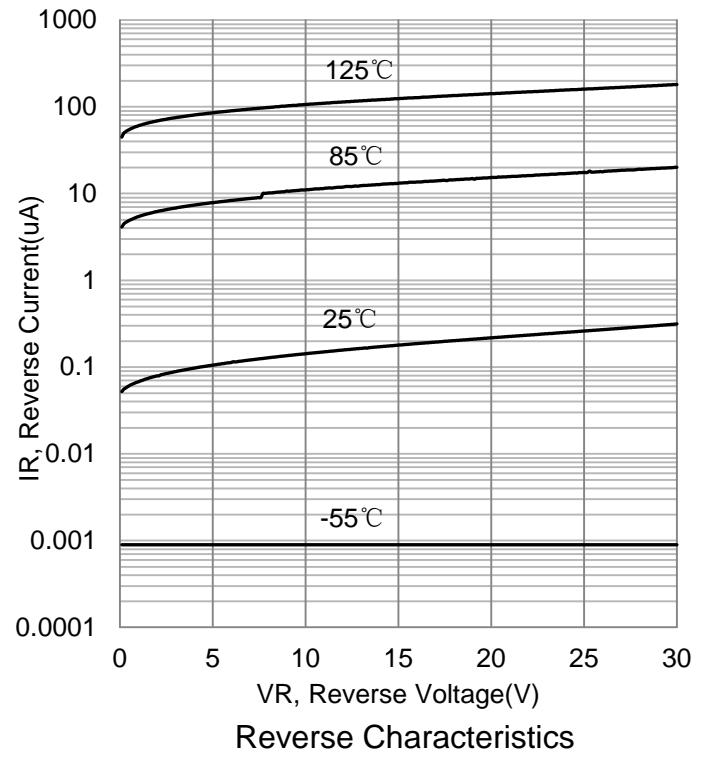
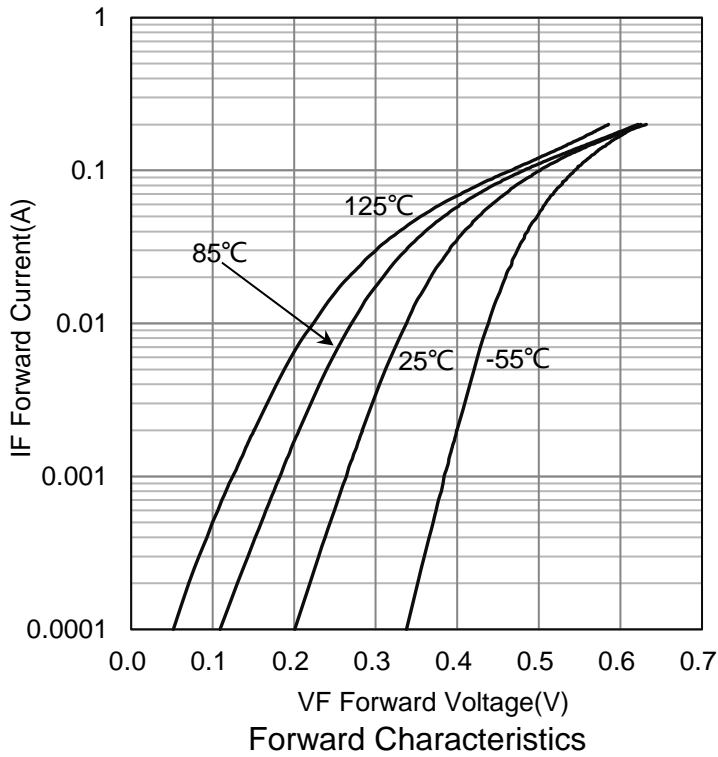

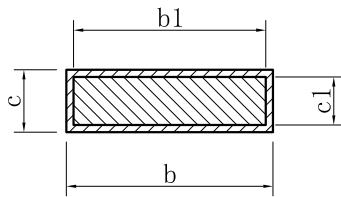
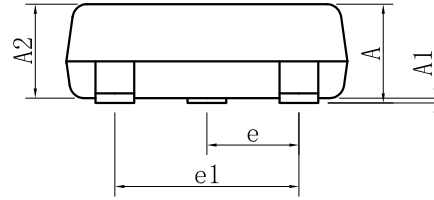
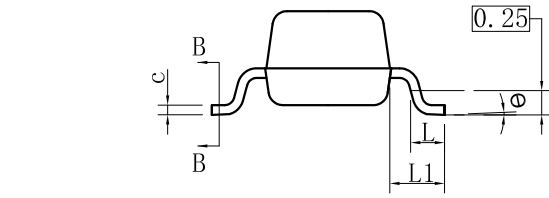
**7. OUTLINE AND DIMENSIONS**

SECTION B-B

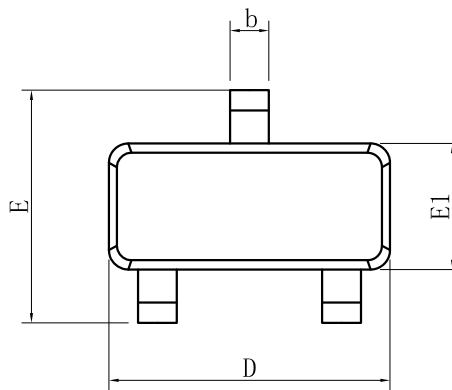

SOT23			
DIM	MIN	NOR	MAX
A	0.89	-	1.12
A1	0.01	-	0.10
A2	0.88	0.95	1.02
b	0.30	-	0.50
b1	0.30	0.40	0.45
c	0.08	-	0.20
c1	0.08	0.10	0.16
D	2.80	2.90	3.04
E	2.10	-	2.64
E1	1.20	1.30	1.40
e	0.95BSC		
e1	1.90BSC		
L	0.40	0.46	0.60
L1	0.54REF		
θ	0°	-	8°
All Dimensions in mm			

**GENERAL NOTES**

1. Top package surface finish  $Ra0.4 \pm 0.2\mu m$
2. Bottom package surface finish  $Ra0.7 \pm 0.2\mu m$
3. Side package surface finish  $Ra0.4 \pm 0.2\mu m$

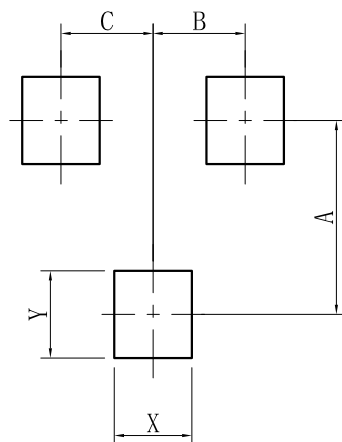
**8. SOLDERING FOOTPRINT**

SOT-23	
DIM	(mm)
X	0.80
Y	0.90
A	2.00
B	0.95
C	0.95

## **DISCLAIMER**

- Curve guarantee in the specification. The curve of test items with electric parameter is used as quality guarantee. The curve of test items without electric parameter is used as reference only.
- Before you use our Products for new Project, you are requested to carefully read this document and fully understand its contents. LRC shall not be in any way responsible or liable for failure, malfunction or accident arising from the use of any LRC's Products against warning, caution or note contained in this document.
- All information contained in this document is current as of the issuing date and subject to change without any prior notice. Before purchasing or using LRC's Products, please confirm the latest information with a LRC sales representative.

单击下面可查看定价，库存，交付和生命周期等信息

[>>LRC\(乐山无线电\)](#)