

Silicon Hot-Carrier Diodes

Schottky Barrier Diodes

These devices are designed primarily for high-efficiency UHF and VHF detector applications. They are readily adaptable to many other fast switching RF and digital applications. They are supplied in an inexpensive plastic package for low-cost, high-volume consumer and industrial/commercial requirements. They are also available in a Surface Mount package.

- Extremely Low Minority Carrier Lifetime –15ps(Typ)
- Very Low Capacitance –1.5pF(Max)@ $V_R=15V$
- Low Reverse Leakage – $I_R=13$ nAdc(Typ) LMBD301
- We declare that the material of product compliance with RoHS requirements.
- S- Prefix for Automotive and Other Applications Requiring Unique Site and Control Change Requirements; AEC-Q101 Qualified and PPAP Capable.

LMBD301LT1G
S-LMBD301LT1G

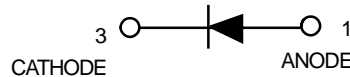
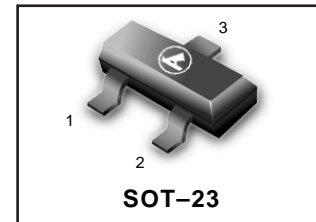

MAXIMUM RATINGS($T_J=125^{\circ}C$ unless otherwise noted)

Rating	symbol	value	unit
Reverse Voltage	V_R	30	Volts
Forward Power Dissipation	P_F	280	200
@ $T_A=25^{\circ}C$			mW
Derate above $25^{\circ}C$		2.8	2.0
			mW/ $^{\circ}C$
Operating Junction	T_J		$^{\circ}C$
Temperature Range		-55 to +125	
Storage Temperature Range	T_{stg}	-55 to +150	$^{\circ}C$

DEVICE MARKING

LMBD301LT1G= 4T

ELECTRICAL CHARACTERISTICS($T_A=25^{\circ}C$ unless otherwise noted)

Characteristic	Symbol	Min	Typ	Max	Unit
Reverse Breakdown Voltage($I_R=10\mu A$)	$V_{(BR)R}$	30	—	—	Volts
Total Capacitance($V_R=15V, f=1.0MHz$), Figure1	C_T	—	0.9	1.5	pF
Reverse Leakage($V_R=25V$) Figure3	I_R	—	13	200	nAdc
Forward Voltage($I_F=1.0mAdc$) Figure4	V_F	—	0.38	0.45	Vdc
Forward Voltage($I_F=10mAdc$) Figure4	V_F	—	0.52	0.6	Vdc

NOTE: LMBD301LT1G is also available in bulk packaging. Use **LMBD301LT1G** as the device title to order this device in bulk.

Ordering Information

Device	Marking	Shipping
LMBD301LT1G S-LMBD301LT1G	4T	3000/Tape&Reel
LMBD301LT3G S-LMBD301LT3G	4T	10000/Tape&Reel

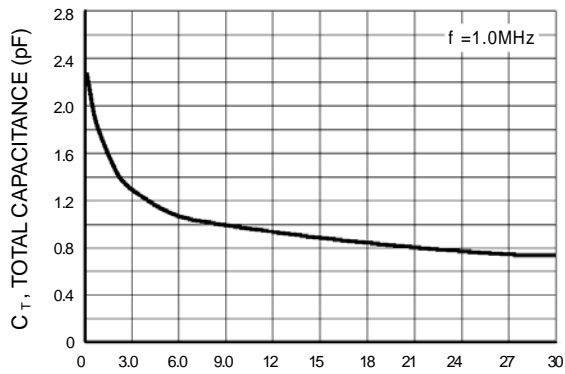
LMBD301LT1G , S-LMBD301LT1G
TYPICAL ELECTRICAL CHARACTERISTICS

V_R , REVERSE VOLTAGE (VOLTS)
Figure 1. Total Capacitance

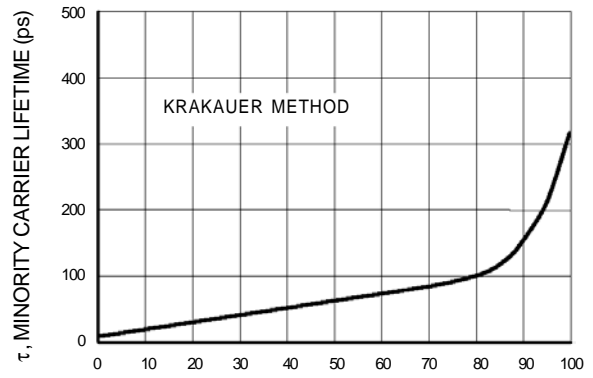

I_F , FORWARD CURRENT (mA)
Figure 2. Minority Carrier Lifetime

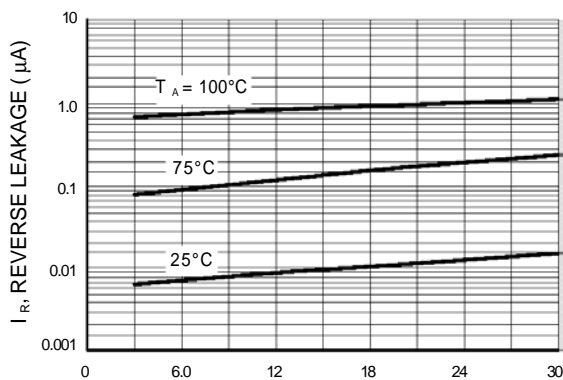

V_R , REVERSE VOLTAGE (VOLTS)
Figure 3. Reverse Leakage

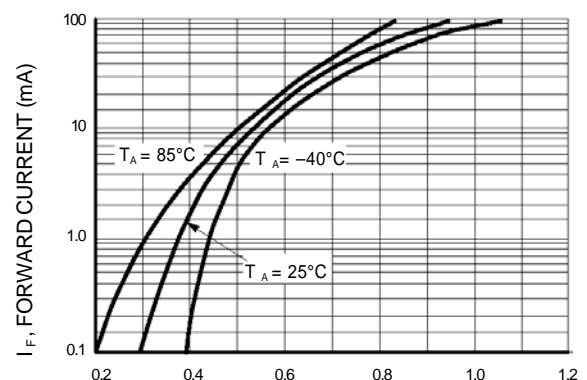

V_F , FORWARD VOLTAGE (VOLTS)
Figure 4. Forward Voltage

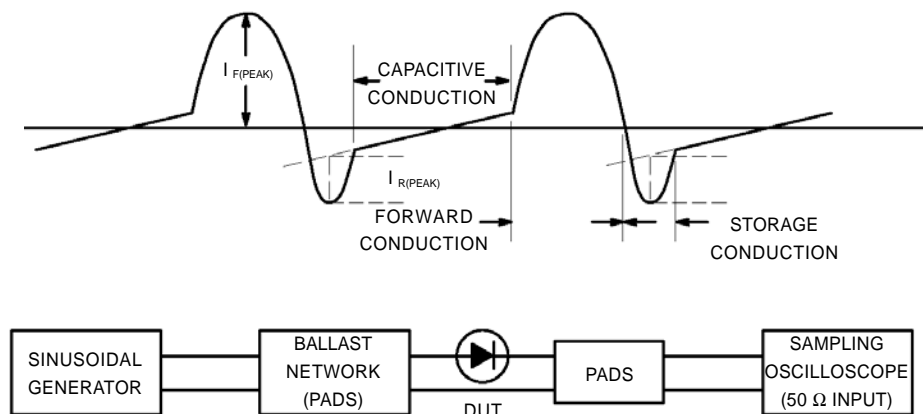
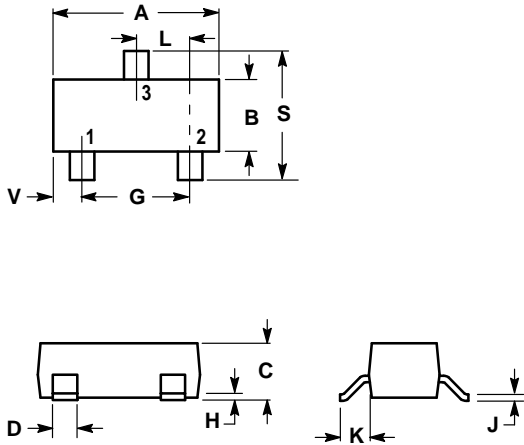

Figure 5. Krakauer Method of Measuring Lifetime

LMBD301LT1G , S-LMBD301LT1G

SOT-23



NOTES:

1. DIMENSIONING AND TOLERANCING PER ANSI Y14.5M, 1982.
2. CONTROLLING DIMENSION: INCH.

DIM	INCHES		MILLIMETERS	
	MIN	MAX	MIN	MAX
A	0.1102	0.1197	2.80	3.04
B	0.0472	0.0551	1.20	1.40
C	0.0350	0.0440	0.89	1.11
D	0.0150	0.0200	0.37	0.50
G	0.0701	0.0807	1.78	2.04
H	0.0005	0.0040	0.013	0.100
J	0.0034	0.0070	0.085	0.177
K	0.0140	0.0285	0.35	0.69
L	0.0350	0.0401	0.89	1.02
S	0.0830	0.1039	2.10	2.64
V	0.0177	0.0236	0.45	0.60

- PIN 1. ANODE
 2. NO CONNECTION
 3. CATHODE

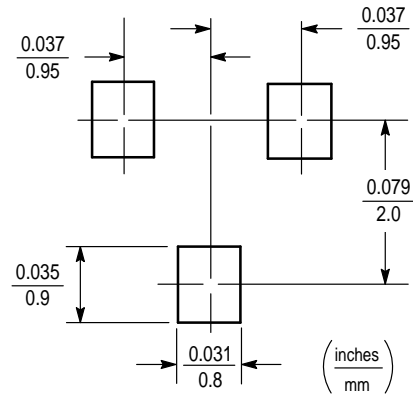

单击下面可查看定价，库存，交付和生命周期等信息

[>>LRC\(乐山无线电\)](#)