

LBAS16LT1G

S-LBAS16LT1G

Switching Diode

1. FEATURES

- We declare that the material of product compliance with RoHS requirements and Halogen Free.
- S- prefix for automotive and other applications requiring unique site and control change requirements; AEC-Q101 qualified and PPAP capable.

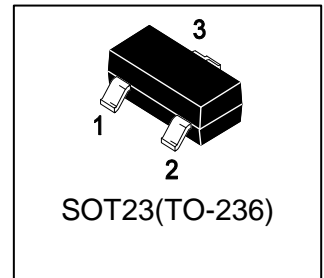

2. DEVICE MARKING AND RESISTOR VALUES

Device	Marking	Shipping
LBAS16LT1G	A6	3000/Tape&Reel
LBAS16LT3G	A6	10000/Tape&Reel

3. MAXIMUM RATINGS(Ta = 25°C)

Parameter	Symbol	Limits	Unit
Continuous Reverse Voltage	VR	75	V
Peak Forward Current	IF	200	mA
Peak Forward Surge Current	IFSM	500	mA

4. THERMAL CHARACTERISTICS

Parameter	Symbol	Limits	Unit
Total Device Dissipation FR-5 Board, (Note 1) TA = 25°C	PD	225	mW
Derate above 25°C		1.8	mW/°C
Thermal Resistance, Junction to Ambient	RθJA	556	°C/W
Total Device Dissipation Alumina Substrate, (Note 2) TA = 25°C	PD	300	mW
Derate above 25°C		2.4	mW/°C
Thermal Resistance, Junction to Ambient	RθJA	417	°C/W
Junction and Storage Temperature	TJ , Tstg	-55~+150	°C

1. FR-5 = 1.0 x 0.75 x 0.062 in.

2. Alumina = 0.4 x 0.3 x 0.024 in. 99.5% alumina.

5. ELECTRICAL CHARACTERISTICS (Ta= 25°C)

CHARACTERISTICS	Symbol	Min	Max	Unit
Reverse Voltage Leakage Current (VR=75V) (VR=75V, TJ = 150°C) (VR=25V, TJ = 150°C)	IR	- - -	1 50 30	μA
Reverse Breakdown Voltage (IBR = 100 μA)	VBR	75	-	V
Forward voltage (IF =1mA) (IF =10mA) (IF =50mA) (IF =150mA)	VF	- - - -	715 855 1000 1250	mV
Diode capacitance (f=1MHz, VR =0)	Cd	-	2	pF
Forward Recovery Voltage (IF = 10 mA, tr = 20ns)	VFR	-	1.75	V
Reverse Recovery Time (IF = IR = 10mA, RL = 50 Ω)	Trr	-	6	nS
Stored Charge (IF = 10 mA to VR = 5.0V, RL = 500 Ω)	QS	-	45	pC

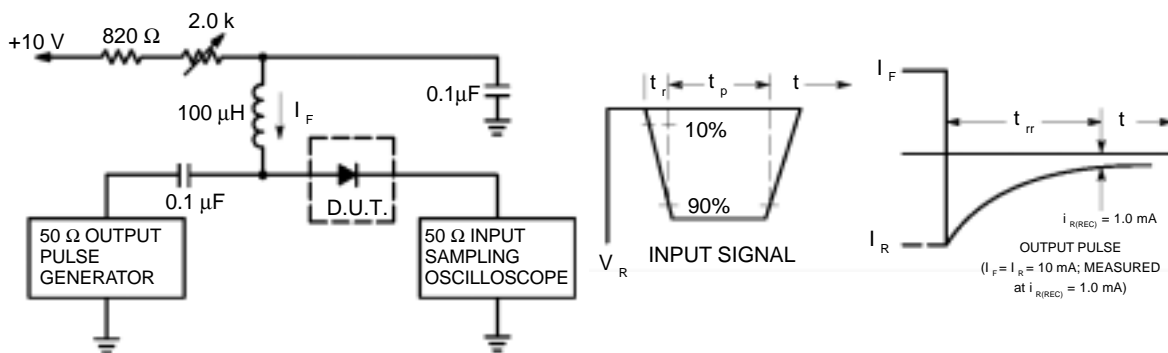

- Notes: 1. A 2.0 kΩ variable resistor adjusted for a Forward Current (I_F) of 10 mA.
 2. Input pulse is adjusted so $I_{R(\text{peak})}$ is equal to 10 mA.
 3. $t_p \gg t_{rr}$

Figure 1. Recovery Time Equivalent Test Circuit

6.ELECTRICAL CHARACTERISTICS CURVES

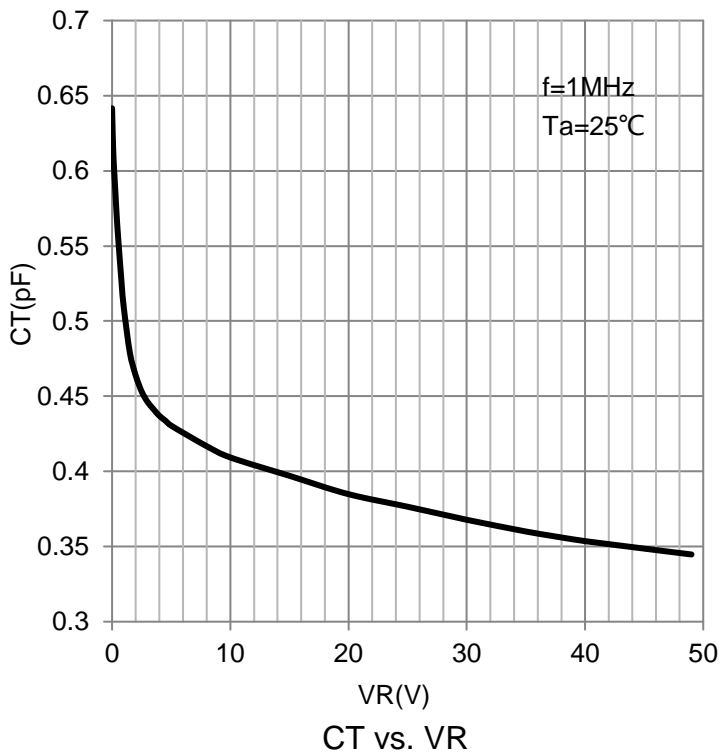
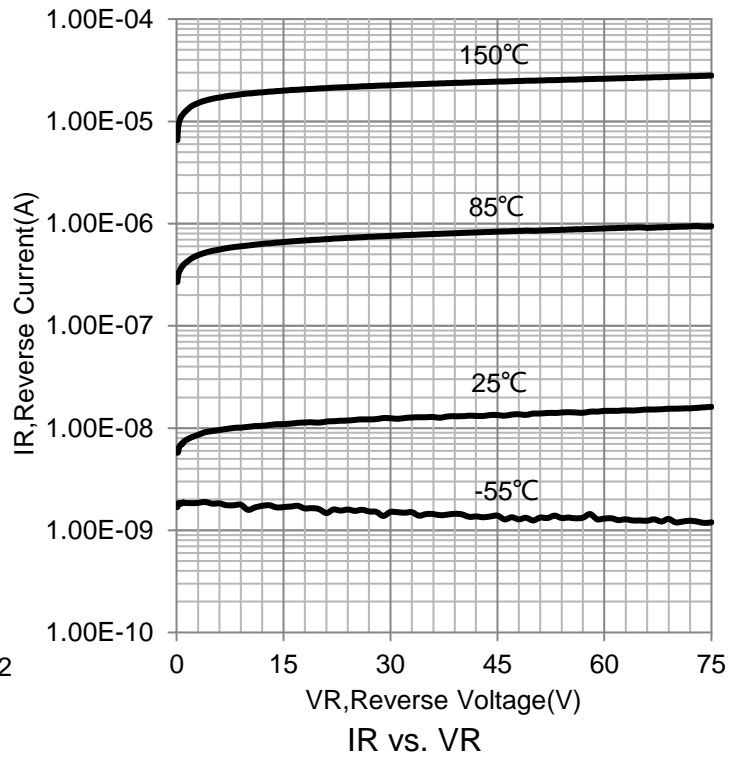
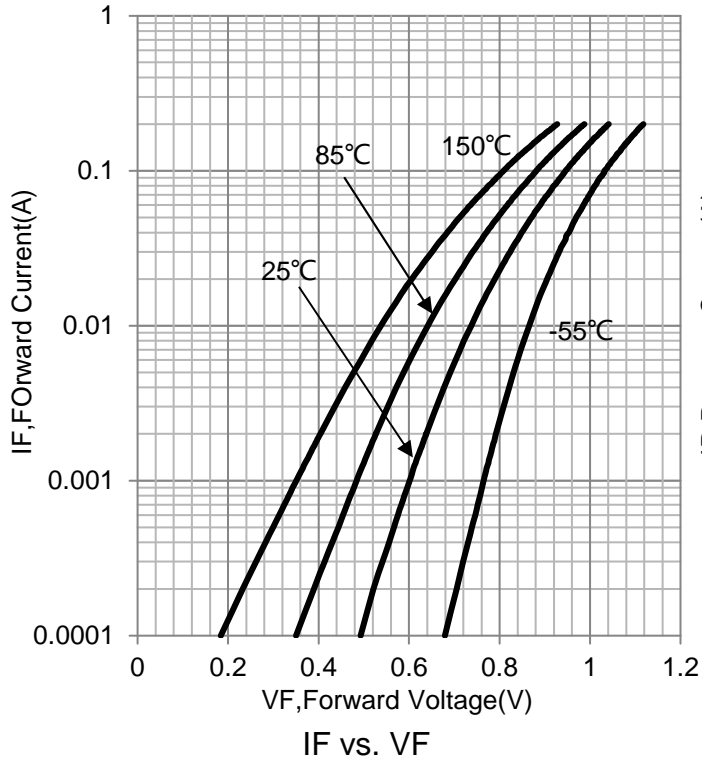

7. OUTLINE AND DIMENSIONS

Notes:

1. DIMENSIONING AND TOLERANCING PER ANSI Y14.5M, 1982.
2. CONTROLLING DIMENSION: MILLIMETERS.
3. MAXIMUM LEAD THICKNESS INCLUDES LEAD FINISH. MINIMUM LEAD THICKNESS IS THE MINIMUM THICKNESS OF BASE MATERIAL.
4. DIMENSIONS D AND E DO NOT INCLUDE MOLD FLASH, PROTRUSIONS OR GATE BURRS.

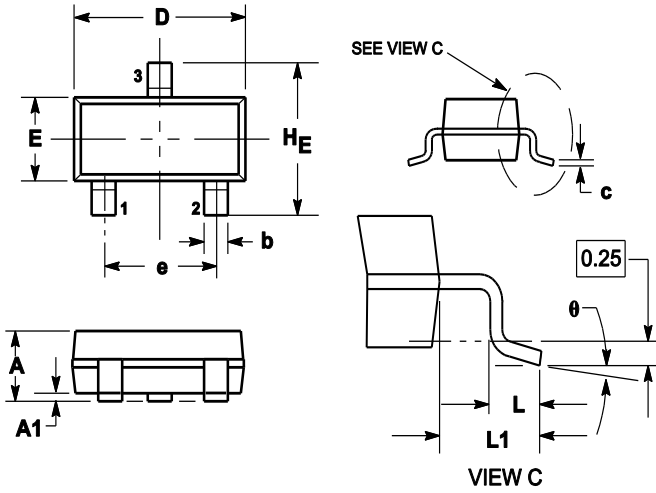

DIM	MILLIMETERS			INCHES		
	MIN	NOM	MAX	MIN	NOM	MAX
A	0.89	1	1.11	0.035	0.04	0.044
A1	0.01	0.06	0.1	0.001	0.002	0.004
b	0.37	0.44	0.5	0.015	0.018	0.02
c	0.09	0.13	0.18	0.003	0.005	0.007
D	2.80	2.9	3.04	0.11	0.114	0.12
E	1.20	1.3	1.4	0.047	0.051	0.055
e	1.78	1.9	2.04	0.07	0.075	0.081
L	0.10	0.2	0.3	0.004	0.008	0.012
L1	0.35	0.54	0.69	0.014	0.021	0.029
HE	2.10	2.4	2.64	0.083	0.094	0.104
theta	0°	---	10°	0°	---	10°

8. SOLDERING FOOTPRINT

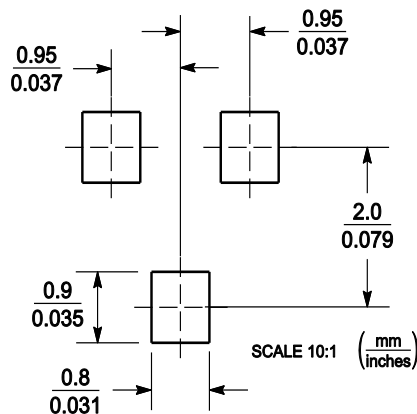

单击下面可查看定价，库存，交付和生命周期等信息

[>>LRC\(乐山无线电\)](#)

[>>点击查看相关商品](#)