

S-LN06N060TZHG

60V N-Channel (D-S) MOSFET

1. FEATURES

- Low thermal impedance.
- Fast switching speed.
- We declare that the material of product compliance with RoHS requirements and Halogen Free.
- S- prefix for automotive and other applications requiring unique site and control change requirements; AEC-Q101 qualified and PPAP capable.

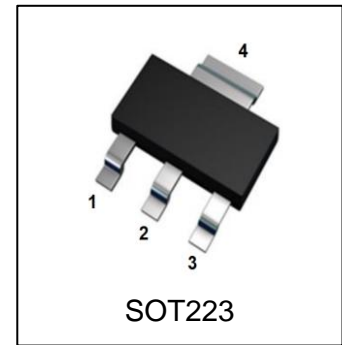

2. APPLICATIONS

- Load/Power switch for portables and computing
- DC-DC conversion

3. DEVICE MARKING AND ORDERING INFORMATION

| Device | Marking | Shipping |
|----------------|---------|----------------|
| S-LN06N060TZHG | GS | 1000/Tape&Reel |

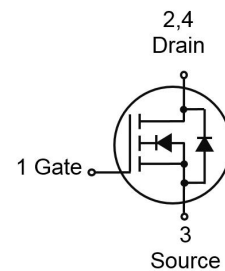

4. MAXIMUM RATINGS(Ta = 25°C)

| Parameter | Symbol | Limits | Unit |
|--|-----------|----------|------|
| Drain-Source Voltage | VDS | 60 | V |
| Gate-Source Voltage | VGS | ± 20 | |
| Continuous Drain Current (Note 1) | ID | 4.5 | A |
| Pulsed Drain Current (Note 2) | IDM | 18 | |
| Avalanche Current (L = 0.1mH) | IAS | 12 | A |
| Avalanche Energy (L = 0.1mH) | EAS | 7.2 | mJ |
| Power Dissipation (Note 1) | PD | 2 | W |
| Operating Junction and Storage Temperature Range | TJ , Tstg | -55~+150 | °C |

5. THERMAL CHARACTERISTICS

| Parameter | Symbol | Limits | Unit |
|--|--------|--------|------|
| Thermal Resistance,Junction-to-Ambient(Note 1) | RθJA | 60 | °C/W |
| Thermal Resistance,Junction-to-Case | RθJC | 10 | °C/W |

1."1.5 x 1.5" FR4 board using 1 sq in pad, 2 oz Cu.

2.Pulse width limited by maximum junction temperature

6. ELECTRICAL CHARACTERISTICS (Ta= 25°C)

| Characteristic | Symbol | Min. | Typ. | Max. | Unit | |
|---|--|---------|------|----------|------|----|
| Static | | | | | | |
| Drain-Source Breakdown Voltage (VGS = 0 V, ID = 250 μA) | VBRDSS | 60 | - | - | V | |
| Gate-Source Threshold Voltage (VDS = VGS, ID = 250 μA) | VGS(th) | 1.0 | 2.0 | 3.0 | V | |
| Gate-Body Leakage Current (VDS = 0 V, VGS = ± 20 V) | IGSS | - | - | ± 100 | nA | |
| Zero Gate Voltage Drain Current (VDS = 60 V, VGS = 0 V) | IDSS | - | - | 1 | uA | |
| Drain-Source On-Resistance(Note 3) (VGS = 10 V, ID = 3 A) (VGS = 5 V, ID = 2 A) | RDS(ON) | - | - | 60 75 | mΩ | |
| Diode Forward Voltage (IS = 1 A, VGS = 0 V) | VSD | - | - | 1.2 | V | |
| Dynamic | | | | | | |
| Total Gate Charge | (VDS = 30 V, ID = 3 A, VGS = 10 V) | Qg | - | 12.7 | - | nC |
| Gate-Source Charge | | Qgs | - | 2.3 | - | |
| Gate-Drain Charge | | Qgd | - | 3.6 | - | |
| Input Capacitance | (VGS = 0 V, VDS = 30 V, f= 1MHz) | Ciss | - | 743 | - | pF |
| Output Capacitance | | Coss | - | 38 | - | |
| Reverse Transfer Capacitance | | Crss | - | 26 | - | |
| Turn-On Delay Time | (VDS = 30 V, RL = 30 Ω, ID = 1 A, VGS = 10 V, RG = 6.2 Ω) | td(on) | - | 8.1 | - | ns |
| Rise Time | | tr | - | 4.2 | - | |
| Turn-Off Delay Time | | td(off) | - | 26.4 | - | |
| Fall Time | | tf | - | 5.2 | - | |

3.Pulse test: PW ≤ 300us duty cycle ≤ 2%.

7. ELECTRICAL CHARACTERISTICS CURVES

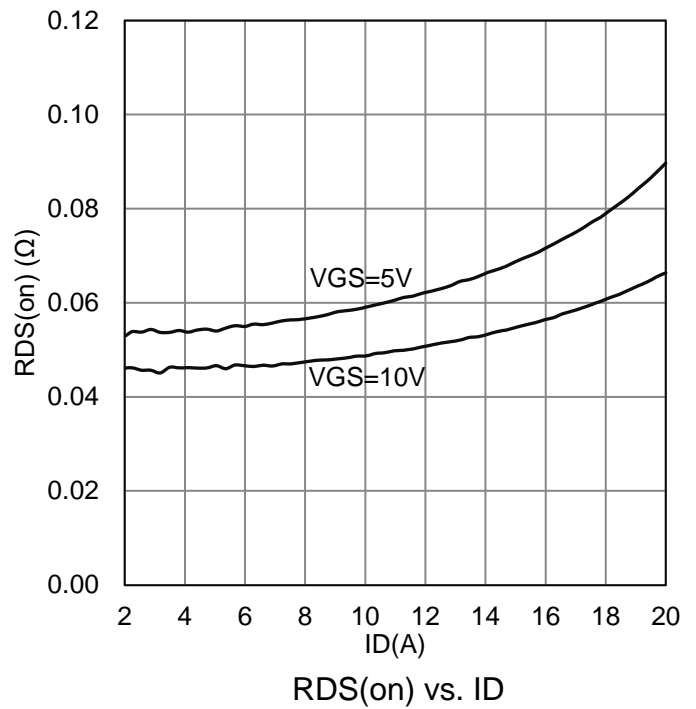
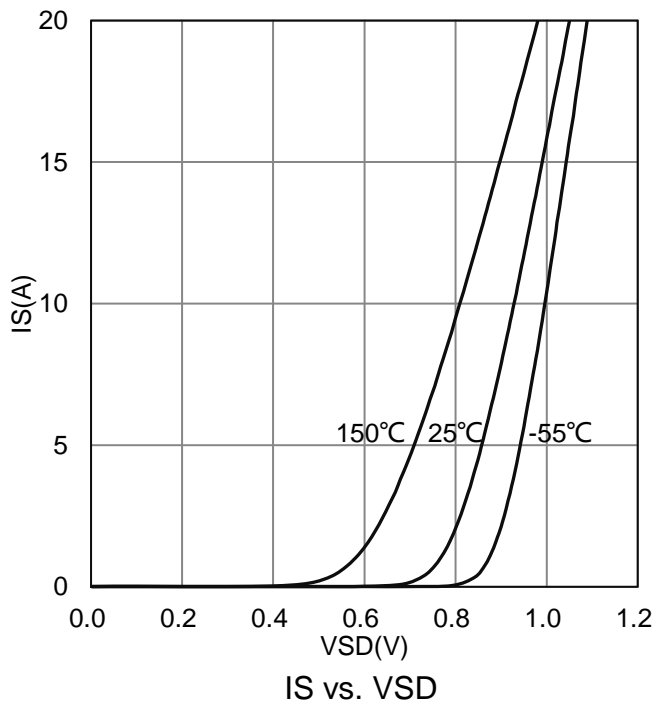
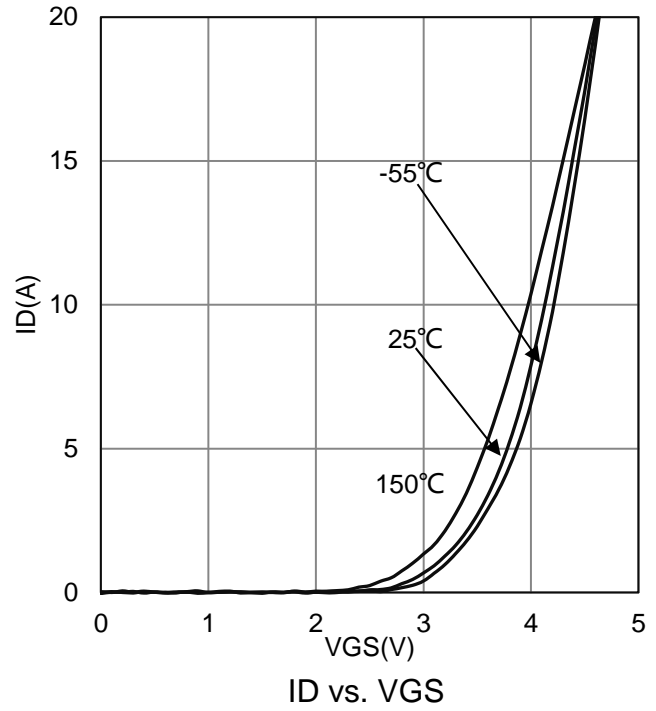
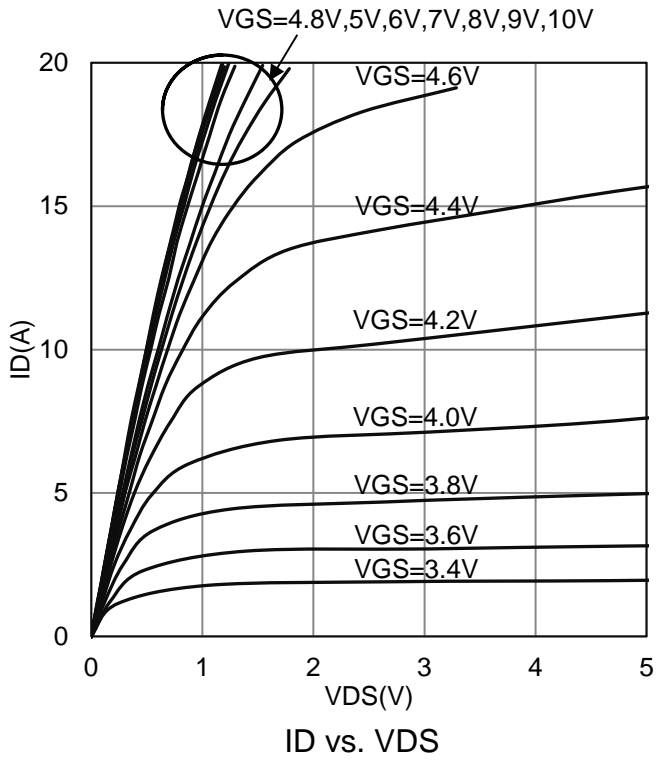

7. ELECTRICAL CHARACTERISTICS CURVES(Con.)

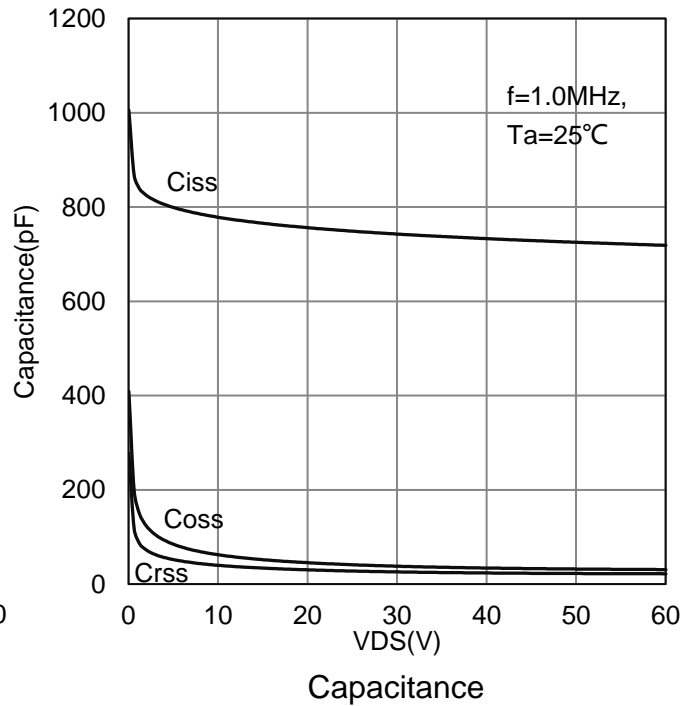
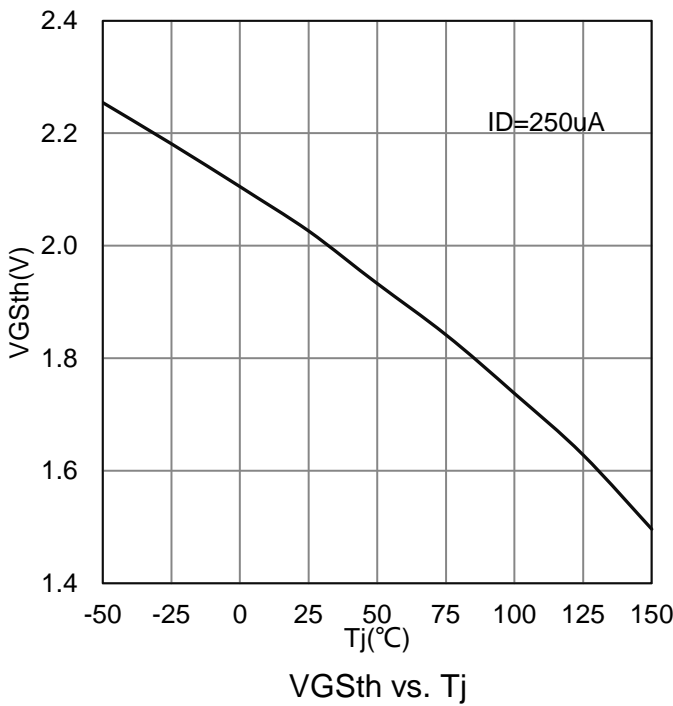
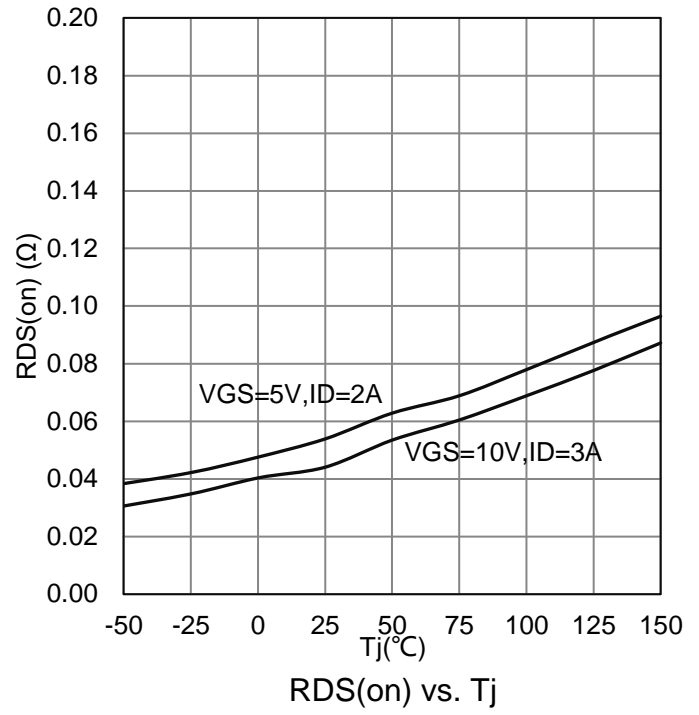
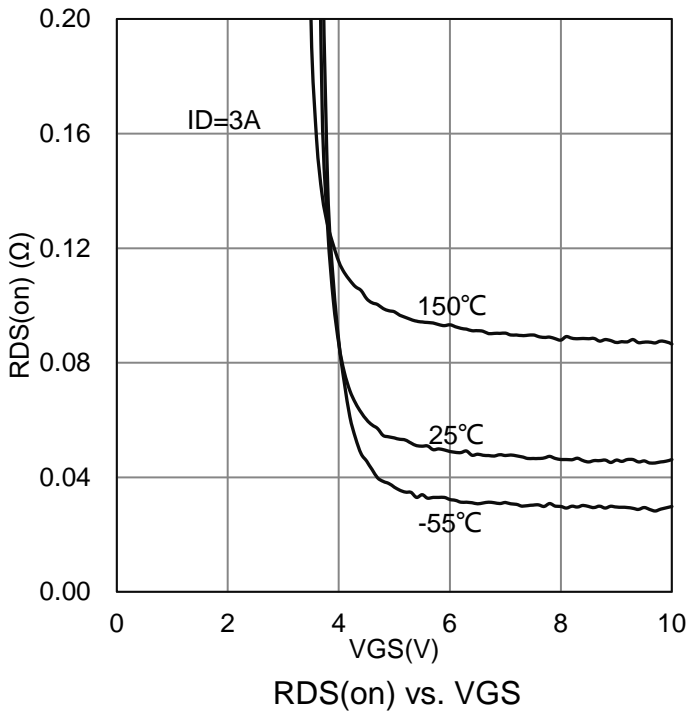

7. ELECTRICAL CHARACTERISTICS CURVES(Con.)

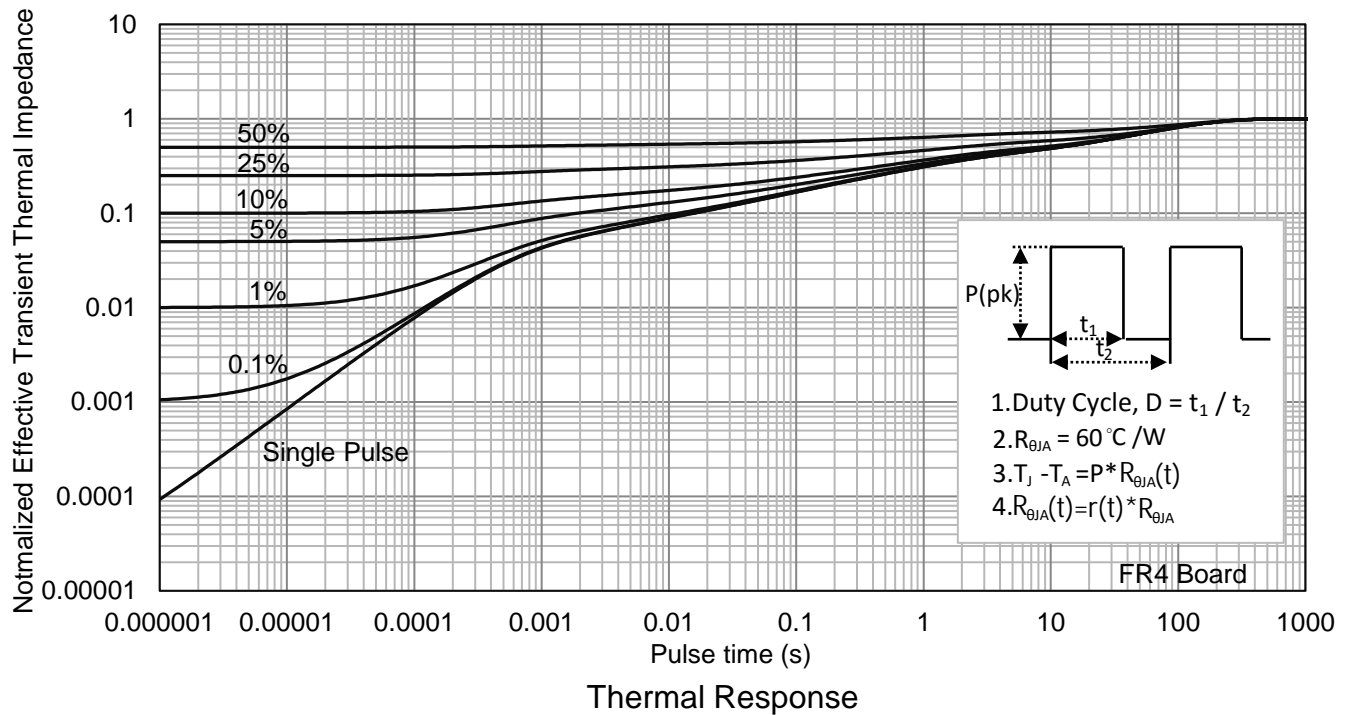
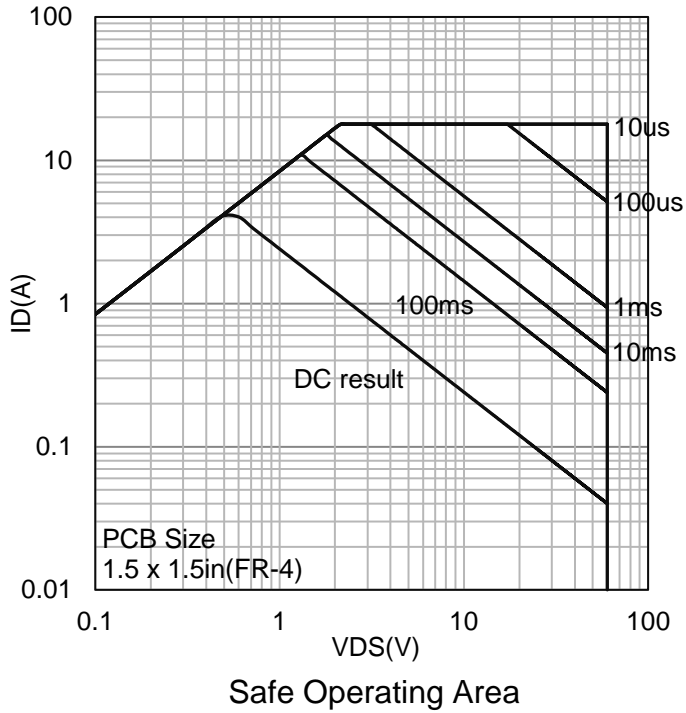

8.OUTLINE AND DIMENSIONS

SOT223

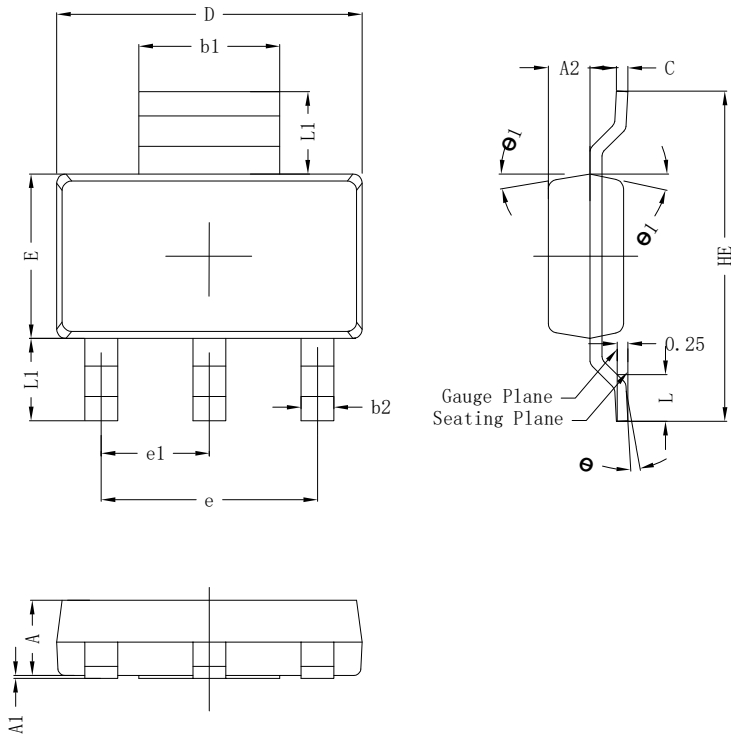

| SOT223 | | | |
|----------------------|-----------|------|------|
| DIM | MIN | NOR | MAX |
| A | 1.50 | 1.60 | 1.70 |
| A1 | 0.00 | 0.05 | 0.10 |
| A2 | 0.80 | 0.90 | 1.00 |
| b1 | 2.90 | 3.02 | 3.10 |
| b2 | 0.60 | 0.72 | 0.80 |
| c | 0.20 | 0.27 | 0.35 |
| D | 6.30 | 6.50 | 6.70 |
| E | 3.30 | 3.50 | 3.70 |
| e | 4.60BSC | | |
| e1 | 2.30BSC | | |
| HE | 6.80 | 7.00 | 7.20 |
| L | 0.80 | 1.00 | 1.20 |
| L1 | 1.75(REF) | | |
| θ | 0°~8° | | |
| θ 1 | 8° | 10° | 12° |
| All Dimensions in mm | | | |

GENERAL NOTES

1. Top package surface finish Ra0.4±0.2um
2. Bottom package surface finish Ra0.7±0.2um
3. Side package surface finish Ra0.4±0.2um
4. Protrusion or Gate Burrs shall not exceed 0.10mm per side.

9.SOLDERING FOOTPRINT

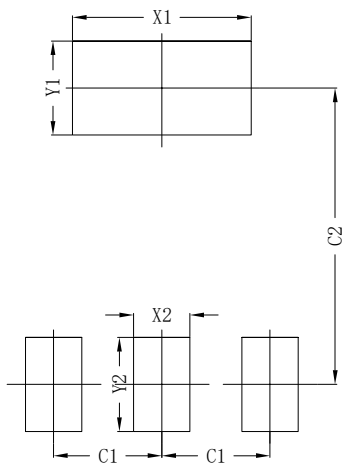

| SOT223 | |
|--------|------|
| DIM | (mm) |
| X1 | 3.80 |
| Y1 | 2.00 |
| X2 | 1.20 |
| Y2 | 2.00 |
| C1 | 2.30 |
| C2 | 6.30 |

DISCLAIMER

- Curve guarantee in the specification. The curve of test items with electric parameter is used as quality guarantee. The curve of test items without electric parameter is used as reference only.
- Before you use our Products for new Project, you are requested to carefully read this document and fully understand its contents. LRC shall not be in any way responsible or liable for failure, malfunction or accident arising from the use of any LRC's Products against warning, caution or note contained in this document.
- All information contained in this document is current as of the issuing date and subject to change without any prior notice. Before purchasing or using LRC's Products, please confirm the latest information with a LRC sales representative.

单击下面可查看定价，库存，交付和生命周期等信息

[>>LRC\(乐山无线电\)](#)