

# Dual Bias Resistor Transistors

## NPN and PNP Silicon Surface Mount

### Transistors with Monolithic Bias

### Resistor Network

The BRT (Bias Resistor Transistor) contains a single transistor with a monolithic bias network consisting of two resistors; a series base resistor and a base-emitter resistor. These digital transistors are designed to replace a single device and its external resistor bias network. The BRT eliminates these individual components by integrating them into a single device. In the LMUN5311DW1T1G series, two complementary BRT devices are housed in the SOT-363 package which is ideal for low power surface mount applications where board space is at a premium.

- Simplifies Circuit Design
- Reduces Board Space
- Reduces Component Count
- We declare that the material of product compliance with RoHS requirements and Halogen Free.
- S- prefix for automotive and other applications requiring unique site and control change requirements; AEC-Q101 qualified and PPAP capable.

#### MAXIMUM RATINGS (T<sub>A</sub> = 25°C unless otherwise noted, common for Q<sub>1</sub>

and Q<sub>2</sub>, – minus sign for Q<sub>1</sub> (PNP omitted)

Rating	Symbol	Value	Unit
Collector-Base Voltage	V <sub>CBO</sub>	50	Vdc
Collector-Emitter Voltage	V <sub>CEO</sub>	50	Vdc
Collector Current	I <sub>C</sub>	100	mAdc

#### THERMAL CHARACTERISTICS

Characteristic (One Junction Heated)	Symbol	Max	Unit
Total Device Dissipation T <sub>A</sub> = 25°C	P <sub>D</sub>	187 (Note 1.) 256 (Note 2.)	mW
Derate above 25°C		1.5 (Note 1.) 2.0 (Note 2.)	mW/°C
Thermal Resistance – Junction-to-Ambient	R <sub>θJA</sub>	670 (Note 1.) 490 (Note 2.)	°C/W
Characteristic (Both Junctions Heated)	Symbol	Max	Unit
Total Device Dissipation T <sub>A</sub> = 25°C	P <sub>D</sub>	250 (Note 1.) 385 (Note 2.)	mW
Derate above 25°C		2.0 (Note 1.) 3.0 (Note 2.)	mW/°C
Thermal Resistance – Junction-to-Ambient	R <sub>θJA</sub>	493 (Note 1.) 325 (Note 2.)	°C/W
Thermal Resistance – Junction-to-Lead	R <sub>θJL</sub>	188 (Note 1.) 208 (Note 2.)	°C/W
Junction and Storage Temperature	T <sub>J</sub> , T <sub>stg</sub>	-55 to +150	°C

1. FR-4 @ Minimum Pad      2. FR-4 @ 1.0 x 1.0 inch Pad

LMUN5311DW1T1G  
Series  
S-LMUN5311DW1T1G  
Series

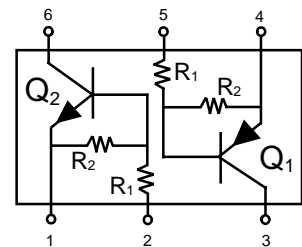
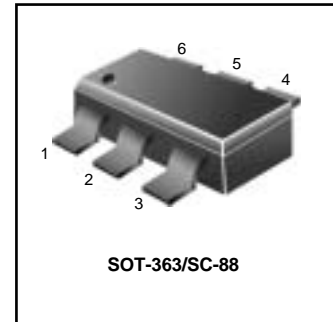

#### MARKING DIAGRAM

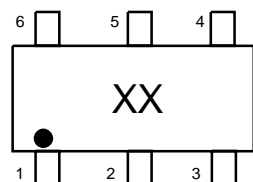

xx = Device Marking  
(See Page 2)

#### DEVICE MARKING INFORMATION

See specific marking information in the device marking table on page 2 of this data sheet.

LMUN5311DW1T1G Series S-LMUN5311DW1T1G Series

ORDERING, SHIPPING, DEVICE MARKING AND RESISTOR VALUES

Device	Package	Marking	R1(K)	R2(K)	Shipping
LMUN5311DW1T1G	SOT-363	11	10	10	3000/Tape&Reel
LMUN5311DW1T3G	SOT-363	11	10	10	10000/Tape&Reel
LMUN5312DW1T1G	SOT-363	12	22	22	3000/Tape&Reel
LMUN5312DW1T3G	SOT-363	12	22	22	10000/Tape&Reel
LMUN5313DW1T1G	SOT-363	13	47	47	3000/Tape&Reel
LMUN5313DW1T3G	SOT-363	13	47	47	10000/Tape&Reel
LMUN5314DW1T1G	SOT-363	14	10	47	3000/Tape&Reel
LMUN5314DW1T3G	SOT-363	14	10	47	10000/Tape&Reel
LMUN5315DW1T1G	SOT-363	15	10	∞	3000/Tape&Reel
LMUN5315DW1T3G	SOT-363	15	10	∞	10000/Tape&Reel
LMUN5316DW1T1G	SOT-363	16	4.7	∞	3000/Tape&Reel
LMUN5316DW1T3G	SOT-363	16	4.7	∞	10000/Tape&Reel
LMUN5330DW1T1G	SOT-363	30	1	1	3000/Tape&Reel
LMUN5330DW1T3G	SOT-363	30	1	1	10000/Tape&Reel
LMUN5331DW1T1G	SOT-363	31	2.2	2.2	3000/Tape&Reel
LMUN5331DW1T3G	SOT-363	31	2.2	2.2	10000/Tape&Reel
LMUN5332DW1T1G	SOT-363	32	4.7	4.7	3000/Tape&Reel
LMUN5332DW1T3G	SOT-363	32	4.7	4.7	10000/Tape&Reel
LMUN5333DW1T1G	SOT-363	33	4.7	47	3000/Tape&Reel
LMUN5333DW1T3G	SOT-363	33	4.7	47	10000/Tape&Reel
LMUN5334DW1T1G	SOT-363	34	22	47	3000/Tape&Reel
LMUN5334DW1T3G	SOT-363	34	22	47	10000/Tape&Reel
LMUN5335DW1T1G	SOT-363	35	2.2	47	3000/Tape&Reel
LMUN5335DW1T3G	SOT-363	35	2.2	47	10000/Tape&Reel

**LMUN5311DW1T1G Series S-LMUN5311DW1T1G Series**

**ELECTRICAL CHARACTERISTICS**

(T<sub>A</sub> = 25°C unless otherwise noted, common for Q<sub>1</sub> and Q<sub>2</sub>, – minus sign for Q<sub>1</sub> (PNP) omitted) (Continued)

Characteristic	Symbol	Min	Typ	Max	Unit	
<b>ON CHARACTERISTICS</b> (Note 4)						
DC Current Gain (V <sub>CE</sub> = 10 V, I <sub>C</sub> = 5.0 mA)	LMUN5311DW1T1G LMUN5312DW1T1G LMUN5313DW1T1G LMUN5314DW1T1G LMUN5315DW1T1G LMUN5316DW1T1G LMUN5330DW1T1G LMUN5331DW1T1G LMUN5332DW1T1G LMUN5333DW1T1G LMUN5334DW1T1G LMUN5335DW1T1G	h <sub>FE</sub>	35 60 80 80 160 160 3.0 8.0 15 80 80 80	60 100 140 140 350 350 5.0 15 30 200 150 140	– – – – – – – – – – – –	
Collector-Emitter Saturation Voltage (I <sub>C</sub> = 10 mA, I <sub>B</sub> = 0.3 mA) (I <sub>C</sub> = 10 mA, I <sub>B</sub> = 5 mA) LMUN5330DW1T1G/LMUN5331DW1T1G (I <sub>C</sub> = 10 mA, I <sub>B</sub> = 1 mA) LMUN5315DW1T1G/LMUN5316DW1T1G LMUN5332DW1T1G/LMUN5333DW1T1G/LMUN5334DW1T1G		V <sub>CE(sat)</sub>	–	–	0.25	Vdc
Output Voltage (on) (V <sub>CC</sub> = 5.0 V, V <sub>B</sub> = 2.5 V, R <sub>L</sub> = 1.0 kΩ)	LMUN5311DW1T1G LMUN5312DW1T1G LMUN5314DW1T1G LMUN5315DW1T1G LMUN5316DW1T1G LMUN5330DW1T1G LMUN5331DW1T1G LMUN5332DW1T1G LMUN5333DW1T1G LMUN5334DW1T1G LMUN5335DW1T1G (V <sub>CC</sub> = 5.0 V, V <sub>B</sub> = 3.5 V, R <sub>L</sub> = 1.0 kΩ) LMUN5313DW1T1G	V <sub>OL</sub>	– – – – – – – – – – – –	– – – – – – – – – – – –	0.2 0.2 0.2 0.2 0.2 0.2 0.2 0.2 0.2 0.2 0.2 0.2	Vdc
Output Voltage (off) (V <sub>CC</sub> = 5.0 V, V <sub>B</sub> = 0.5 V, R <sub>L</sub> = 1.0 kΩ) (V <sub>CC</sub> = 5.0 V, V <sub>B</sub> = 0.050 V, R <sub>L</sub> = 1.0 kΩ) LMUN5330DW1T1G (V <sub>CC</sub> = 5.0 V, V <sub>B</sub> = 0.25 V, R <sub>L</sub> = 1.0 kΩ) LMUN5315DW1T1G LMUN5316DW1T1G LMUN5333DW1T1G		V <sub>OH</sub>	4.9	–	–	Vdc
Input Resistor	LMUN5311DW1T1G LMUN5312DW1T1G LMUN5313DW1T1G LMUN5314DW1T1G LMUN5315DW1T1G LMUN5316DW1T1G LMUN5330DW1T1G LMUN5331DW1T1G LMUN5332DW1T1G LMUN5333DW1T1G LMUN5334DW1T1G LMUN5335DW1T1G	R1	7.0 15.4 32.9 7.0 7.0 3.3 0.7 1.5 3.3 3.3 15.4 1.54	10 22 47 10 10 4.7 1.0 2.2 4.7 4.7 22 2.2	13 28.6 61.1 13 13 6.1 1.3 2.9 6.1 6.1 28.6 2.86	k Ω
Resistor Ratio	LMUN5311DW1T1G/LMUN5312DW1T1G/LMUN5313DW1T1G LMUN5314DW1T1G LMUN5315DW1T1G/LMUN5316DW1T1G LMUN5330DW1T1G/LMUN5331DW1T1G/LMUN5332DW1T1G LMUN5333DW1T1G LMUN5334DW1T1G LMUN5335DW1T1G	R1/R2	0.8 0.17 – 0.8 0.055 0.38 0.038	1.0 0.21 – 1.0 0.1 0.47 0.047	1.2 0.25 – 1.2 0.185 0.56 0.056	

4. Pulse Test: Pulse Width < 300 μs, Duty Cycle < 2.0%

**LMUN5311DW1T1G Series S-LMUN5311DW1T1G Series**

**ELECTRICAL CHARACTERISTICS**

( $T_A = 25^\circ\text{C}$  unless otherwise noted, common for  $Q_1$  and  $Q_2$ , – minus sign for  $Q_1$  (PNP) omitted)

Characteristic	Symbol	Min	Typ	Max	Unit
<b>OFF CHARACTERISTICS</b>					
Collector-Base Cutoff Current ( $V_{CB} = 50\text{ V}, I_E = 0$ )	$I_{CBO}$	–	–	100	nAdc
Collector-Emitter Cutoff Current ( $V_{CE} = 50\text{ V}, I_B = 0$ )	$I_{CEO}$	–	–	500	nAdc
Emitter-Base Cutoff Current ( $V_{EB} = 6.0\text{ V}, I_C = 0$ )	LMUN5311DW1T1G	–	–	0.5	mAdc
	LMUN5312DW1T1G	–	–	0.2	
	LMUN5313DW1T1G	–	–	0.1	
	LMUN5314DW1T1G	–	–	0.2	
	LMUN5315DW1T1G	–	–	0.9	
	LMUN5316DW1T1G	–	–	1.9	
	LMUN5330DW1T1G	–	–	4.3	
	LMUN5331DW1T1G	–	–	2.3	
	LMUN5332DW1T1G	–	–	1.5	
	LMUN5333DW1T1G	–	–	0.18	
	LMUN5334DW1T1G	–	–	0.13	
LMUN5335DW1T1G	–	–	0.2		
Collector-Base Breakdown Voltage ( $I_C = 10\ \mu\text{A}, I_E = 0$ )	$V_{(BR)CBO}$	50	–	–	Vdc
Collector-Emitter Breakdown Voltage (Note 3) ( $I_C = 2.0\text{ mA}, I_B = 0$ )	$V_{(BR)CEO}$	50	–	–	Vdc

3. Pulse Test: Pulse Width < 300  $\mu\text{s}$ , Duty Cycle < 2.0%

**ALL LMUN5311DW1T1G SERIES DEVICES**

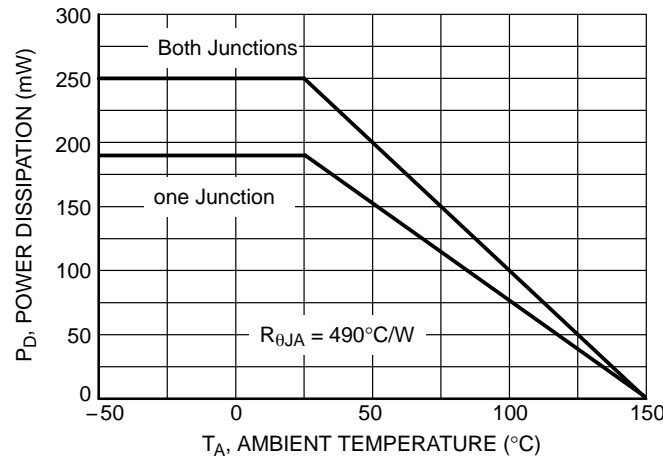

**Figure 1. Derating Curve**

LMUN5311DW1T1G Series S-LMUN5311DW1T1G Series

TYPICAL ELECTRICAL CHARACTERISTICS – LMUN5311DW1T1G NPN TRANSISTOR

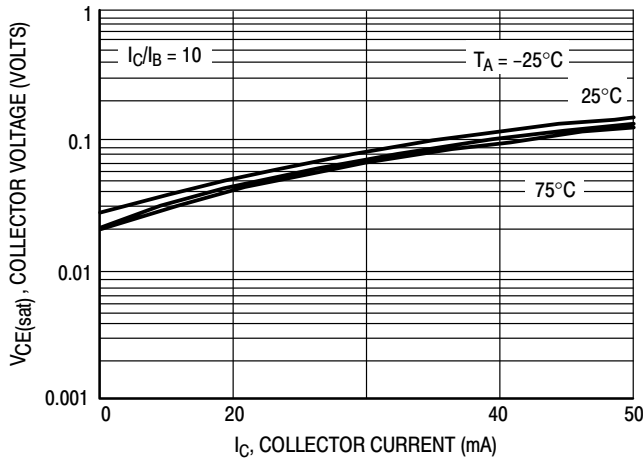

Figure 2.  $V_{CE(sat)}$  versus  $I_C$

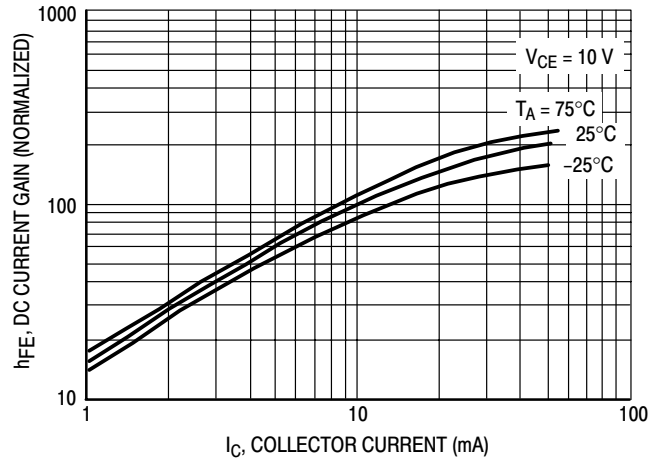

Figure 3. DC Current Gain

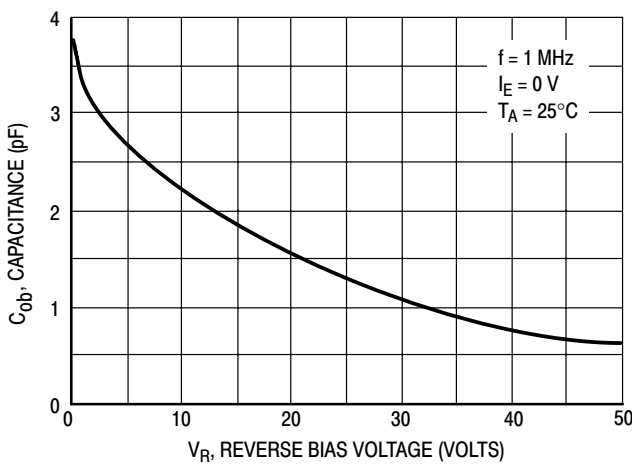

Figure 4. Output Capacitance

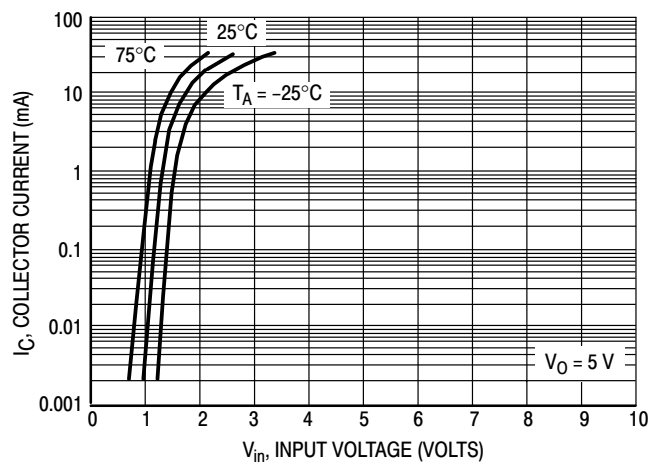

Figure 5. Output Current versus Input Voltage

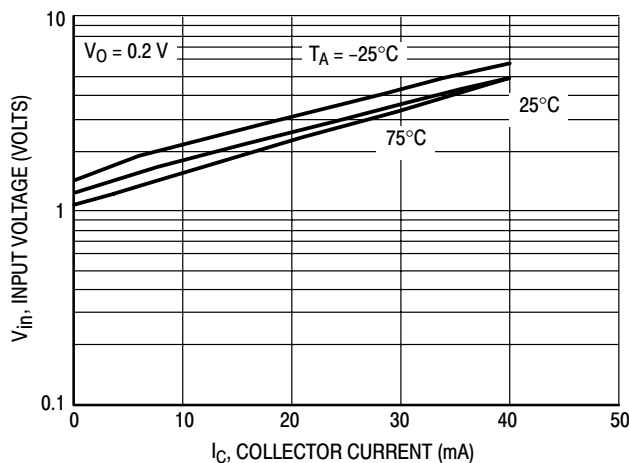

Figure 6. Input Voltage versus Output Current

LMUN5311DW1T1G Series S-LMUN5311DW1T1G Series

TYPICAL ELECTRICAL CHARACTERISTICS – LMUN5311DW1T1G PNP TRANSISTOR

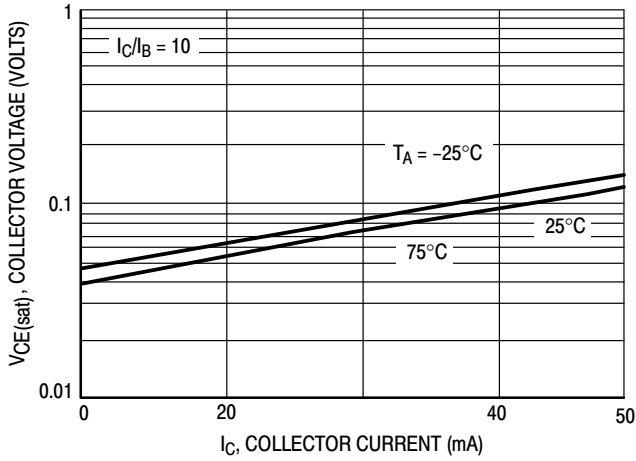

Figure 7.  $V_{CE(sat)}$  versus  $I_C$

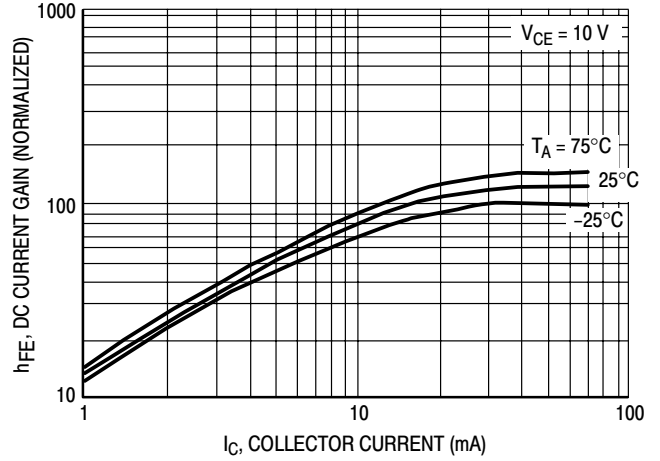

Figure 8. DC Current Gain

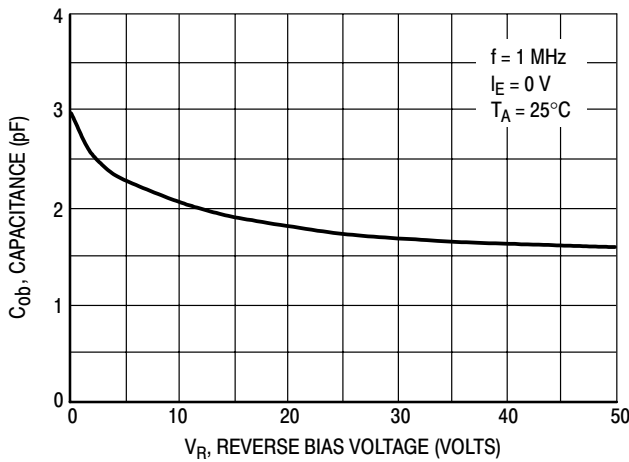

Figure 9. Output Capacitance

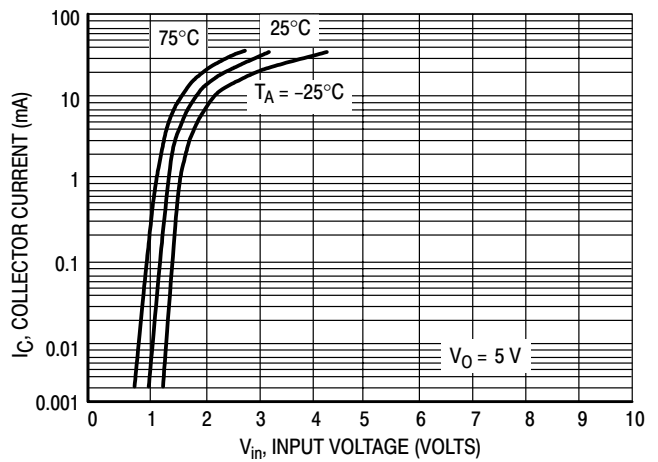

Figure 10. Output Current versus Input Voltage

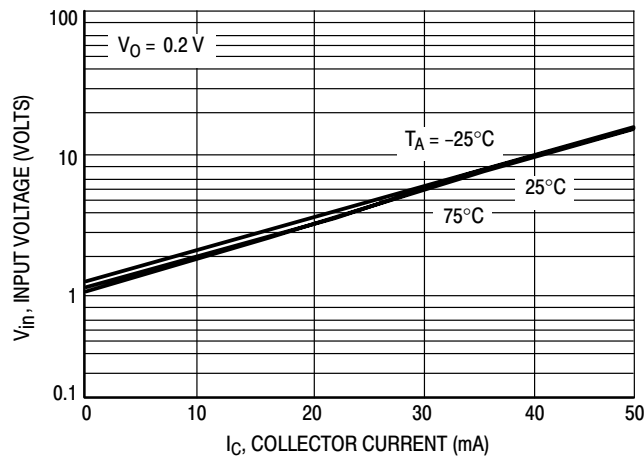

Figure 11. Input Voltage versus Output Current

LMUN5311DW1T1G Series S-LMUN5311DW1T1G Series

TYPICAL ELECTRICAL CHARACTERISTICS – LMUN5312DW1T1G NPN TRANSISTOR

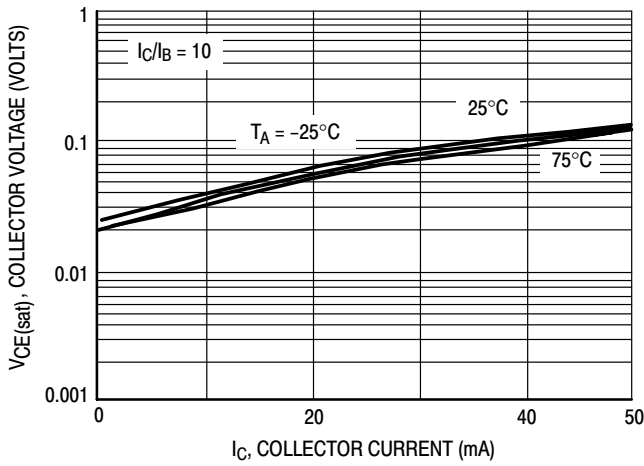

Figure 12.  $V_{CE(sat)}$  versus  $I_C$

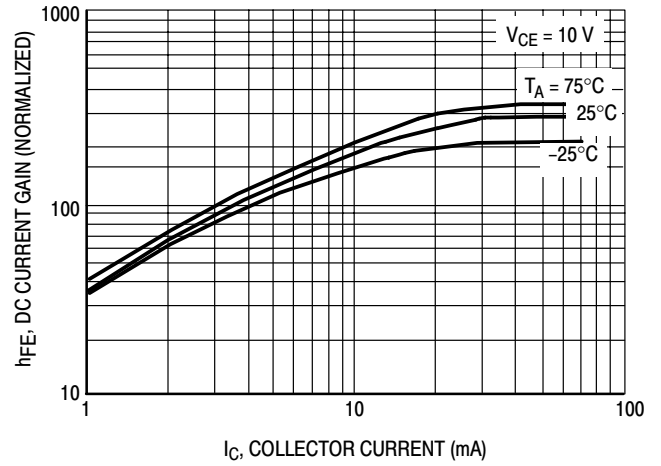

Figure 13. DC Current Gain

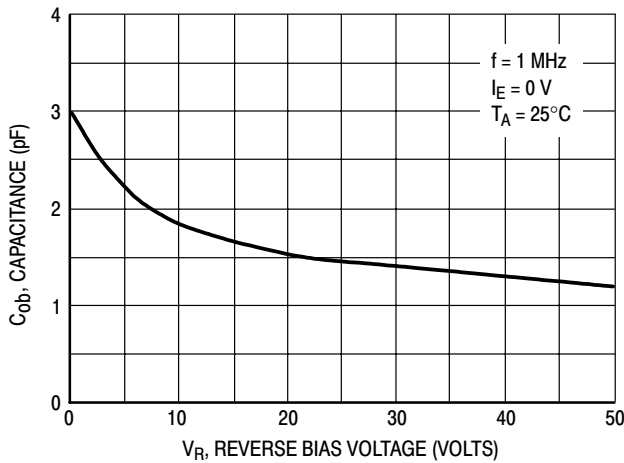

Figure 14. Output Capacitance

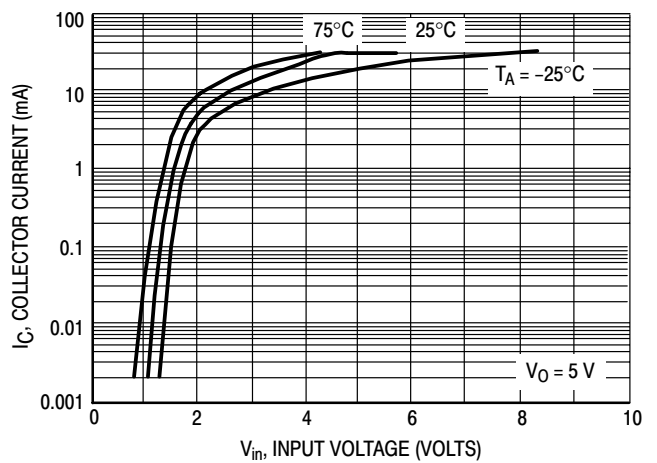

Figure 15. Output Current versus Input Voltage

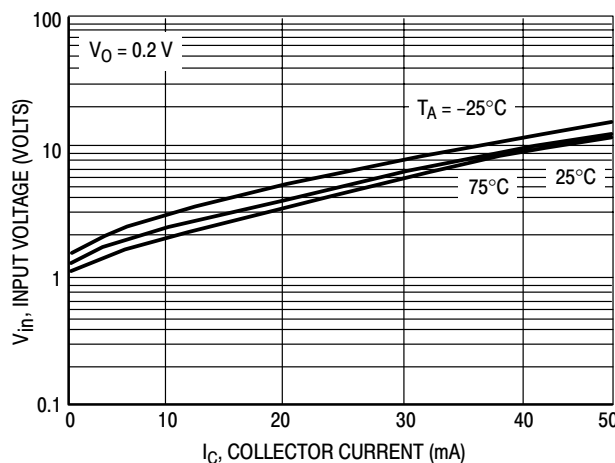

Figure 16. Input Voltage versus Output Current

LMUN5311DW1T1G Series S-LMUN5311DW1T1G Series

TYPICAL ELECTRICAL CHARACTERISTICS – LMUN5312DW1T1G PNP TRANSISTOR

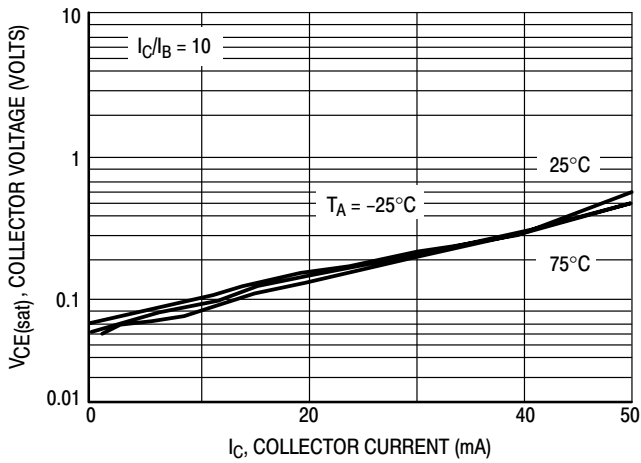

Figure 17.  $V_{CE(sat)}$  versus  $I_C$

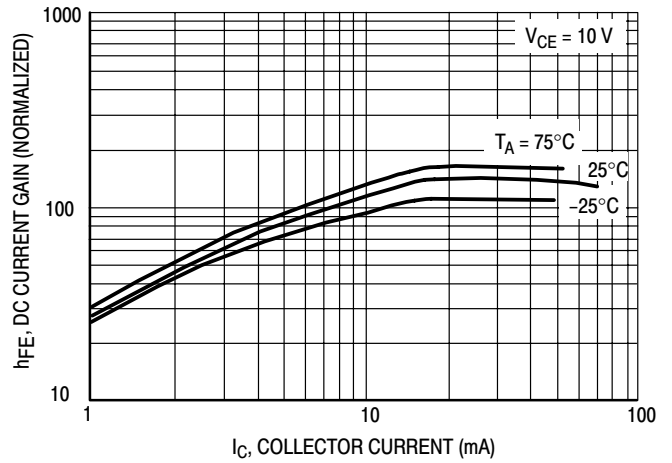

Figure 18. DC Current Gain

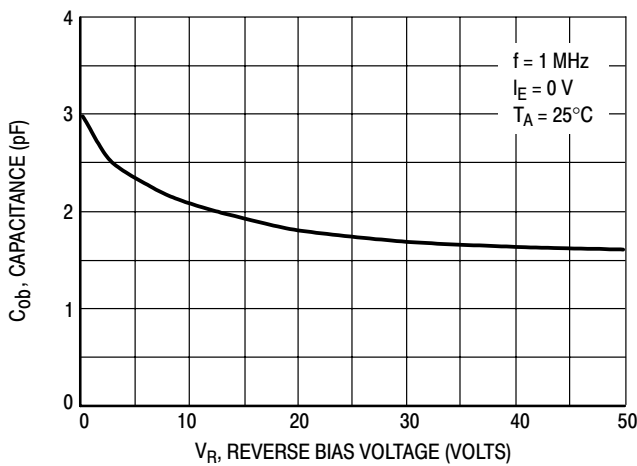

Figure 19. Output Capacitance

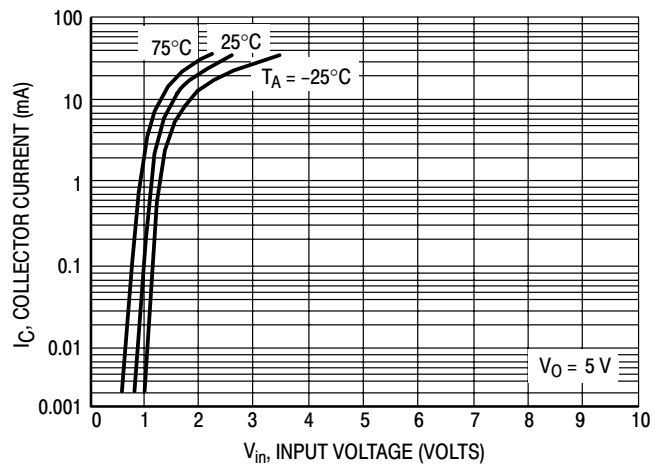

Figure 20. Output Current versus Input Voltage

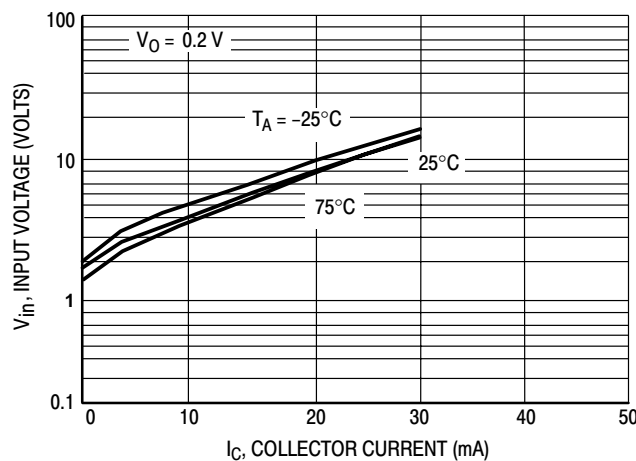

Figure 21. Input Voltage versus Output Current



LMUN5311DW1T1G Series S-LMUN5311DW1T1G Series

TYPICAL ELECTRICAL CHARACTERISTICS – LMUN5313DW1T1G NPN TRANSISTOR

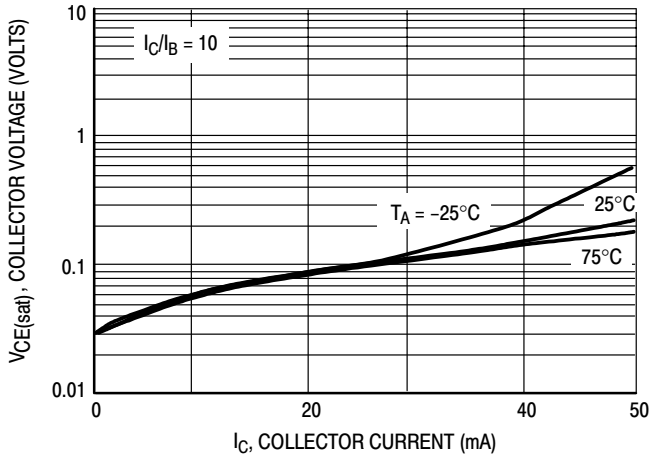

Figure 22.  $V_{CE(sat)}$  versus  $I_C$

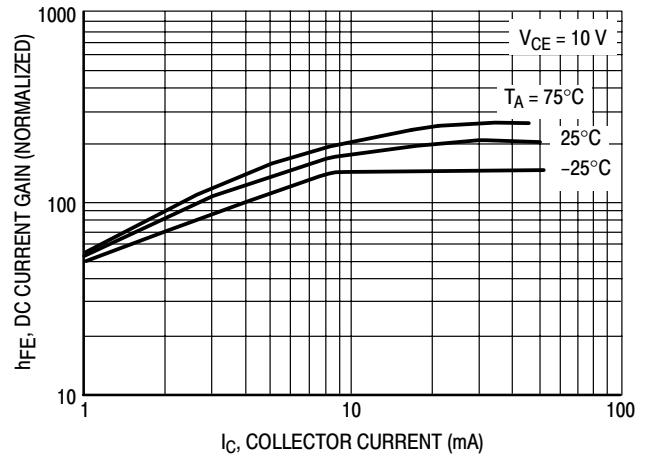

Figure 23. DC Current Gain

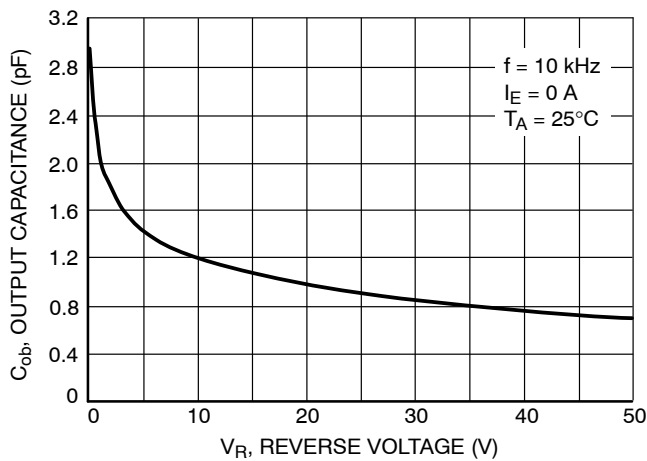

Figure 24. Output Capacitance

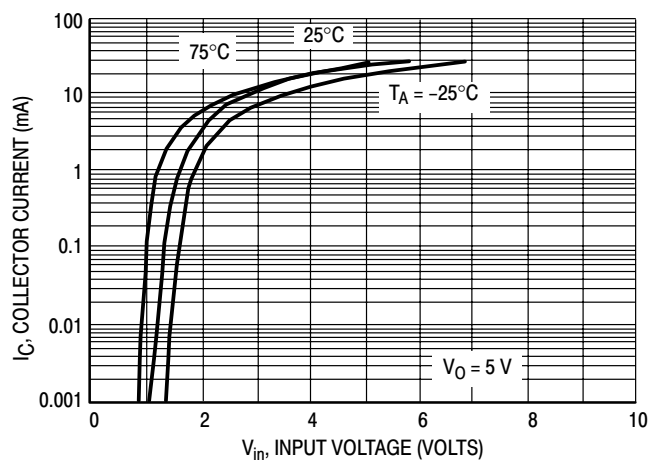

Figure 25. Output Current versus Input Voltage

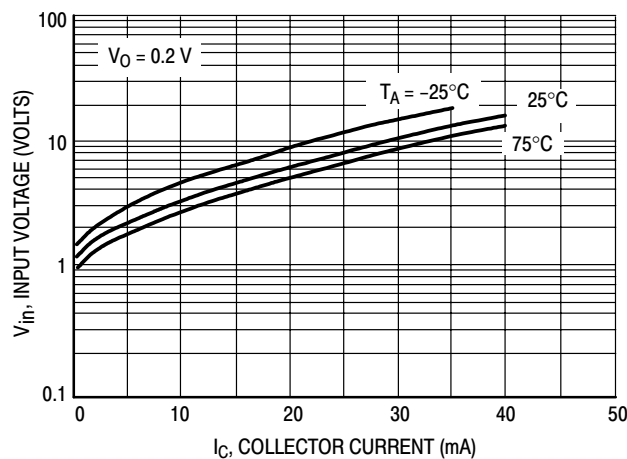

Figure 26. Input Voltage versus Output Current

LMUN5311DW1T1G Series S-LMUN5311DW1T1G Series

TYPICAL ELECTRICAL CHARACTERISTICS – LMUN5313DW1T1G PNP TRANSISTOR

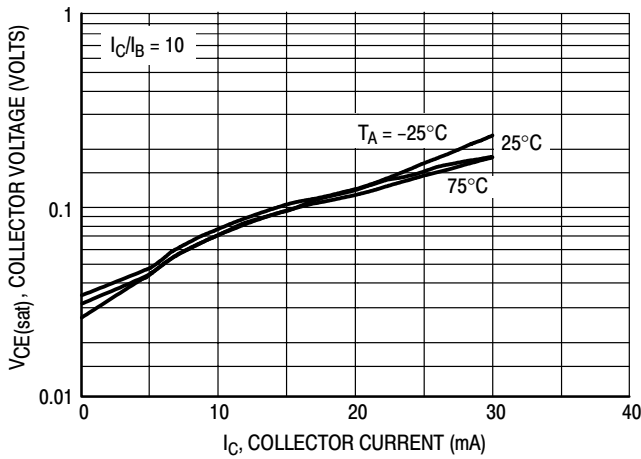

Figure 27.  $V_{CE(sat)}$  versus  $I_C$

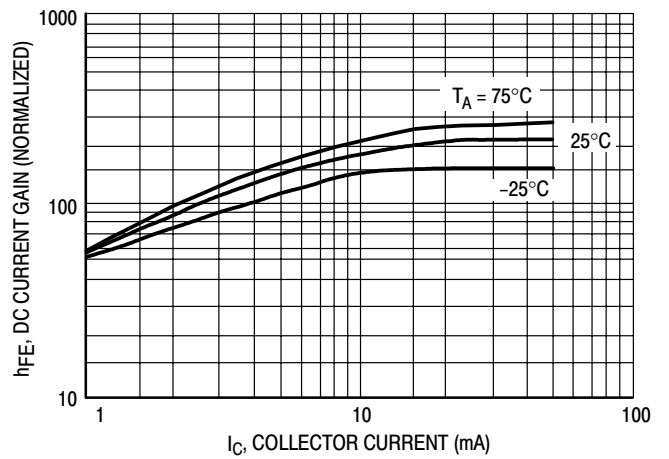

Figure 28. DC Current Gain

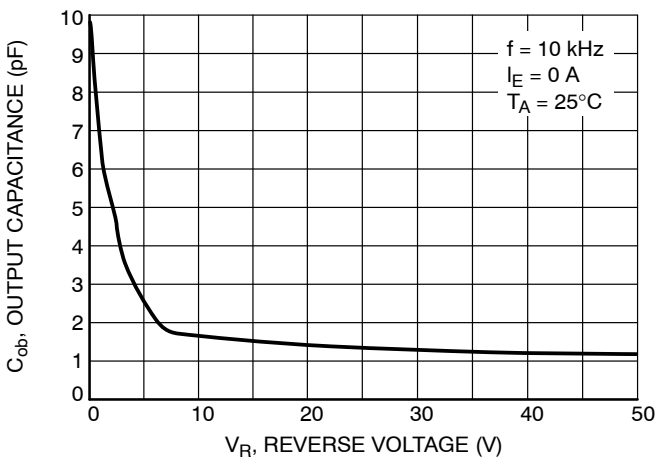

Figure 29. Output Capacitance

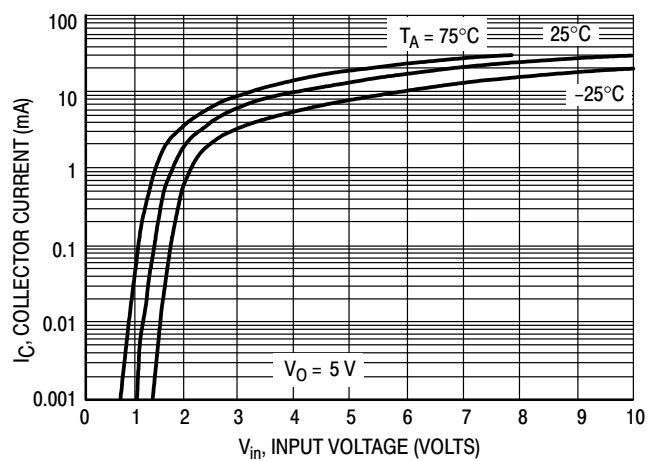

Figure 30. Output Current versus Input Voltage

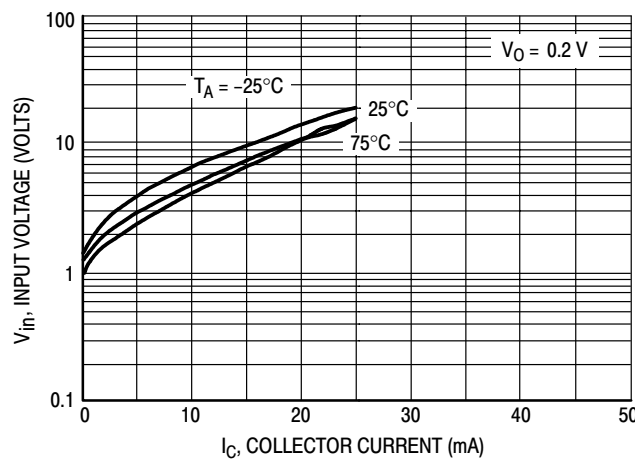

Figure 31. Input Voltage versus Output Current

LMUN5311DW1T1G Series S-LMUN5311DW1T1G Series

TYPICAL ELECTRICAL CHARACTERISTICS – LMUN5314DW1T1G NPN TRANSISTOR

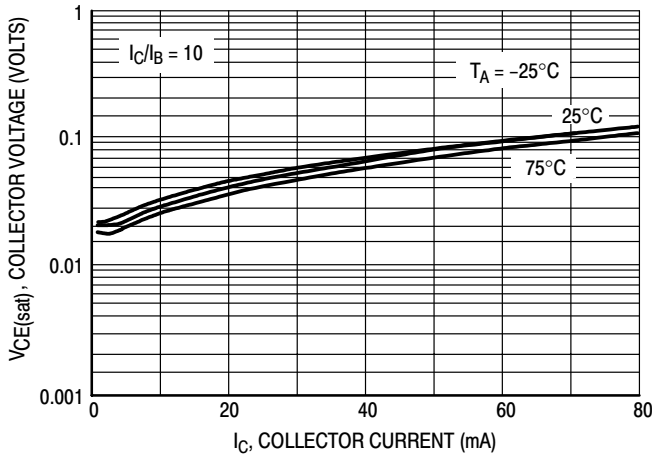

Figure 32.  $V_{CE(sat)}$  versus  $I_C$

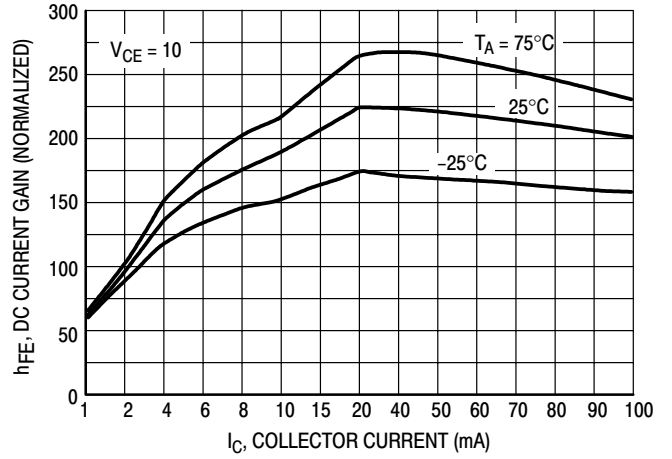

Figure 33. DC Current Gain

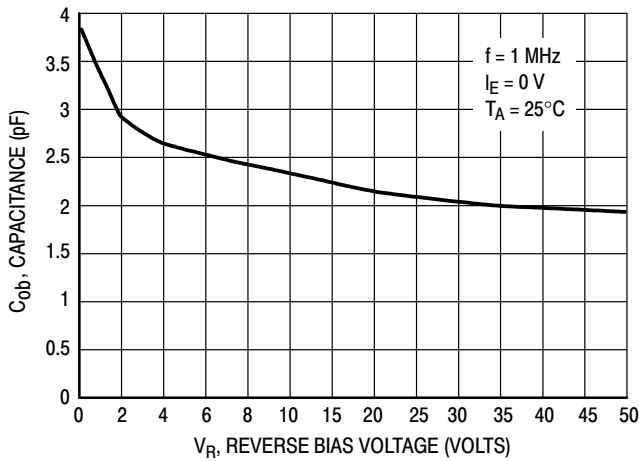

Figure 34. Output Capacitance

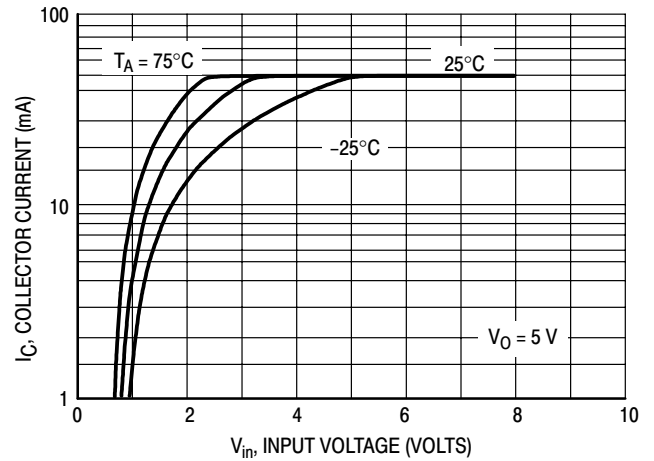

Figure 35. Output Current versus Input Voltage

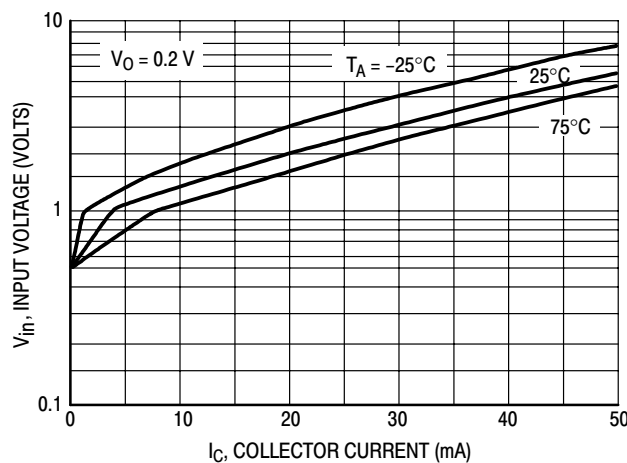

Figure 36. Input Voltage versus Output Current

LMUN5311DW1T1G Series S-LMUN5311DW1T1G Series

TYPICAL ELECTRICAL CHARACTERISTICS – LMUN5314DW1T1G PNP TRANSISTOR

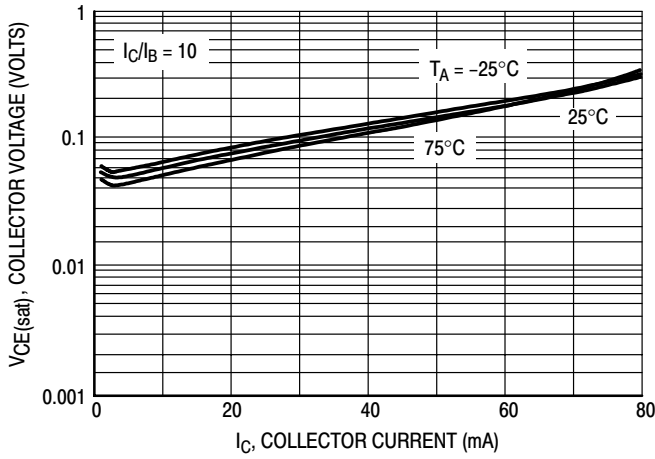

Figure 37.  $V_{CE(sat)}$  versus  $I_C$

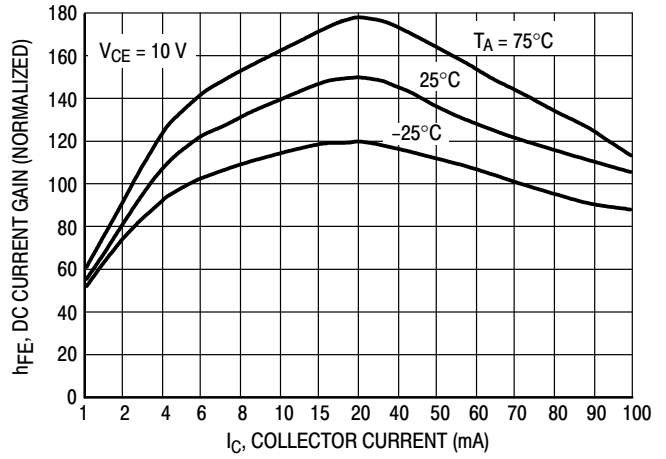

Figure 38. DC Current Gain

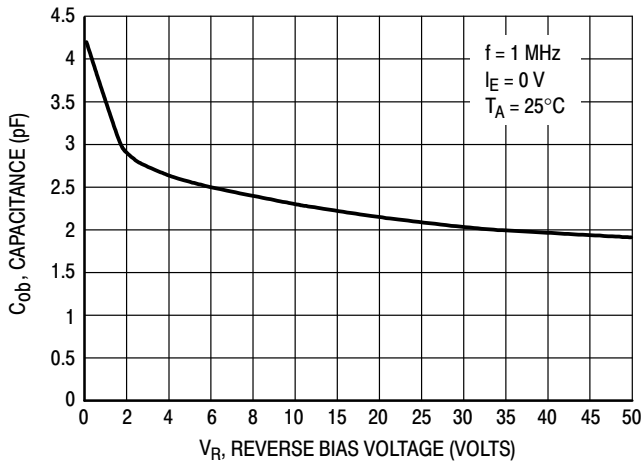

Figure 39. Output Capacitance

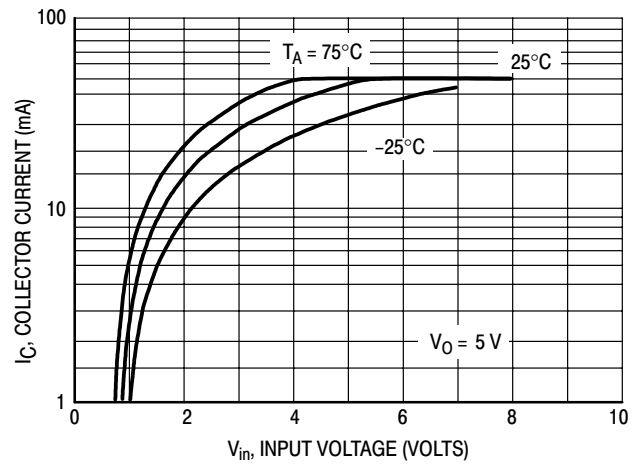

Figure 40. Output Current versus Input Voltage

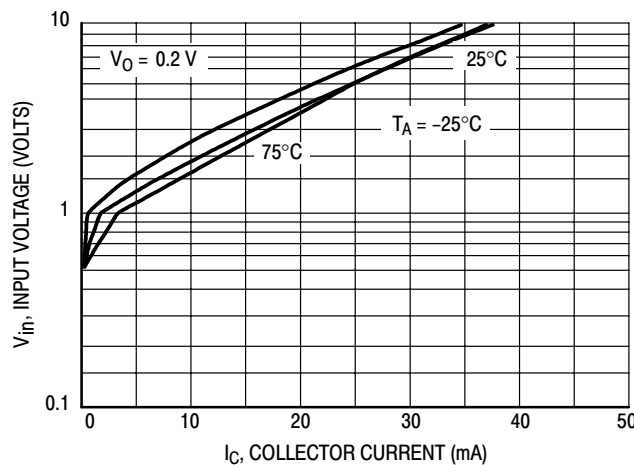

Figure 41. Input Voltage versus Output Current

LMUN5311DW1T1G Series S-LMUN5311DW1T1G Series

TYPICAL ELECTRICAL CHARACTERISTICS — LMUN5315DW1T1G NPN TRANSISTOR

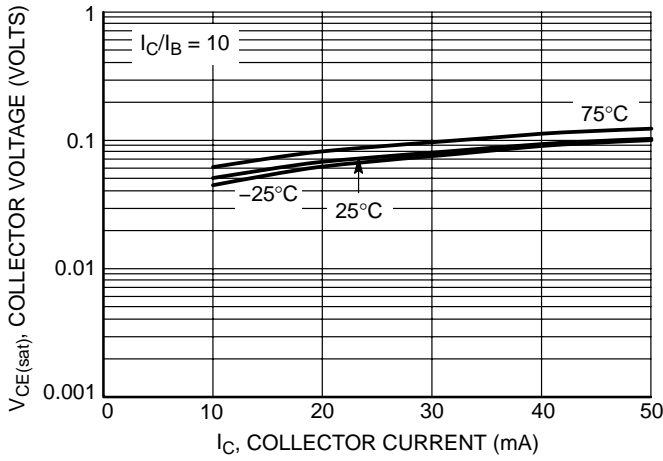

Figure 42.  $V_{CE(sat)}$  versus  $I_C$

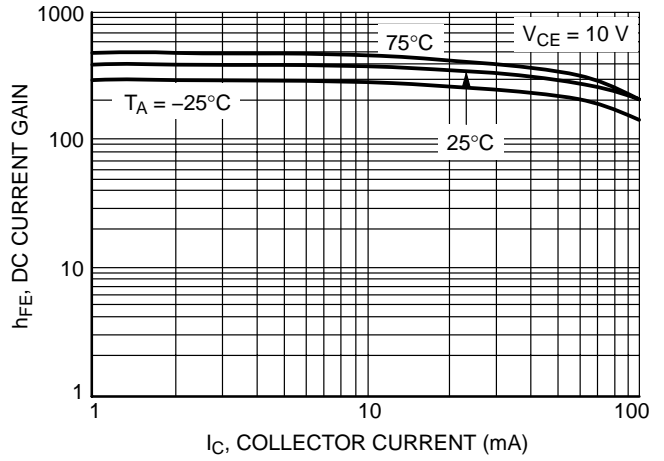

Figure 43. DC Current Gain

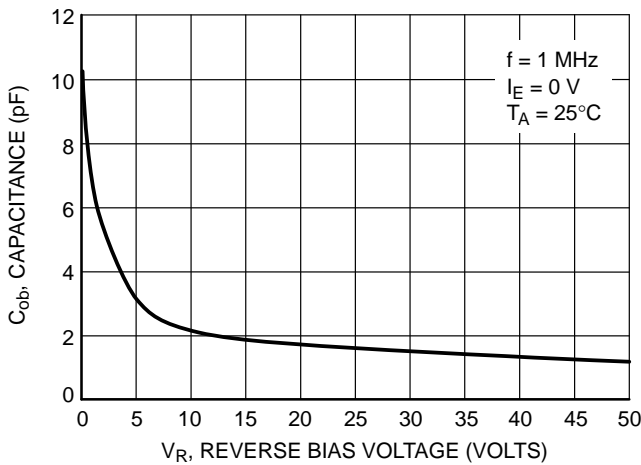

Figure 44. Output Capacitance

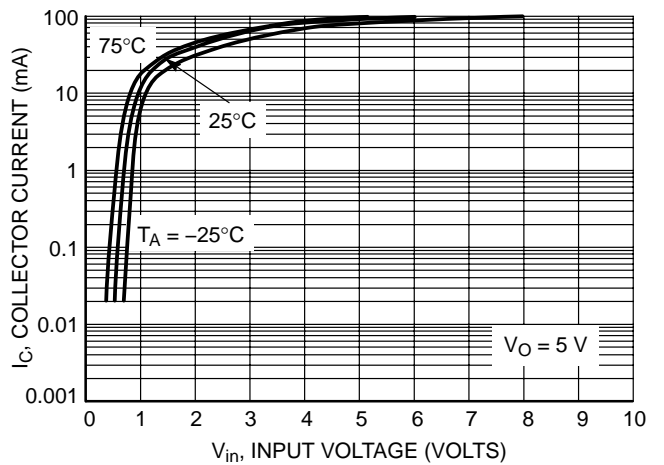

Figure 45. Output Current versus Input Voltage

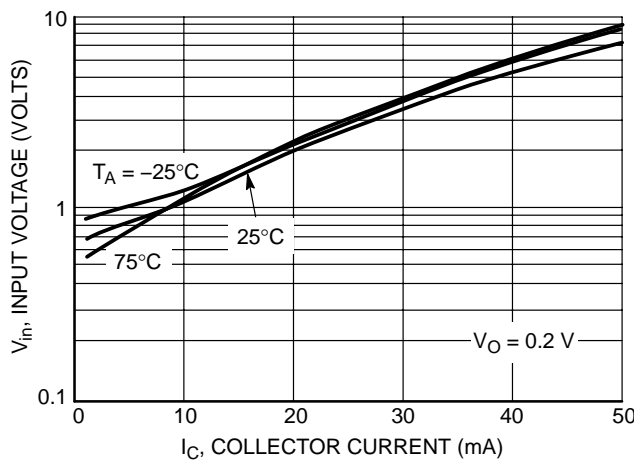

Figure 46. Input Voltage versus Output Current

LMUN5311DW1T1G Series S-LMUN5311DW1T1G Series

TYPICAL ELECTRICAL CHARACTERISTICS — LMUN5315DW1T1G PNP TRANSISTOR

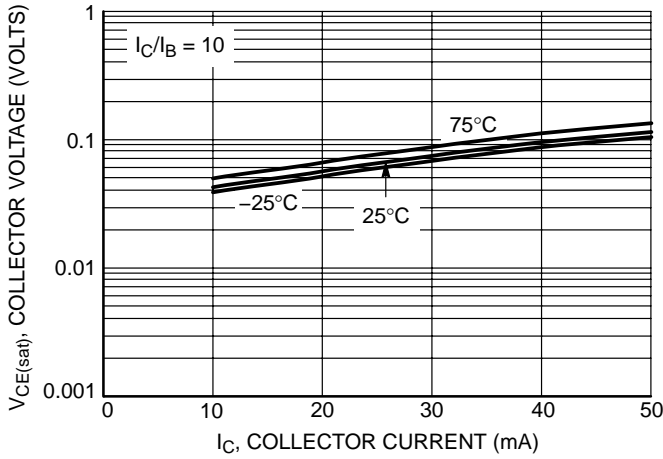

Figure 47.  $V_{CE(sat)}$  versus  $I_C$

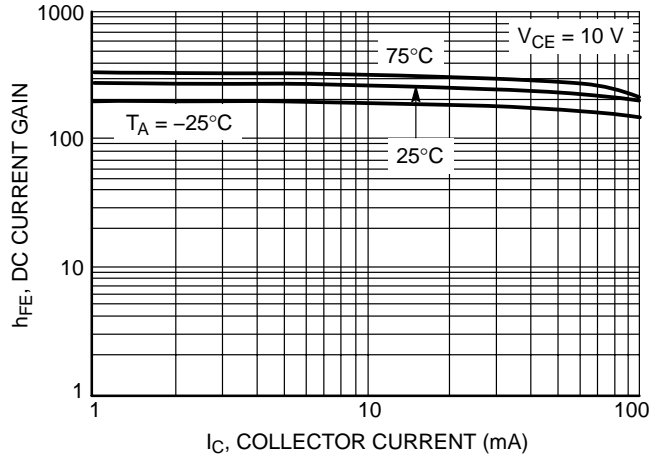

Figure 48. DC Current Gain

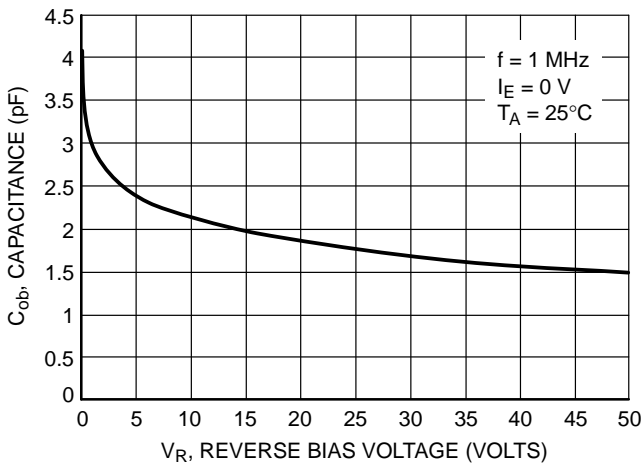

Figure 49. Output Capacitance

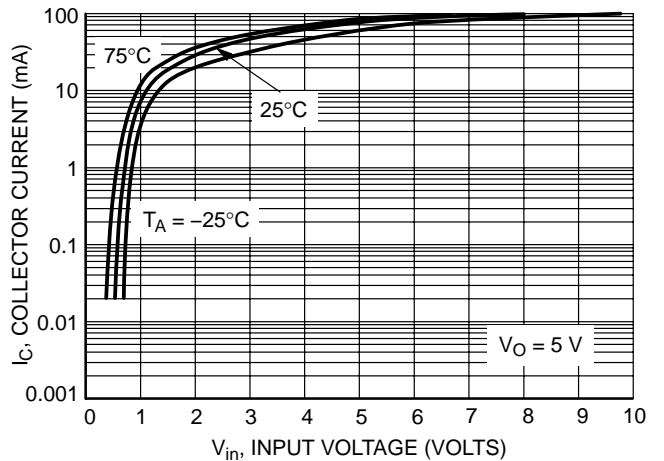

Figure 50. Output Current versus Input Voltage

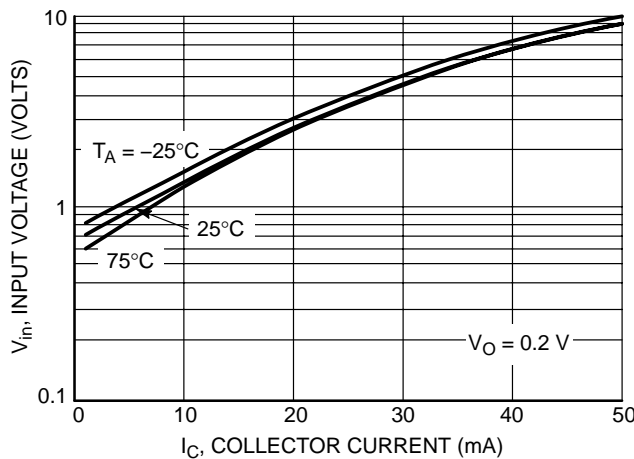

Figure 51. Input Voltage versus Output Current

LMUN5311DW1T1G Series S-LMUN5311DW1T1G Series

TYPICAL ELECTRICAL CHARACTERISTICS — LMUN5316DW1T1G NPN TRANSISTOR

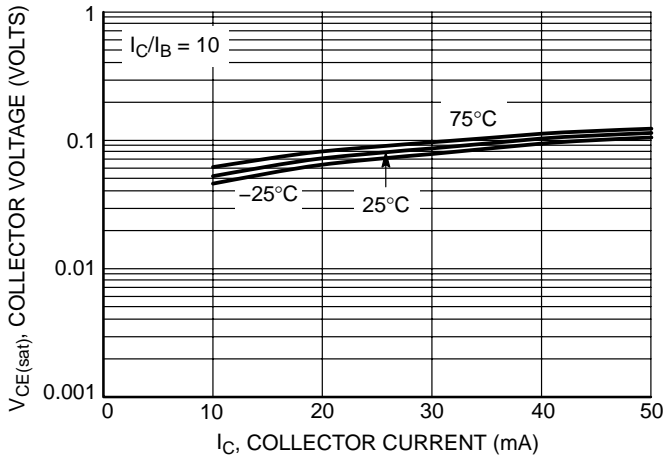

Figure 52.  $V_{CE(sat)}$  versus  $I_C$

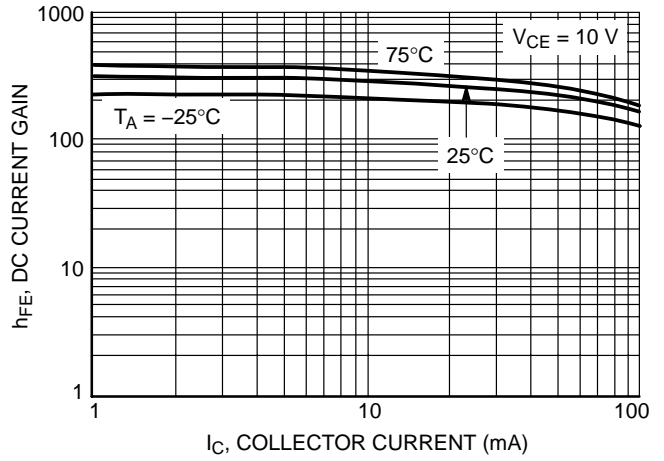

Figure 53. DC Current Gain

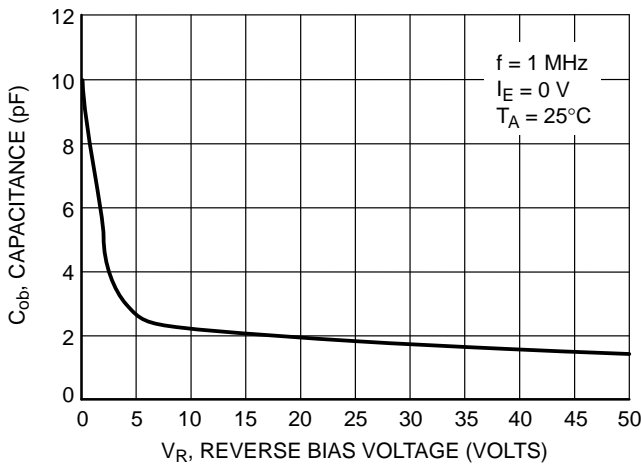

Figure 54. Output Capacitance

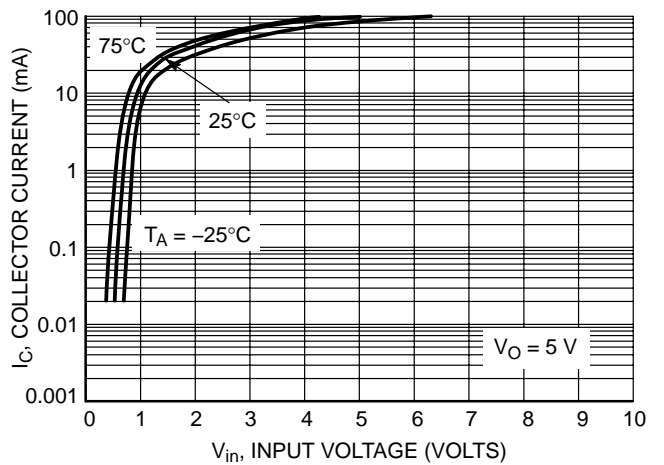

Figure 55. Output Current versus Input Voltage

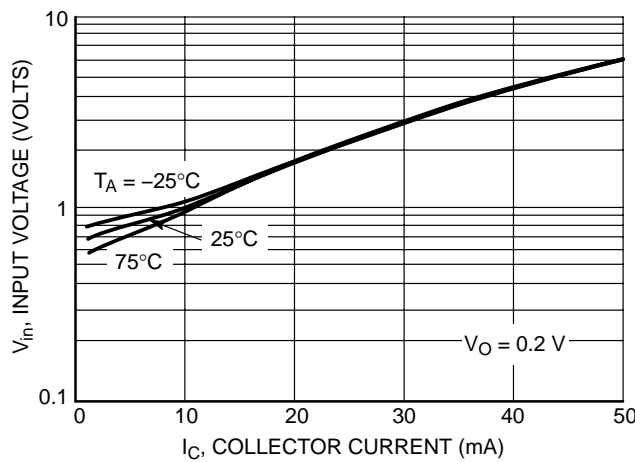

Figure 56. Input Voltage versus Output Current

LMUN5311DW1T1G Series S-LMUN5311DW1T1G Series

TYPICAL ELECTRICAL CHARACTERISTICS — LMUN5316DW1T1G PNP TRANSISTOR

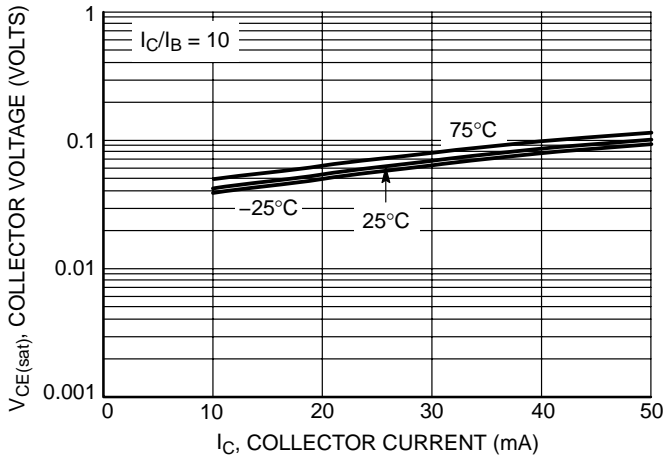

Figure 57.  $V_{CE(sat)}$  versus  $I_C$

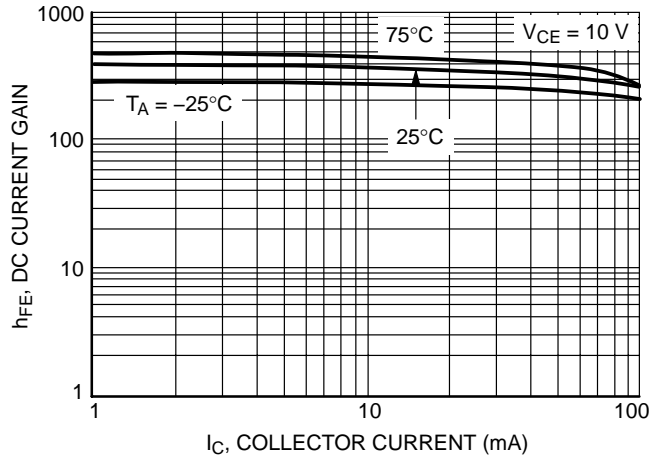

Figure 58. DC Current Gain

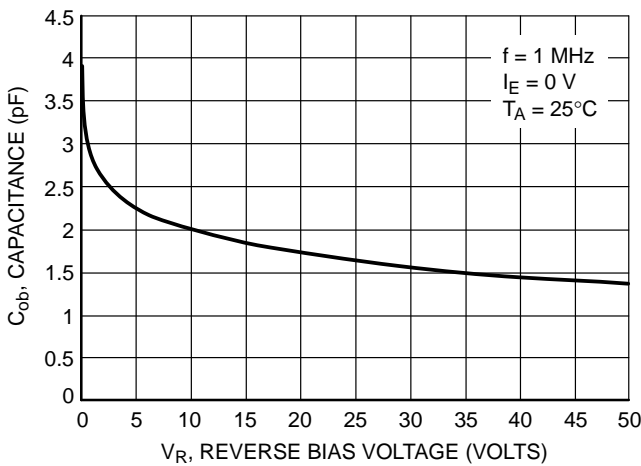

Figure 59. Output Capacitance

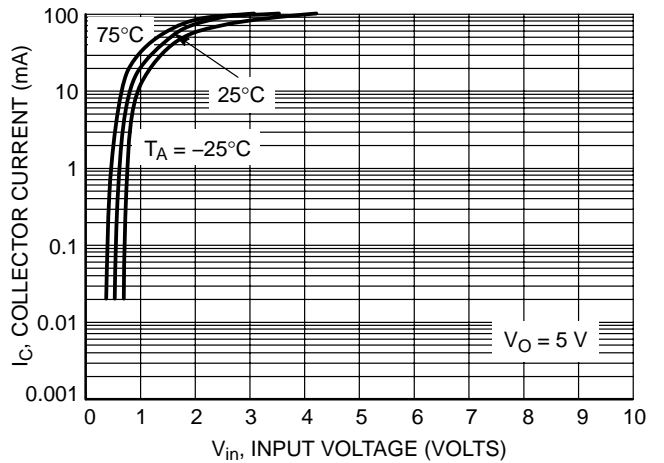

Figure 60. Output Current versus Input Voltage

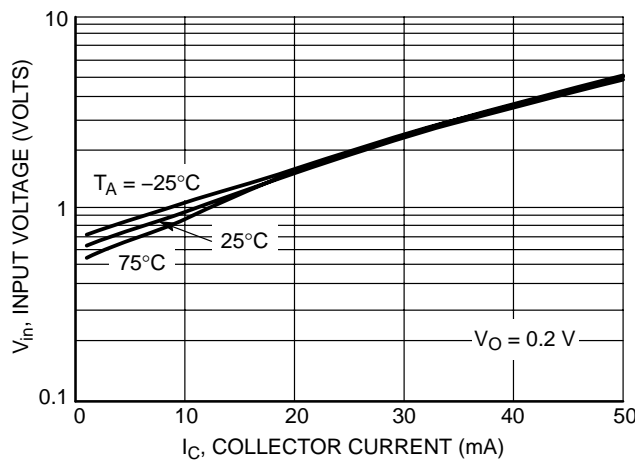

Figure 61. Input Voltage versus Output Current



LMUN5311DW1T1G Series S-LMUN5311DW1T1G Series

TYPICAL ELECTRICAL CHARACTERISTICS — LMUN5330DW1T1G NPN TRANSISTOR

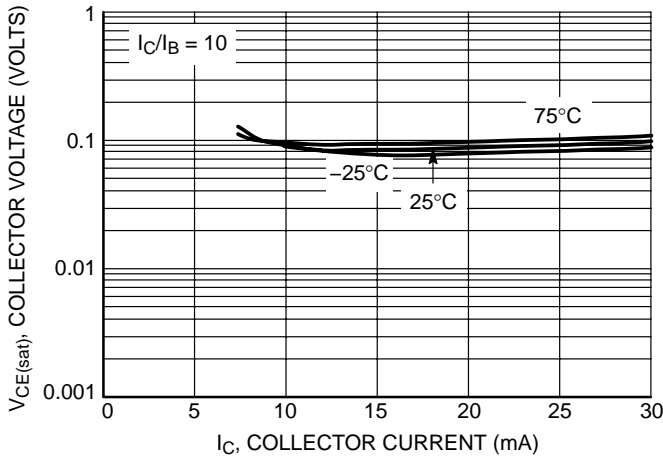

Figure 62.  $V_{CE(sat)}$  versus  $I_C$

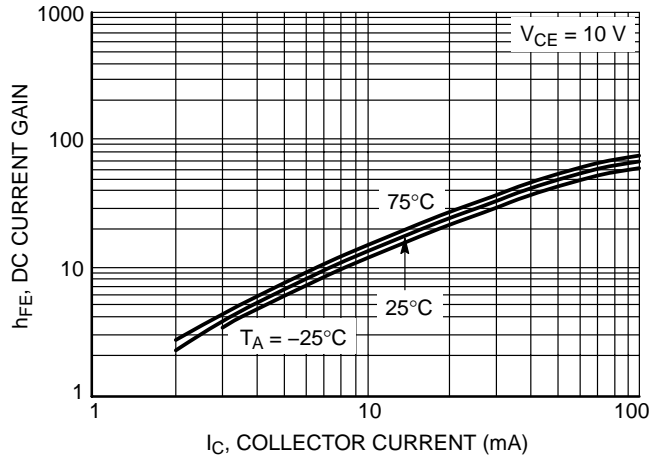

Figure 63. DC Current Gain

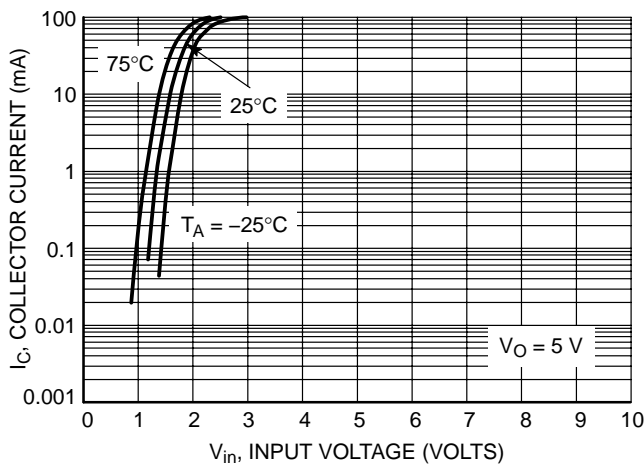

Figure 64. Output Current versus Input Voltage

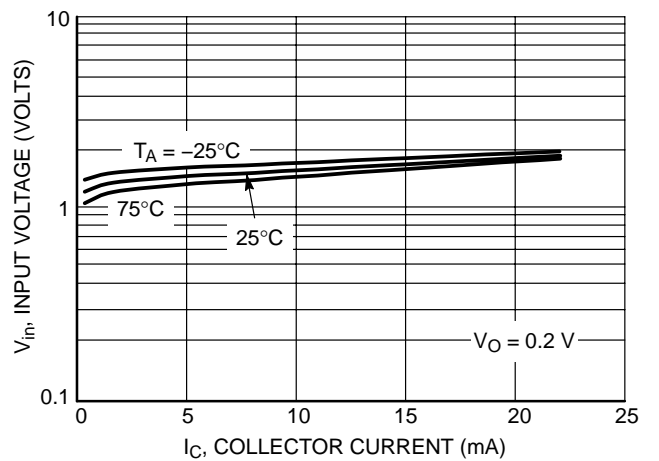

Figure 65. Input Voltage versus Output Current

LMUN5311DW1T1G Series S-LMUN5311DW1T1G Series

TYPICAL ELECTRICAL CHARACTERISTICS — LMUN5330DW1T1G PNP TRANSISTOR

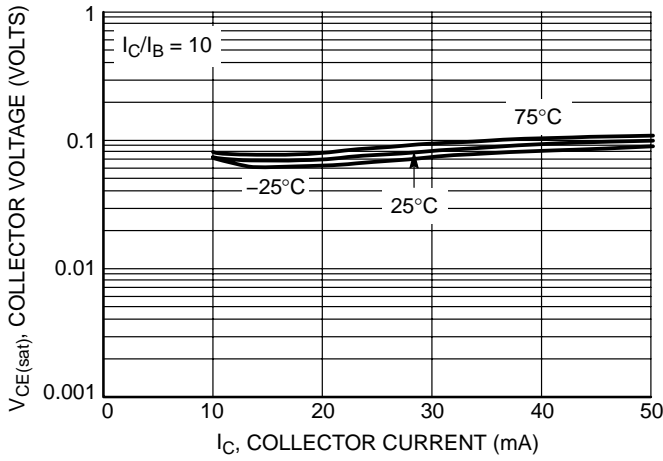

Figure 66.  $V_{CE(sat)}$  versus  $I_C$

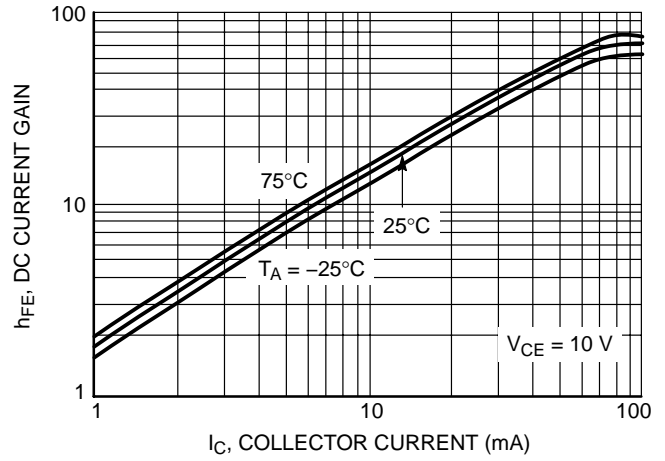

Figure 67. DC Current Gain

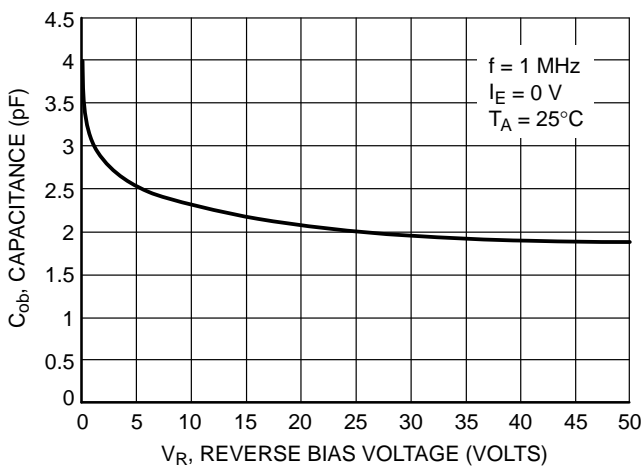

Figure 68. Output Capacitance

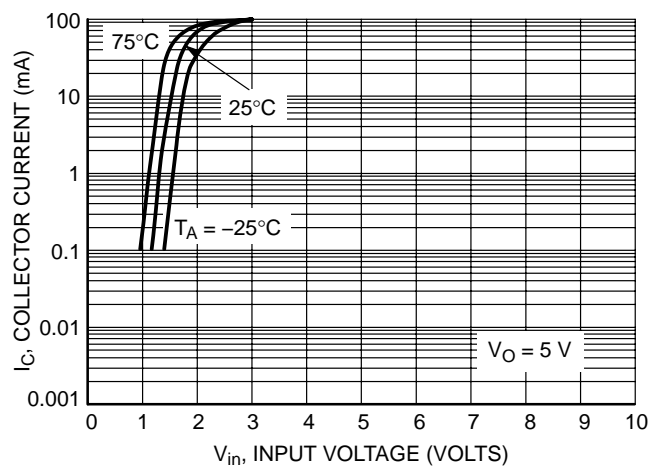

Figure 69. Output Current versus Input Voltage

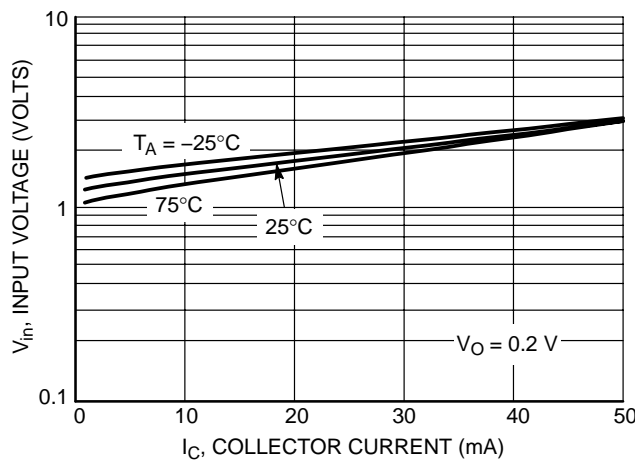

Figure 70. Input Voltage versus Output Current

LMUN5311DW1T1G Series S-LMUN5311DW1T1G Series

TYPICAL ELECTRICAL CHARACTERISTICS — LMUN5311DW1T1G PNP TRANSISTOR

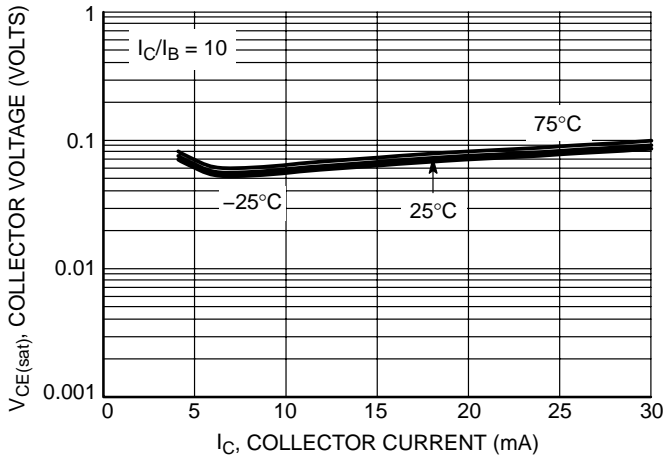

Figure 71.  $V_{CE(sat)}$  versus  $I_C$

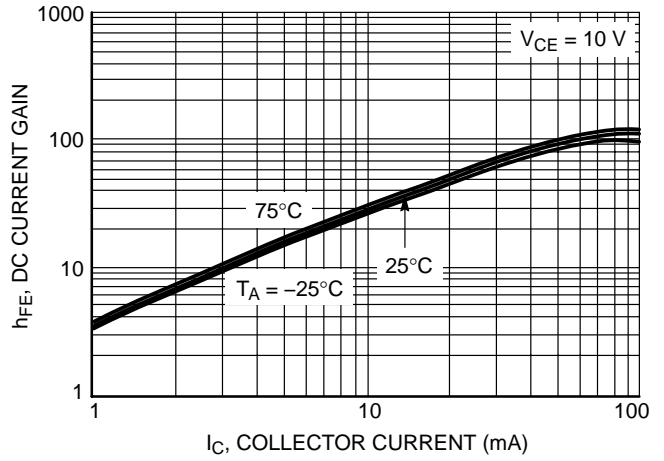

Figure 72. DC Current Gain

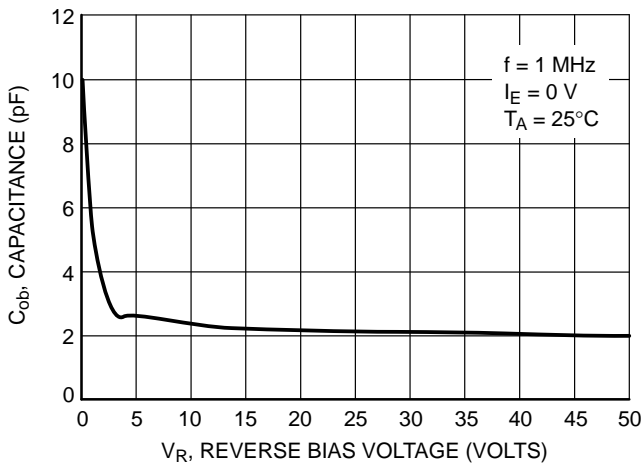

Figure 73. Output Capacitance

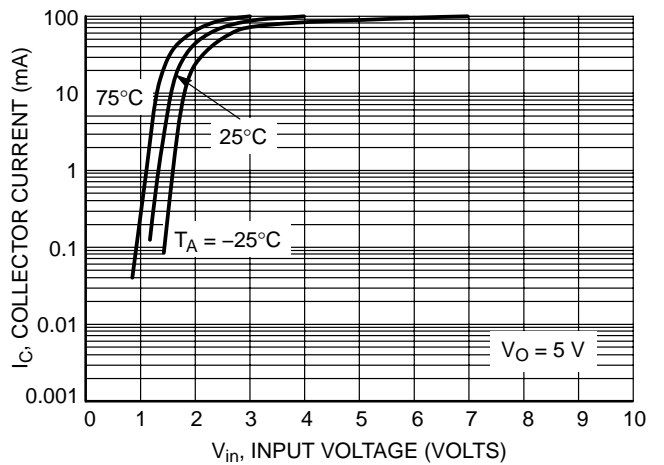

Figure 74. Output Current versus Input Voltage

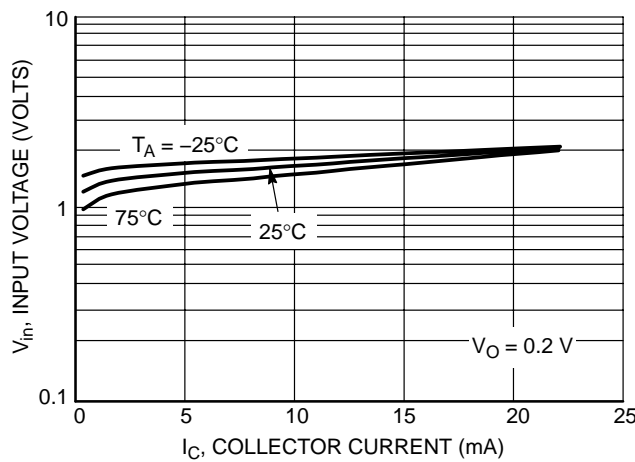

Figure 75. Input Voltage versus Output Current

LMUN5311DW1T1G Series S-LMUN5311DW1T1G Series

TYPICAL ELECTRICAL CHARACTERISTICS — LMUN5311DW1T1G PNP TRANSISTOR

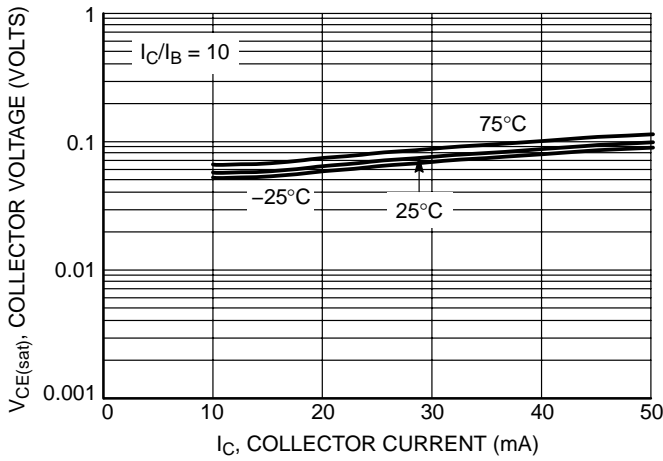

Figure 76.  $V_{CE(sat)}$  versus  $I_C$

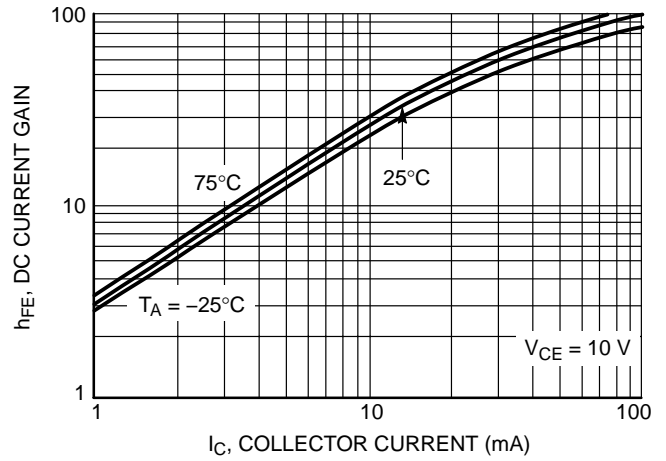

Figure 77. DC Current Gain

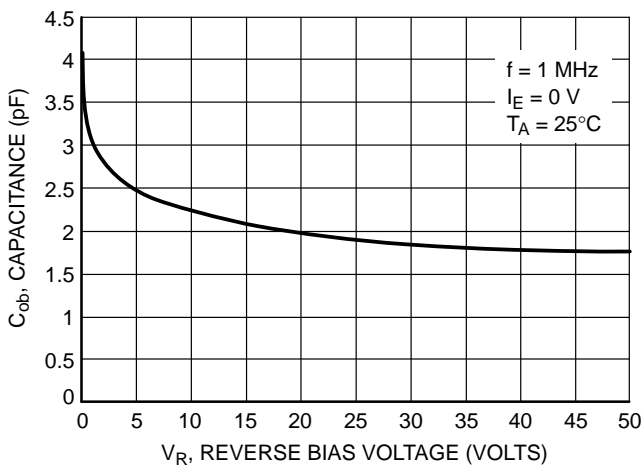

Figure 78. Output Capacitance

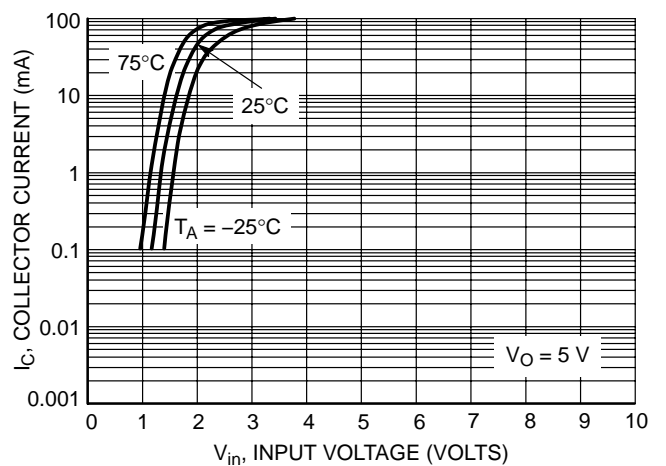

Figure 79. Output Current versus Input Voltage

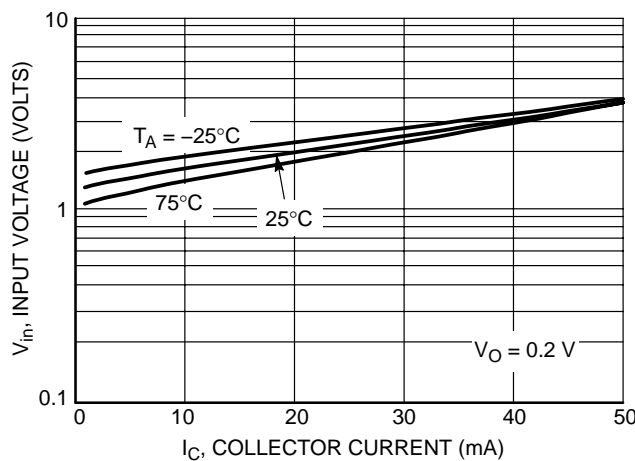

Figure 80. Input Voltage versus Output Current

LMUN5311DW1T1G Series S-LMUN5311DW1T1G Series

TYPICAL ELECTRICAL CHARACTERISTICS — LMUN5332DW1T1G NPN TRANSISTOR

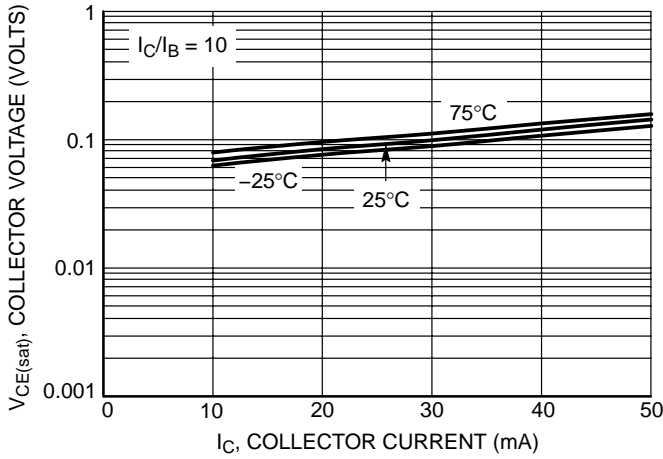

Figure 81.  $V_{CE(sat)}$  versus  $I_C$

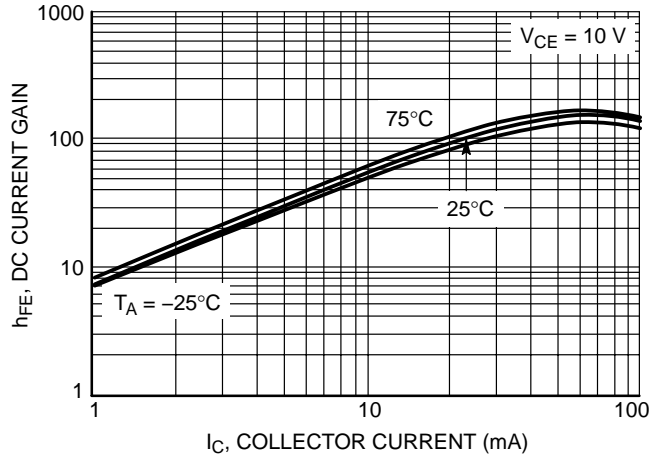

Figure 82. DC Current Gain

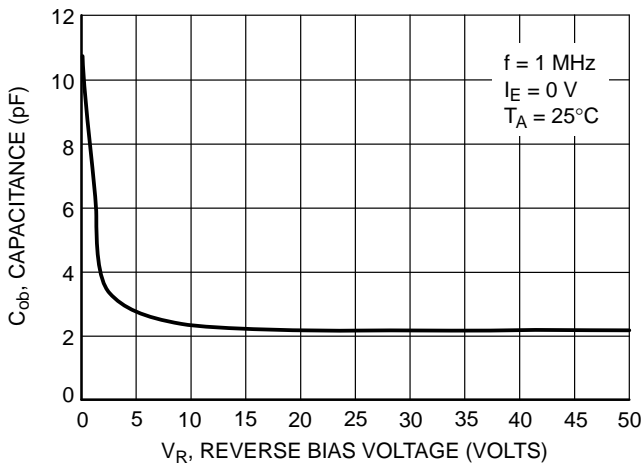

Figure 83. Output Capacitance

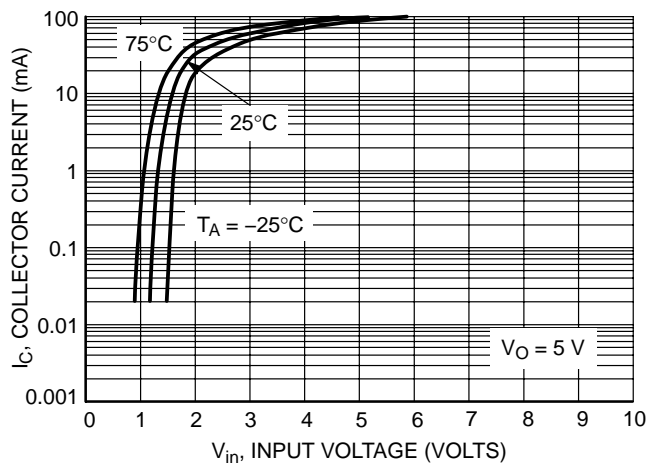

Figure 84. Output Current versus Input Voltage

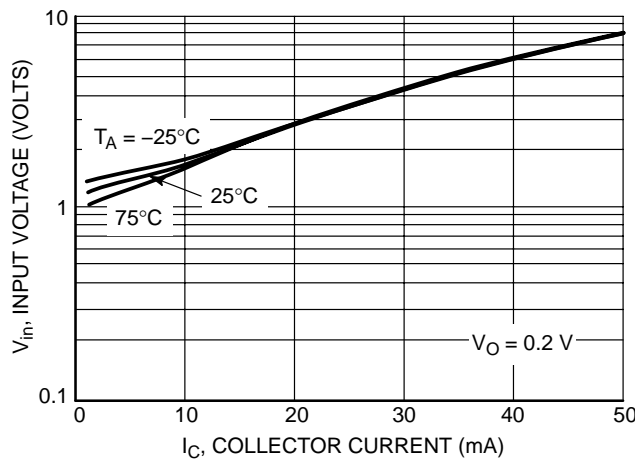

Figure 85. Input Voltage versus Output Current

LMUN5311DW1T1G Series S-LMUN5311DW1T1G Series

TYPICAL ELECTRICAL CHARACTERISTICS — LMUN5332DW1T1G PNP TRANSISTOR

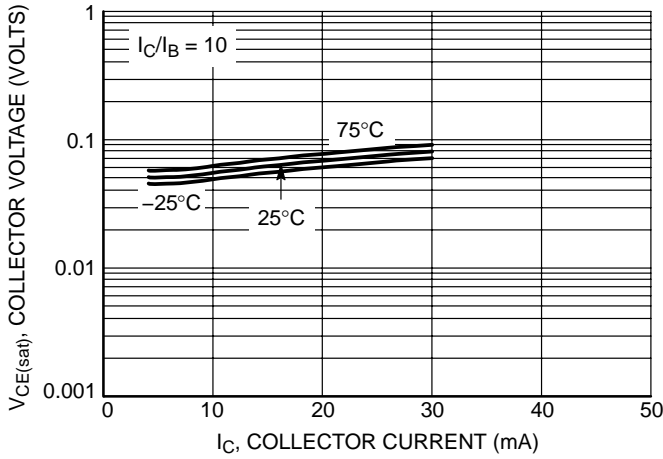

Figure 86.  $V_{CE(sat)}$  versus  $I_C$

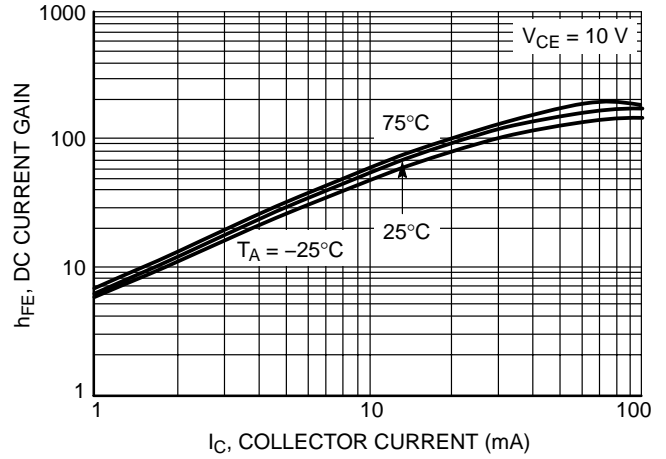

Figure 87. DC Current Gain

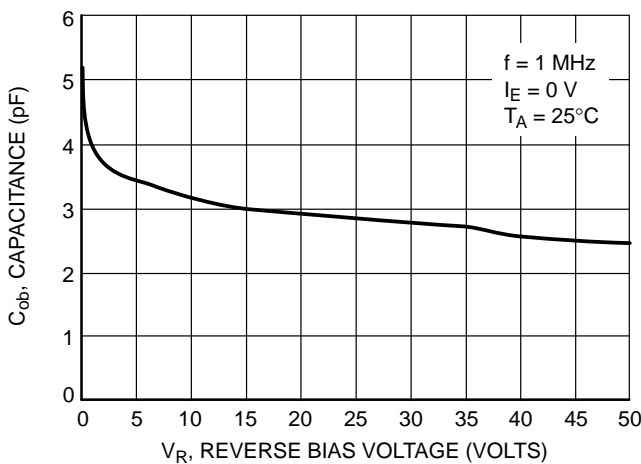

Figure 88. Output Capacitance

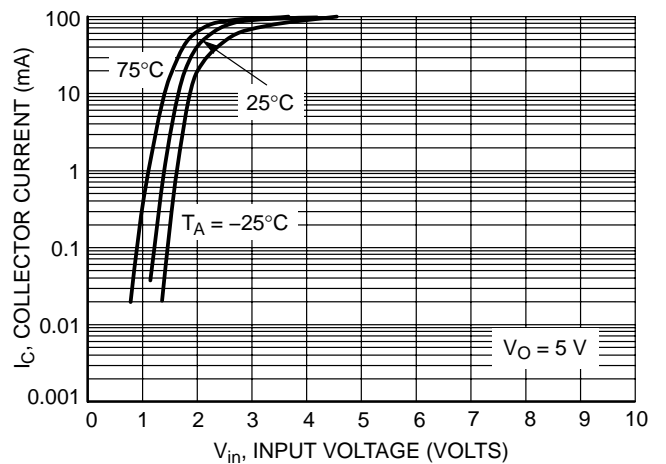

Figure 89. Output Current versus Input Voltage

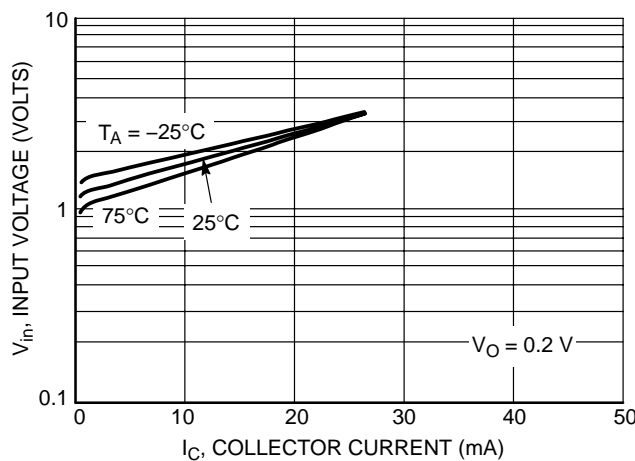

Figure 90. Input Voltage versus Output Current

LMUN5311DW1T1G Series S-LMUN5311DW1T1G Series

TYPICAL ELECTRICAL CHARACTERISTICS — LMUN5333DW1T1G NPN TRANSISTOR

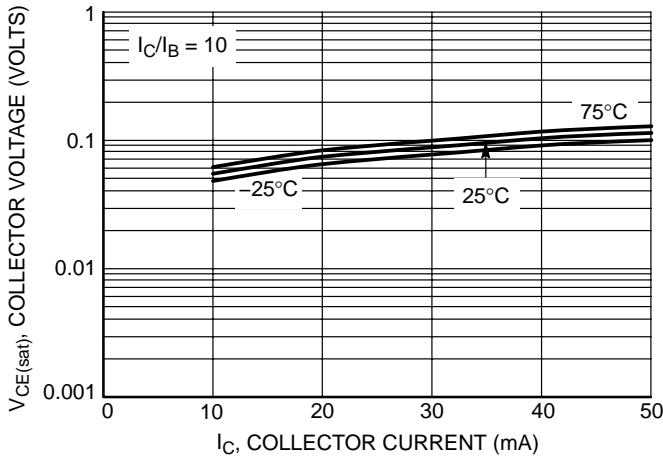

Figure 91.  $V_{CE(sat)}$  versus  $I_C$

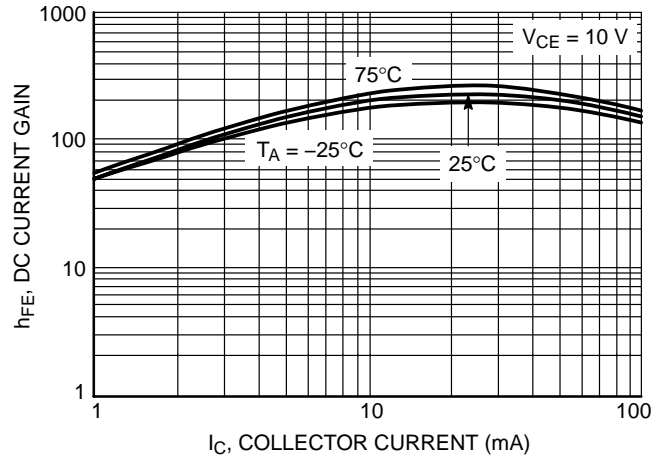

Figure 92. DC Current Gain

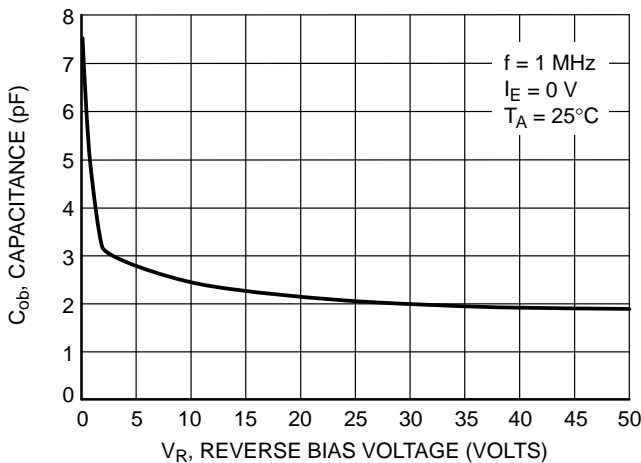

Figure 93. Output Capacitance

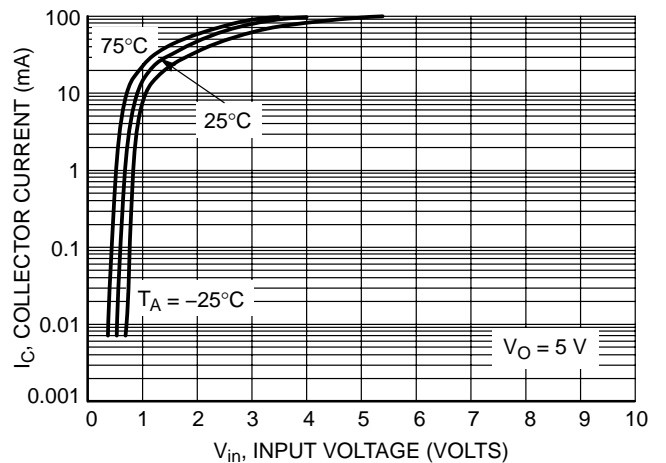

Figure 94. Output Current versus Input Voltage

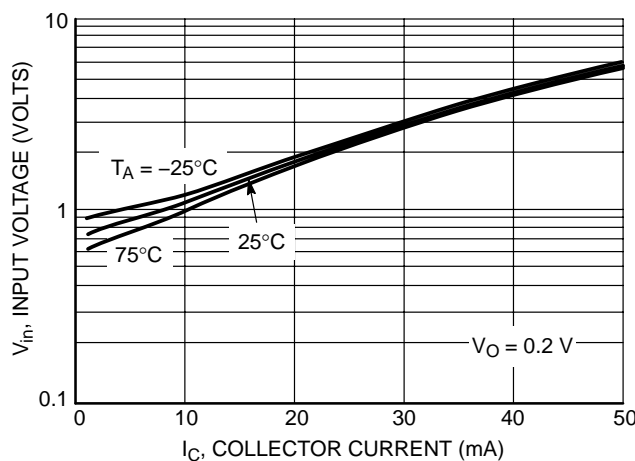

Figure 95. Input Voltage versus Output Current

LMUN5311DW1T1G Series S-LMUN5311DW1T1G Series

TYPICAL ELECTRICAL CHARACTERISTICS — LMUN5333DW1T1G PNP TRANSISTOR

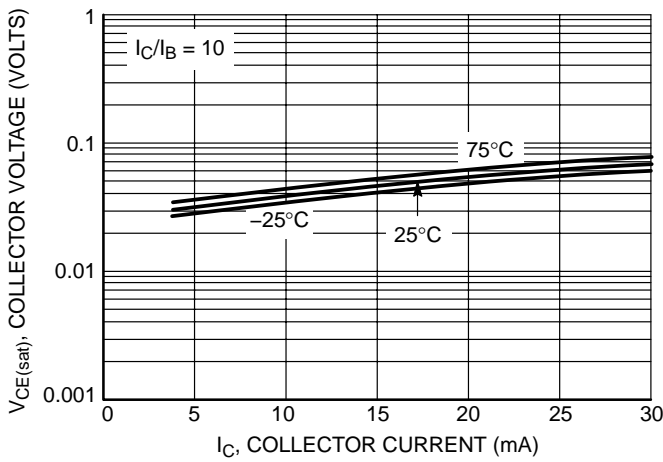

Figure 96.  $V_{CE(sat)}$  versus  $I_C$

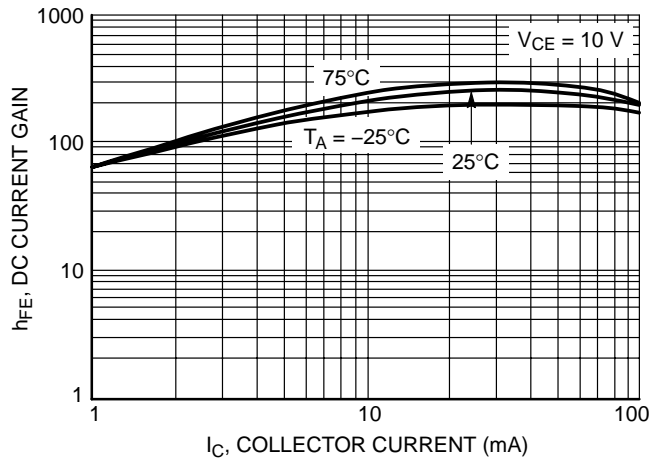

Figure 97. DC Current Gain

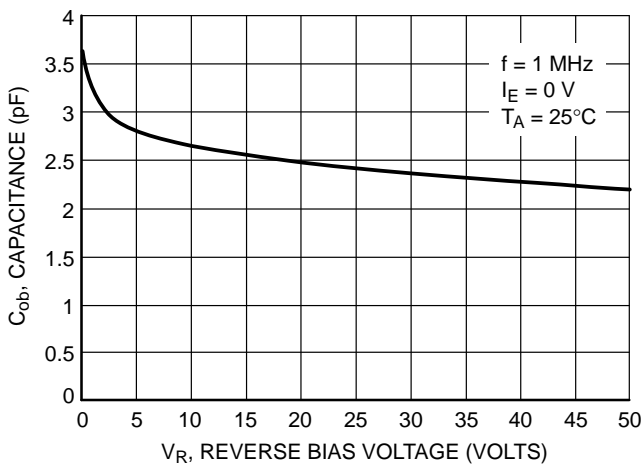

Figure 98. Output Capacitance

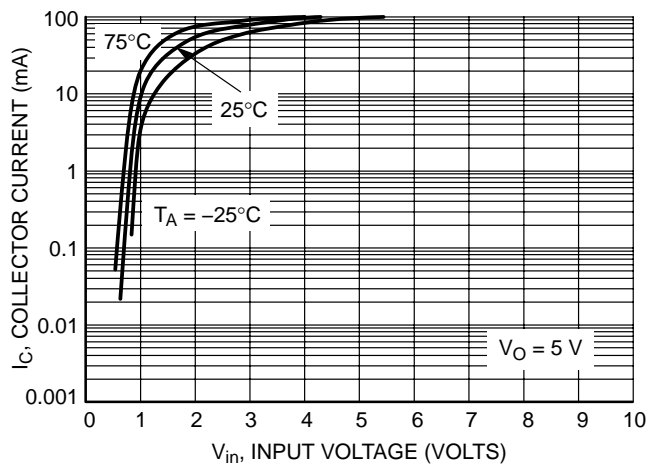

Figure 99. Output Current versus Input Voltage

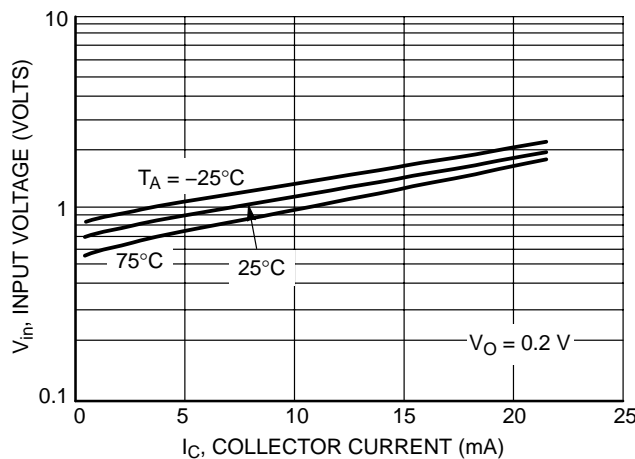

Figure 100. Input Voltage versus Output Current



LMUN5311DW1T1G Series S-LMUN5311DW1T1G Series

TYPICAL ELECTRICAL CHARACTERISTICS — LMUN5334DW1T1G NPN TRANSISTOR

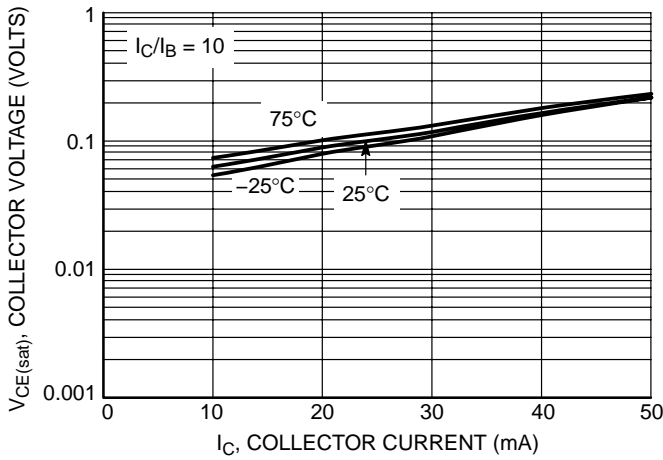

Figure 101.  $V_{CE(sat)}$  versus  $I_C$

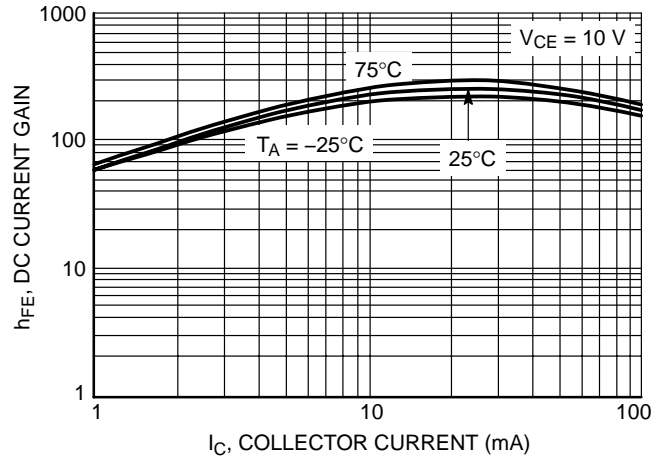

Figure 102. DC Current Gain

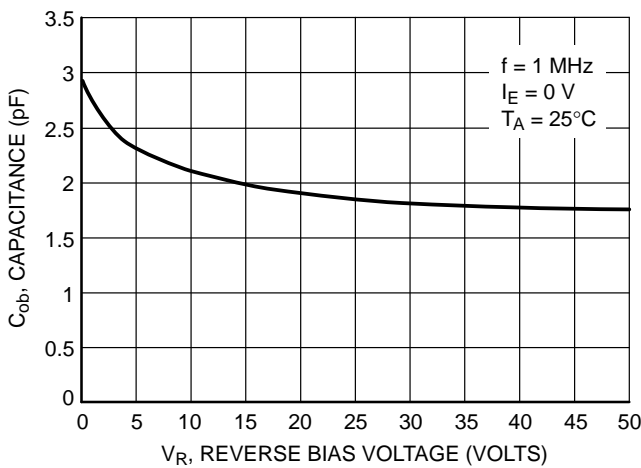

Figure 103. Output Capacitance

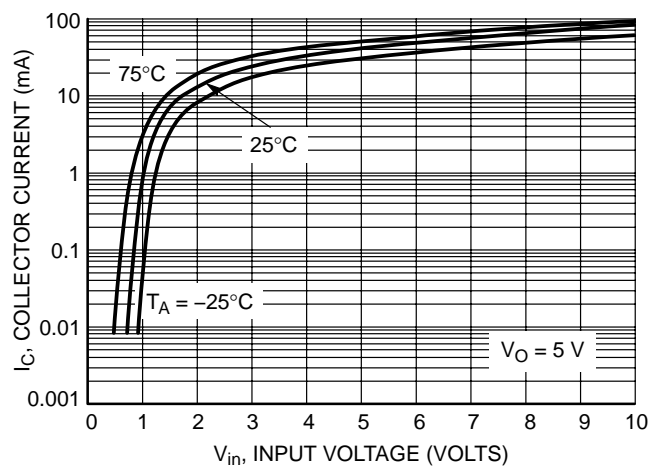

Figure 104. Output Current versus Input Voltage

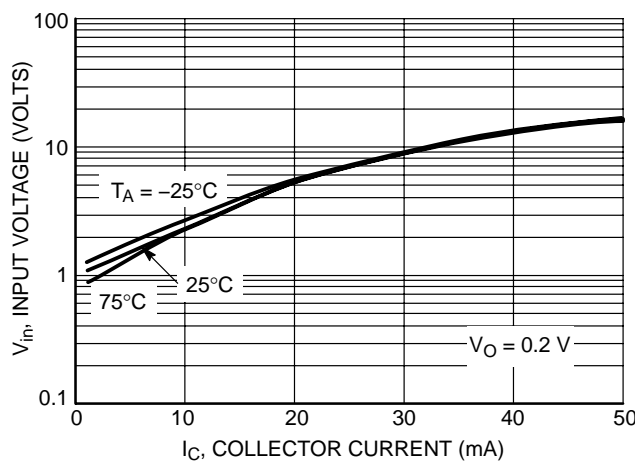

Figure 105. Input Voltage versus Output Current

LMUN5311DW1T1G Series S-LMUN5311DW1T1G Series

TYPICAL ELECTRICAL CHARACTERISTICS — LMUN5334DW1T1G PNP TRANSISTOR

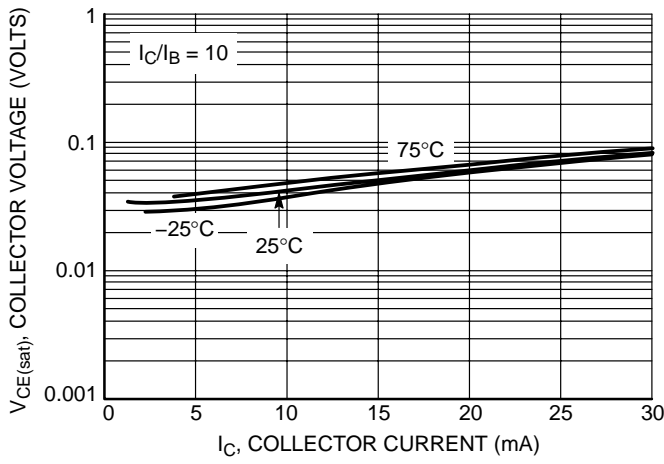

Figure 106.  $V_{CE(sat)}$  versus  $I_C$

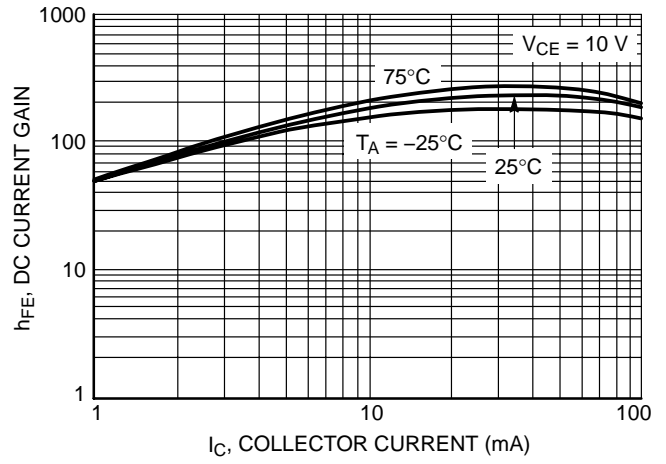

Figure 107. DC Current Gain

TYPICAL ELECTRICAL CHARACTERISTICS — LMUN5335DW1T1G NPN TRANSISTOR

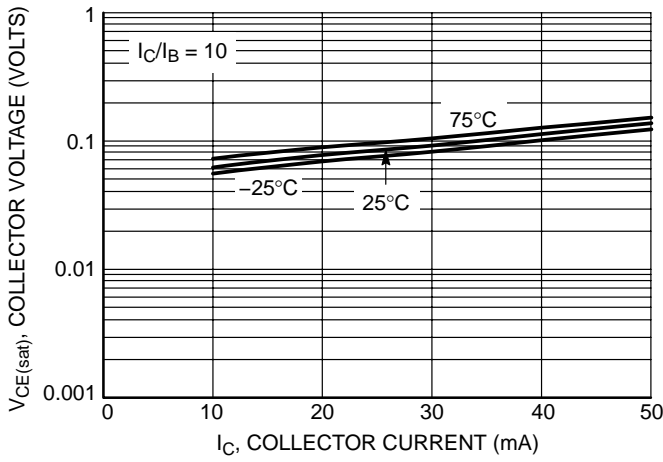

Figure 108.  $V_{CE(sat)}$  versus  $I_C$

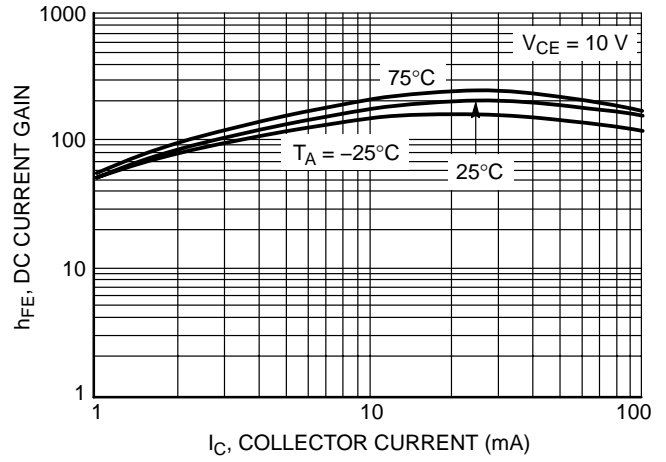

Figure 109. DC Current Gain

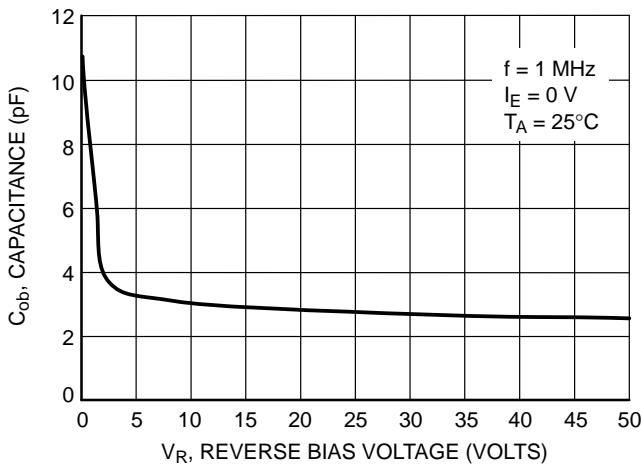

Figure 110. Output Capacitance

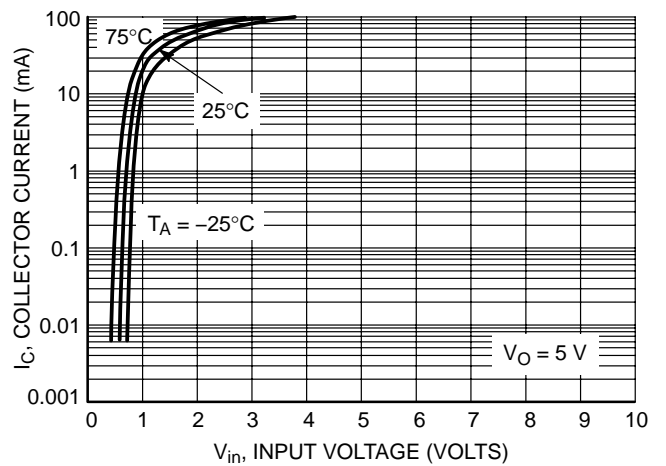

Figure 111. Output Current versus Input Voltage

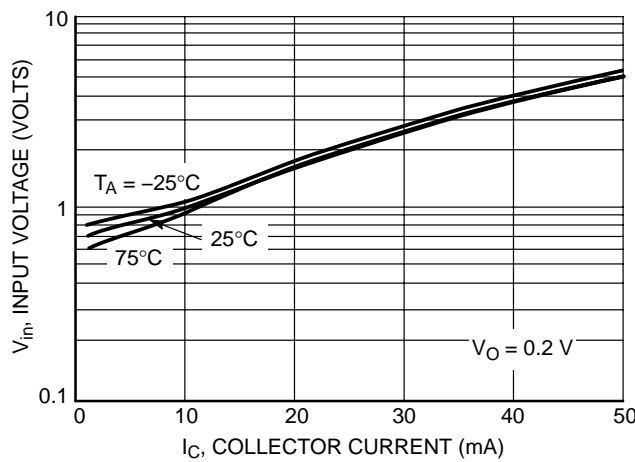

Figure 112. Input Voltage versus Output Current

LMUN5311DW1T1G Series S-LMUN5311DW1T1G Series

TYPICAL ELECTRICAL CHARACTERISTICS — LMUN5335DW1T1G PNP TRANSISTOR

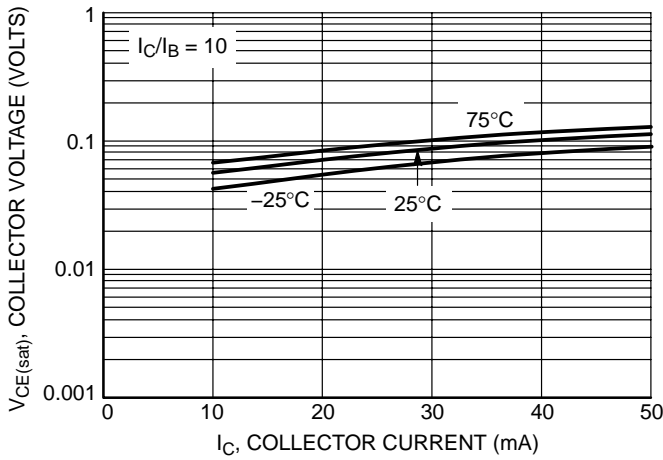

Figure 113.  $V_{CE(sat)}$  versus  $I_C$

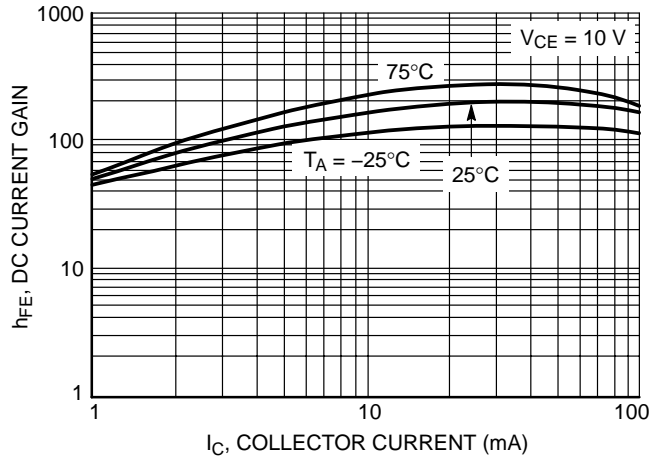

Figure 114. DC Current Gain

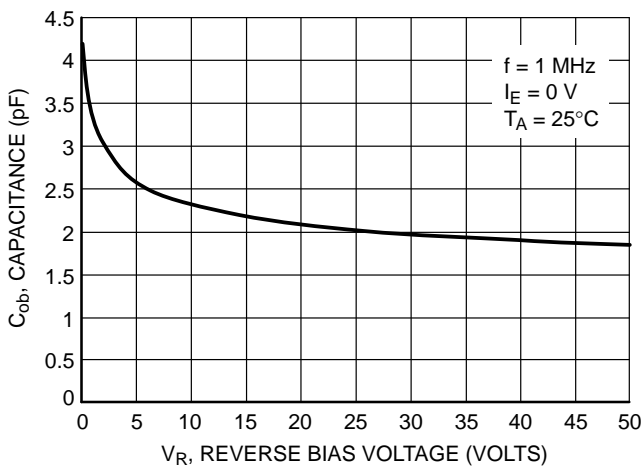

Figure 115. Output Capacitance

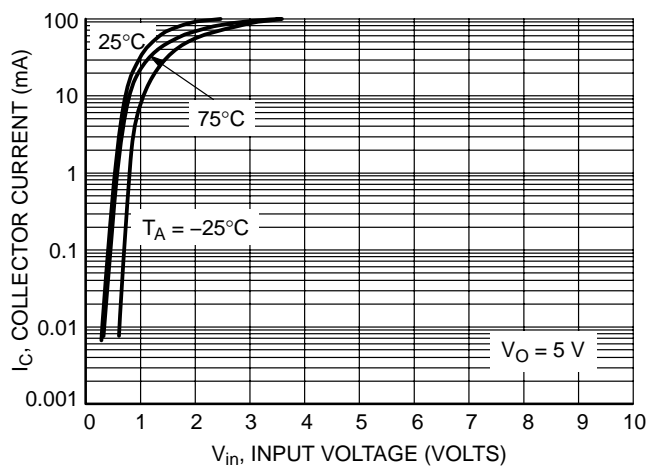

Figure 116. Output Current versus Input Voltage

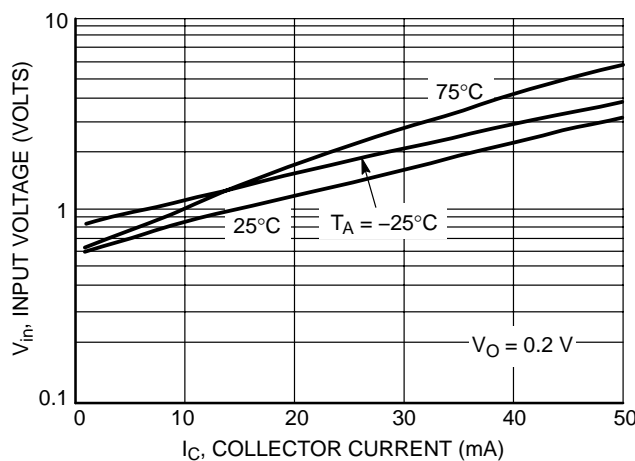
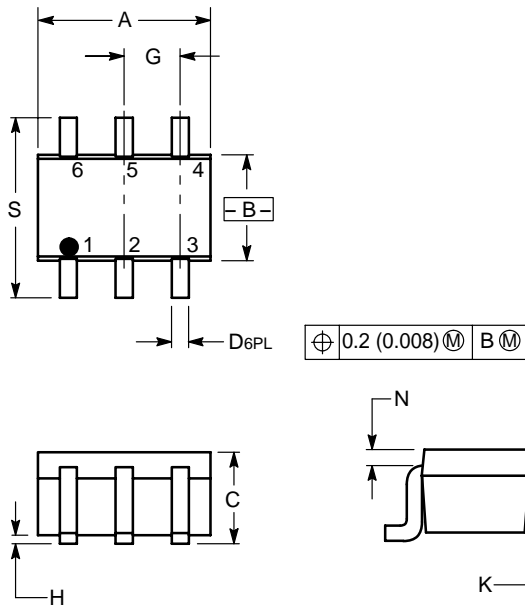

Figure 117. Input Voltage versus Output Current

LMUN5311DW1T1G Series S-LMUN5311DW1T1G Series

SC-88/SOT-363



NOTES:

1. DIMENSIONING AND TOLERANCING PER ANSI Y14.5M, 1982.
2. CONTROLLING DIMENSION: INCH.

DIM	INCHES		MILLIMETERS	
	MIN	MAX	MIN	MAX
A	0.071	0.087	1.80	2.20
B	0.045	0.053	1.15	1.35
C	0.031	0.043	0.80	1.10
D	0.004	0.012	0.10	0.30
G	0.026 BSC		0.65 BSC	
H	---	0.004	---	0.10
J	0.004	0.010	0.10	0.25
K	0.004	0.012	0.10	0.30
N	0.008 REF		0.20 REF	
S	0.079	0.087	2.00	2.20

- PIN 1. EMITTER 2  
 2. BASE 2  
 3. COLLECTOR 1  
 4. EMITTER 1  
 5. BASE 1  
 6. COLLECTOR 2

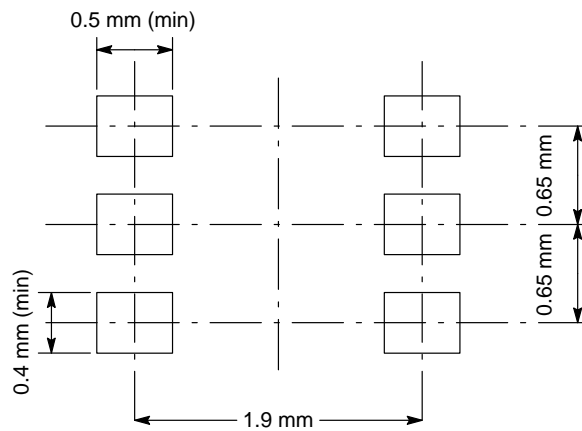

**DISCLAIMER**

- Before you use our Products, you are requested to carefully read this document and fully understand its contents. LRC shall not be in any way responsible or liable for failure, malfunction or accident arising from the use of any LRC's Products against warning, caution or note contained in this document.
- All information contained in this document is current as of the issuing date and subject to change without any prior notice. Before purchasing or using LRC's Products, please confirm the latest information with a LRC sales representative.

单击下面可查看定价，库存，交付和生命周期等信息

[>>LRC\(乐山无线电\)](#)