

S-SBR1560

Schottky Barrier Rectifiers

Reverse Voltage 60V Forward Current 15A

FEATURES

- * Plastic package has Underwriters Laboratory Flammability Classification 94V-0
- * Low power loss, high efficiency
- * For use in low voltage high frequency inverters, free wheeling, and polarity protection applications
- * Guardring for over voltage protection
- * High temperature soldering guaranteed: 260°C/10 seconds at terminals
- * S- Prefix for Automotive and Other Applications Requiring Unique Site and Control Change Requirements; AEC-Q101 Qualified and PPAP Capable.

Mechanical Data

Case: JEDEC TO-277A,
molded plastic over SKY body
Terminals: Plated leads, solderable per MIL-STD-750, Method 2026
Mounting Position: Any
Weight: 0.108 g
Handling precaution: None

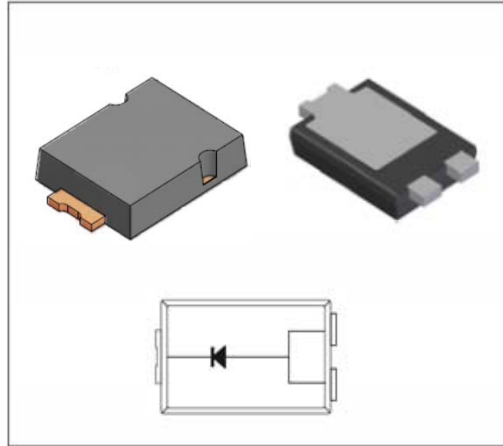

We declare that the material of product is Halogen free (green epoxy compound)

1. Electrical Characteristic

Maximum & Thermal Characteristics Ratings at 25°C ambient temperature unless otherwise specified.

Parameter Symbol	symbol	S-SBR1560	Unit
device marking code		S156	
Maximum repetitive peak reverse voltage	V_{RRM}	60	V
Maximum RMS voltage	V_{RMS}	42	V
Maximum DC blocking voltage	V_{DC}	60	V
Maximum average forward rectified current at $T_c = 65^\circ\text{C}$	$I_{F(AV)}$	15.0	A
Peak forward surge current 8.3ms single half sine-wave superimposed on rated load (JEDEC Method)	I_{FSM}	300	A
Typical thermal resistance (Note 1)	$R_{\theta JL}$	3	$^\circ\text{C/W}$
	$R_{\theta JC}$	8	
	$R_{\theta JA}$	60	
Typical thermal resistance (Note 3)	$R_{\theta JA}$	135	$^\circ\text{C/W}$
Operating junction temperature range	T_J	-55 to +150	$^\circ\text{C}$
Storage temperature range	T_{STG}	-55 to +150	$^\circ\text{C}$

Electrical Characteristics Ratings at 25°C ambient temperature unless otherwise specified.

Parameter Symbol	symbol	S-SBR1560	Unit
Maximum instantaneous forward voltage at 15A at 25°C	V_F	0.70	V
Maximum DC reverse current $T_j = 25^\circ\text{C}$ at rated DC blocking voltage $T_j = 125^\circ\text{C}$ (note2)	IR	0.2	mA
		20	
Typical junction capacitance at 4.0V, 1MHz	CJ	500	PF

NOTES:

1. Polyimide PCB, 2oz. Copper. Cathode pad dimensions 18.8mm x 14.4mm. Anode pad dimensions 5.6mm x 14.4mm.
2. Short duration pulse test used to minimize self-heating effect.
3. FR-4 PCB, 2oz. Copper.

S-SBR1560

2. Ratings and Characteristic Curves (TA = 25°C unless otherwise noted)

Fig. 1 - Forward Current Derating

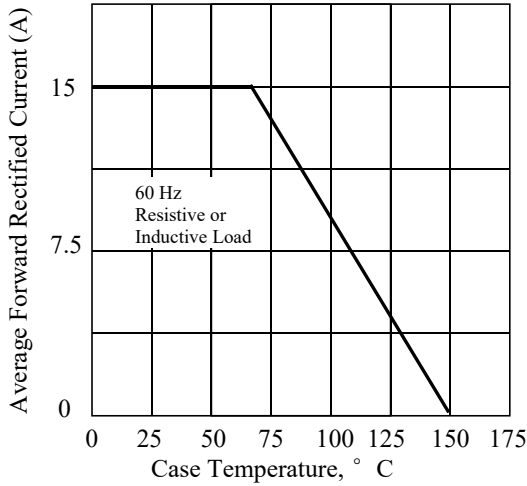

Fig. 2 - Maximum Non-repetitive Peak Forward Surge Current

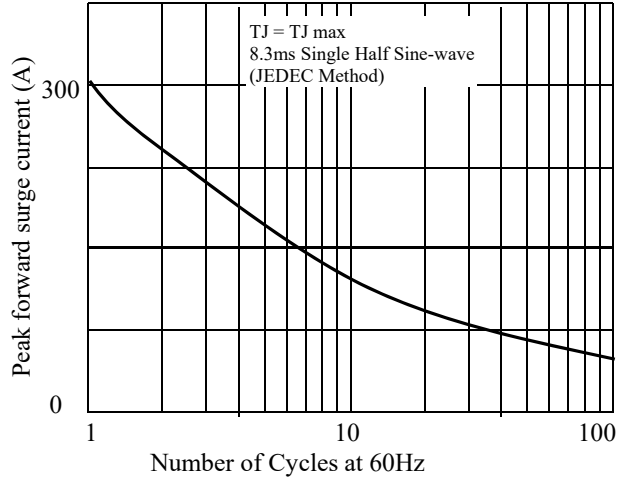

Fig 3. - Typical Instantaneous Forward Characteristics

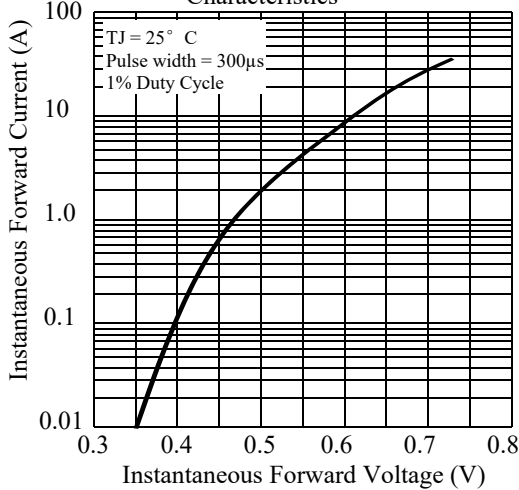

Fig 4. - Typical Reverse Characteristics

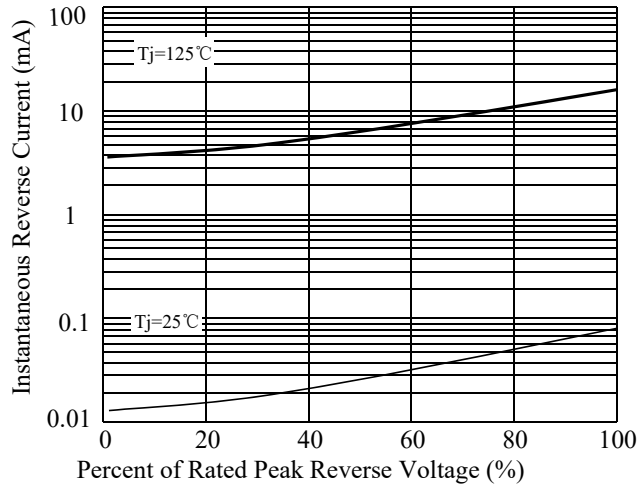

Fig 5. - typical transient thermal impedance (Note 3)

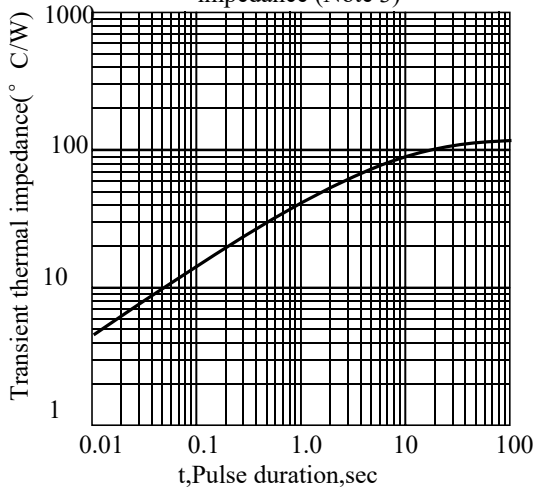
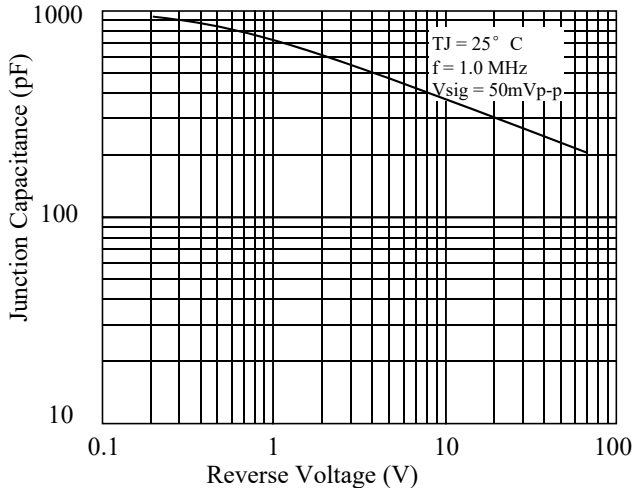

Fig 6. - Typical Junction Capacitance



S-SBR1560

3. dimension:

TO-277A

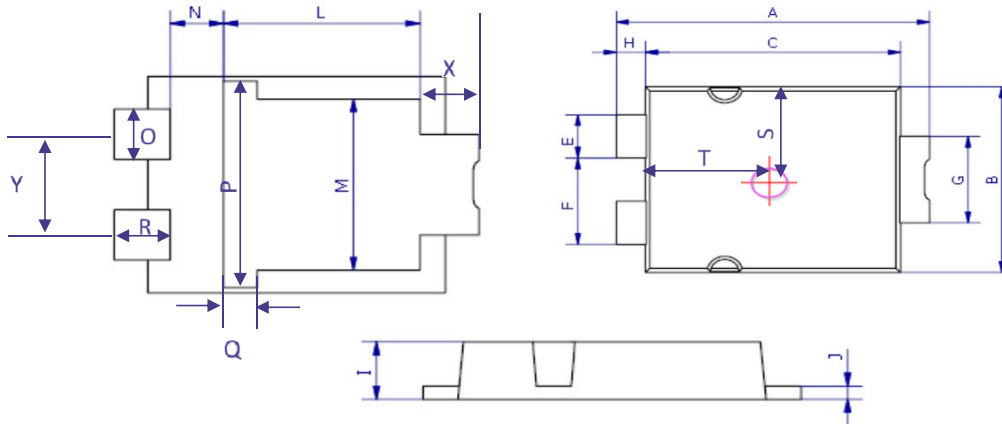

DIM	MILLIMETERS		INCHES		DIM	MILLIMETERS		INCHES	
	MIN	MAX	MIN	MAX		MIN	MAX	MIN	MAX
A	6.3	6.7	0.248	0.264	X	0.9	1.2	0.35	0.047
B	4.1	4.5	0.161	0.177	Y	1.9	2.1	0.075	0.083
C	5.1	5.5	0.201	0.217					
E	0.9	1.1	0.035	0.043					
F	1.9	2.1	0.075	0.083					
G	1.9	2.1	0.075	0.083					
H	0.50	0.70	0.020	0.028					
I	1.00	1.20	0.039	0.047					
J	0.15	0.35	0.006	0.014					
L	3.30	3.70	0.130	0.146					
M	3.20	3.60	0.126	0.142					
N	0.80	1.10	0.031	0.043					
O	0.90	1.10	0.035	0.043					
P	3.90	4.30	0.154	0.169					
Q	0.50	0.80	0.020	0.031					
R	0.85	1.15	0.033	0.045					
S	2.00	2.30	0.079	0.091					
T	2.50	2.80	0.098	0.110					

Mounting PAD layout

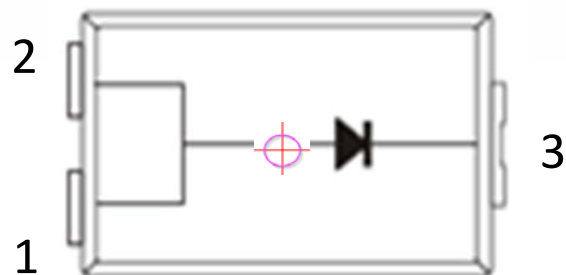
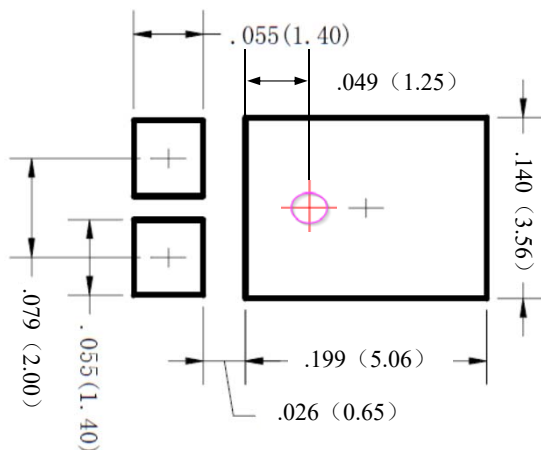

- 1: Anode
- 2: Anode
- 3: Cathode

S-SBR1560

4. Update Record

版次	更新记录	更新作者	更新日期
1	第一版	谭志伟	2022-4-11
A	marking优化为S156	谭志伟	2022-9-19

单击下面可查看定价，库存，交付和生命周期等信息

[>>LRC\(乐山无线电\)](#)