

HER301G thru HER308G

1. FEATURES

- * Plastic package has Underwriters Laboratories Flammability Classification 94V-0
- * Ideally suited for use in very high frequency switching power supplies, inverters and as free wheeling diodes
- * Ultrafast recovery time for high efficiency
- * Excellent high temperature switching
- * Soft recovery characteristics
- * Cavity-free glass passivated junction
- * High temperature soldering guaranteed: 260°C/10 seconds, 0.375" (9.5mm) lead length, 5 lbs. (2.3kg) tension

2. Mechanical Data

Case: JEDEC DO-201AD, molded plastic over glass body

Terminals: Plated axial leads, solderable per MIL-STD-750, Method 2026

Polarity: Color band denotes cathode end

Mounting Position: Any

Weight: 0.04 oz., 1.10 g

Handling precaution: None

3. Electrical Characteristic

Maximum Ratings & Thermal Characteristics Ratings at 25°C ambient temperature unless otherwise specified.

Parameter Symbol	symbol	HER 301G	HER 302G	HER 303G	HER 304G	HER 305G	HER 306G	HER 307G	HER 308G	Unit	
Maximum repetitive peak reverse voltage	V_{RRM}	50	100	200	300	400	600	800	1000	V	
Maximum RMS voltage	V_{RMS}	35	70	140	210	280	420	560	700	V	
Maximum DC blocking voltage	V_{DC}	50	100	200	300	400	600	800	1000	V	
Maximum average forward rectified current 0.375" (9.5mm) lead length at $T_A = 55^\circ\text{C}$	$I_{F(AV)}$	3.0								A	
Peak forward surge current 8.3ms single half sine-wave superimposed on rated load (JEDEC Method)	I_{FSM}	150					125				A
Maximum full load reverse current, full cycle average, 0.375" (9.5mm) lead lengths at $T_A = 55^\circ\text{C}$	$I_{R(AV)}$	100								μA	
Typical thermal resistance (Note 2)	$R_{\theta JA}$	55								$^\circ\text{C/W}$	
Operating junction and storage temperature range	T_J, T_{STG}	-50 to +150								$^\circ\text{C}$	

Glass Passivated Junction High Efficiency Rectifiers

Reverse Voltage 50 to 1000V

Forward Current 3.0A

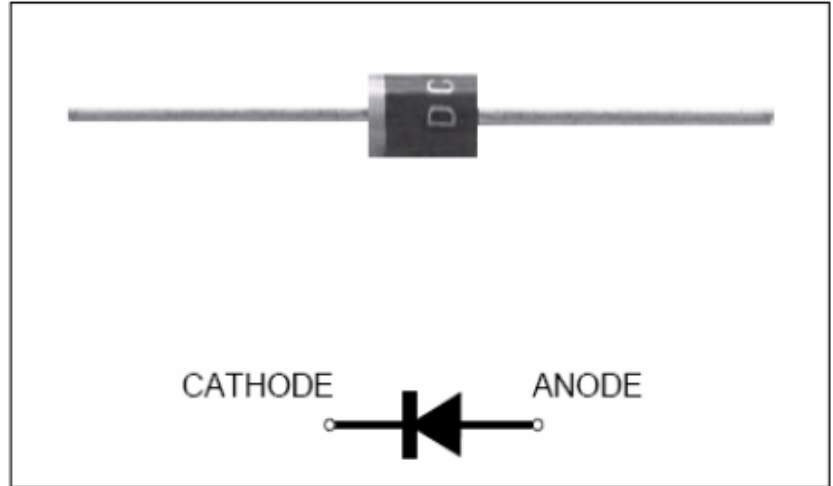

We declare that the material of product compliance with RoHS requirements.

Electrical Characteristics Ratings at 25°C ambient temperature unless otherwise specified.

Parameter Symbol	symbol	HER 301G	HER 302G	HER 303G	HER 304G	HER 305G	HER 306G	HER 307G	HER 308G	Unit	
Maximum instantaneous forward voltage at 3.0A	V_F	1.00		1.30		1.85				V	
Maximum DC reverse current $T_A = 25^\circ\text{C}$ at rated DC blocking voltage $T_A = 125^\circ\text{C}$	I_R	10				200					μA
Typical reverse recovery time (Note 1)	t_{rr}	50					75				ns
Typical junction capacitance at 4.0V, 1MHz	C_J	50					40				PF

NOTES:

1. $I_F = 0.5\text{A}$, $I_R = 1.0\text{A}$, $IRR = 0.25\text{A}$
2. Thermal resistance from junction to ambient at 0.375" (9.5mm) lead length, P.C.B. mounted

4. Ratings and Characteristic Curves (TA = 25°C unless otherwise noted)

FIG. 1-TEST CIRCUIT DIAGRAM AND REVERSE RECOVERY TIME CHARACTERISTIC

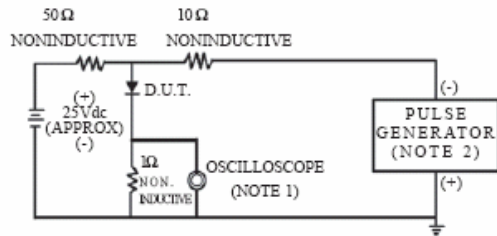

NOTES: 1. Rise Time=7ns max.
Input Impedance=1megohm, 22pF.
2. Rise Time=10ns max.
Source Impedance=50 ohms.

FIG. 2 - TYPICAL FORWARD CURRENT DERATING CURVE

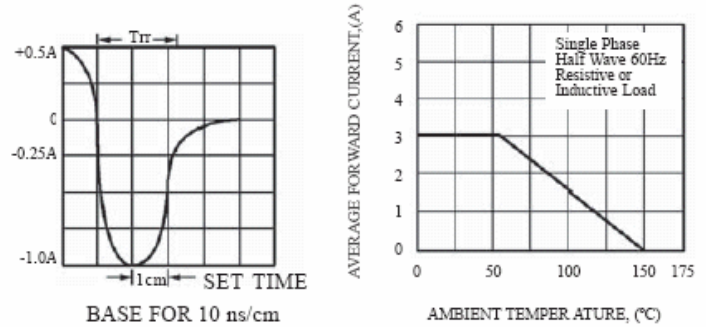

FIG. 3 - TYPICAL REVERSE CHARACTERISTICS

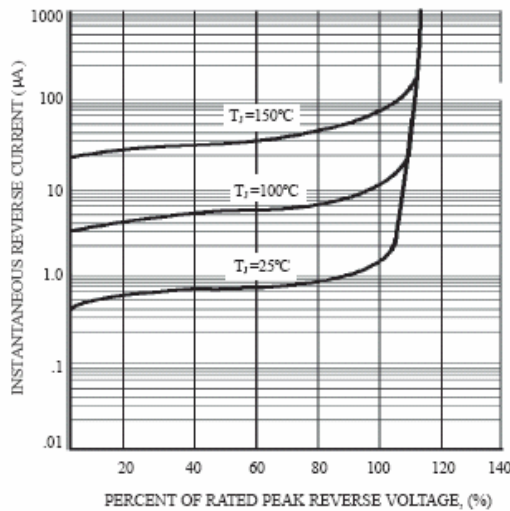

FIG. 4 - TYPICAL INSTANTANEOUS FORWARD CHARACTERISTICS

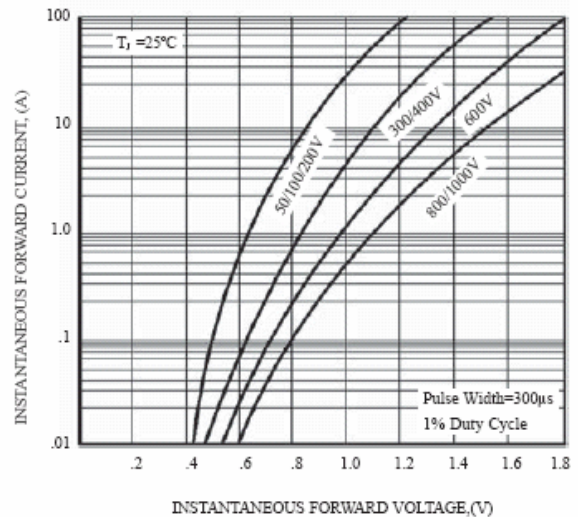

FIG. 5 - MAXIMUM NON-REPETITIVE FORWARD SURGE CURRENT

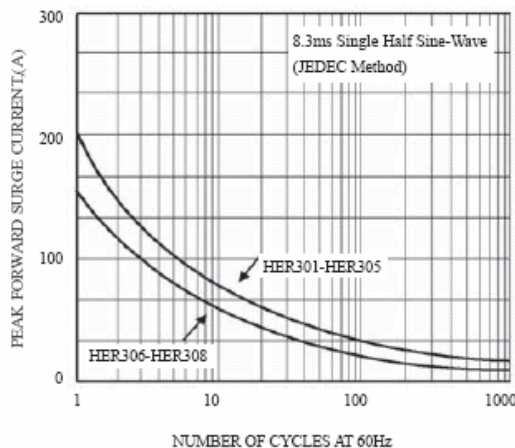
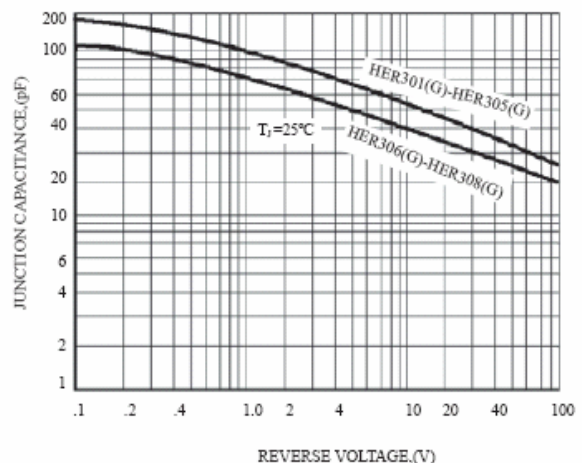
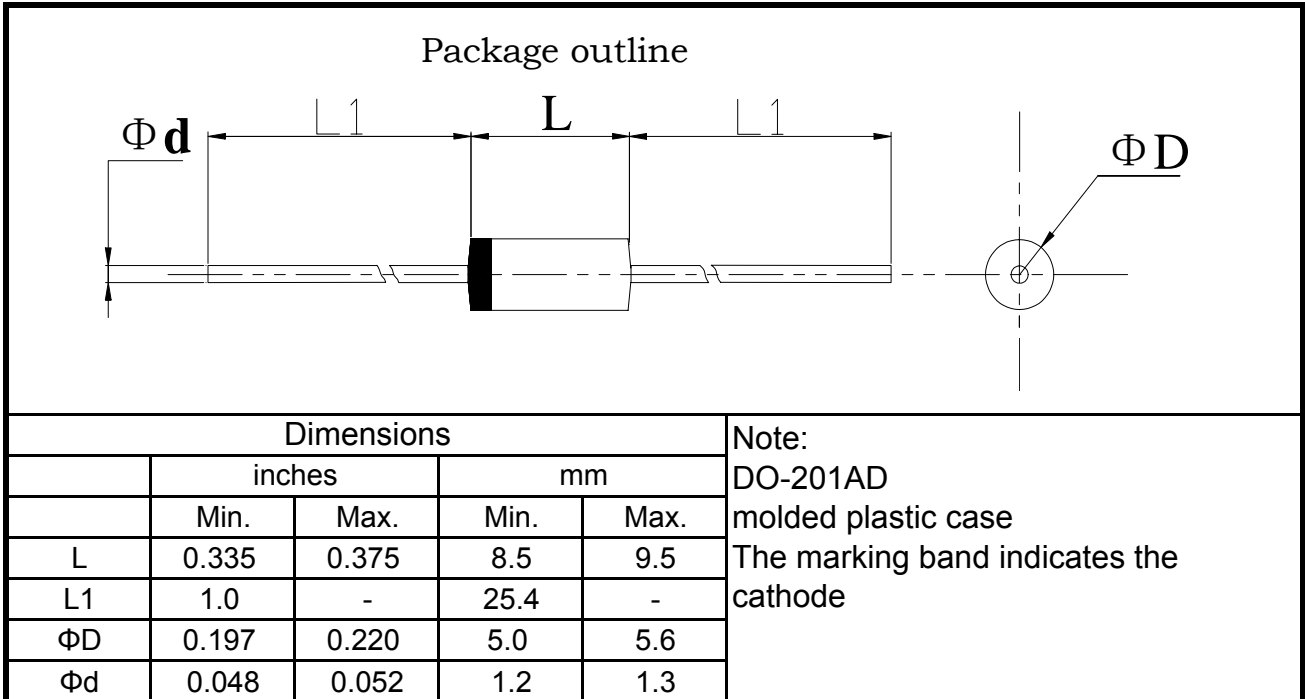

FIG. 6 - TYPICAL JUNCTION CAPACITANCE



5.Package Dimensions in inches and (millimeters)



Packing Of Plastic-Sealed Axial Lead Diodes

1. 卷盘/Reel Packing (52mm)

A: 卷盘规格/Reel spec.

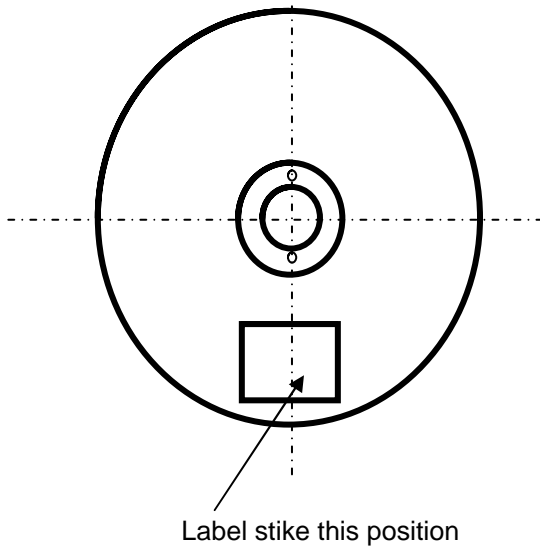

Unit:mm

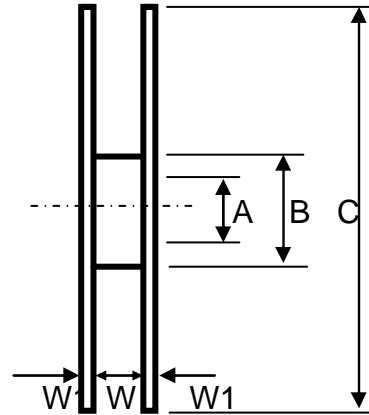

Item	Symbol	Dimension
Dimeter	A	76.4±0.1
	B	82.5±0.2
	C	330±0.5
Width	W	72±0.2
Thickness	W1	3±0.2

B: 外箱规格/Outer Box Specification

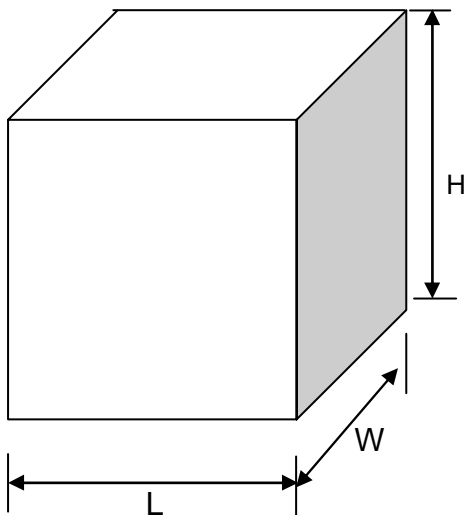

Item	Symbol	Dimension
Size	L	350±2
	W	350±2
	H	340±4

按以上包装方式: (As per the above spec)

	外型/Outside		
	DO-41 & A-405	DO-15	DO-201AD
Q'ty/Taping	5K	4K	1.4K
Q'ty/Packing Case	20K	16K	5.6K

2. 弹带盒装/Ammo Packing

Unit:mm

A: 弹带盒规格/Ammo Box Spec.



Item	Symbol	Dimension	Notes
Box's Size	L	260±2	52mm TYPE
	W	76±2	
	H	100±4	
	L	250±3	26mm TYPE
	W	45±3	
	H	95±5	

B: 外箱规格/Outer Box Specification

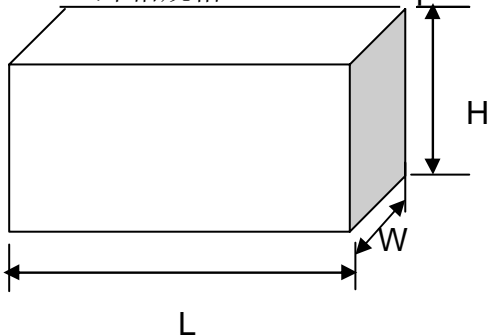

Item	Symbol	Dimension	Notes
Case's Size	L	430±2	52mm TYPE
	W	280±2	
	H	225±4	
	L	435±3	26mm TYPE
	W	280±3	
	H	295±5	

按以上包装方式: (As per the above spec)

	外型/Outside		
	A-405 & DO-41 & R-1	DO-15	DO-201AD
Q'ty/Taping	3K	2K	0.8K
Q'ty/Packing Case 26mm/TYPE	30K	20K	7.2K
Q'ty/Packing Case 52mm/TYPE	60K	40K	14.4K

3. 散装/Bulk Packing

A. 包装盒尺寸/Box Dimension

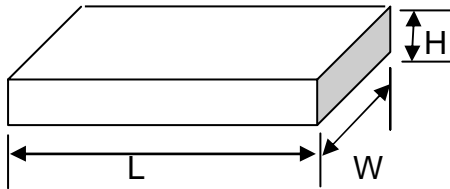

(DO-41&DO-15)

Item	Symbol	Dimension
Box's Size	L	200±2
	W	84±2
	H	21±2

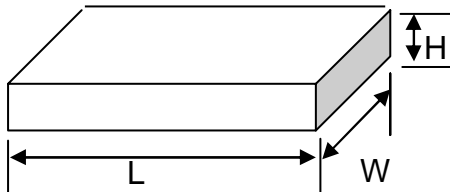

(DO-201AD)

Item	Symbol	Dimension
Box's Size	L	200±2
	W	84±2
	H	29±2

B: 外箱规格/Outer Box Specification

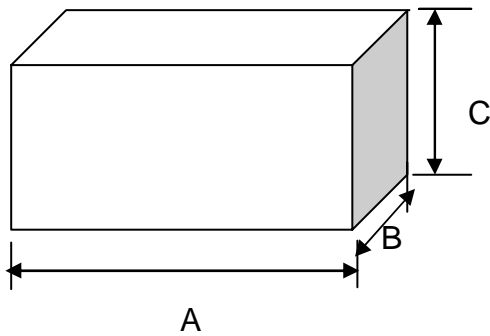

Item	Symbol	Dimension
Case's Size	L	465±2
	W	225±2
	H	260±4

按以上包装方式: (As per the above spec)

	外型/Outside		
	DO-41&A-405&R-1	DO-15	DO-201AD
Q'ty/Taping	1K	0.5K	0.3K
Q'ty/Packing Case	50K	25K	12K

4. 编带图形及规格/Taping Specification

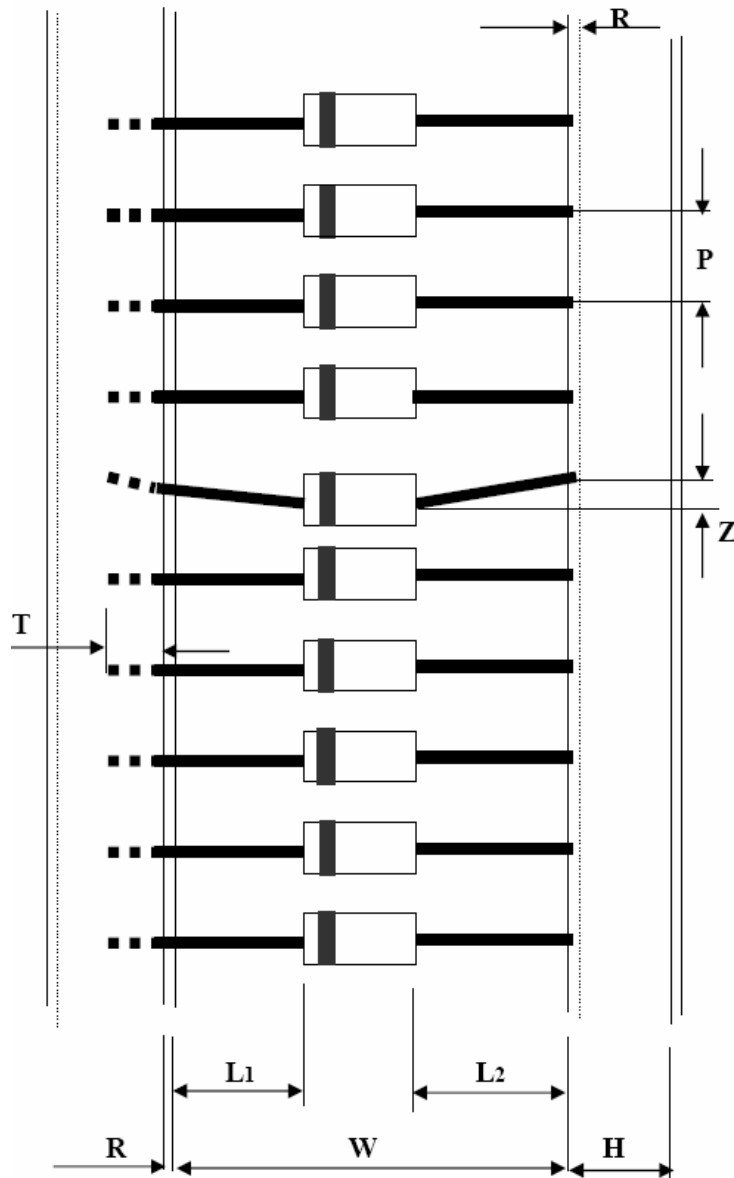

Unit:mm

尺寸代号	编带尺寸/Tape Dimension		
Dimension Code	26/tape	52/tape	52/tape#
W	26 0.0/+1.6	52 -1.0/+2.0	52 -1.0/+2.0
P	5±0.5	5±0.5	10±0.5
L1-L2	<1.0	<1.2	<1.2
H	6±1.0	6±1.0	6±1.0
Z	<1.2	<1.2	<1.2
R	<1.0	<1.0	<1.0
T	>3.2	>3.2	>3.2

注: 52编带# 为DO-201AD编带规格

Remark: 52 tape# is DO-201AD taping spec.

单击下面可查看定价，库存，交付和生命周期等信息

[>>LRC\(乐山无线电\)](#)