

SM540C

Surface Mount Schottky Barrier Rectifiers
Reverse Voltage 40V Forward Current 5.0A

1. FEATURES

- We declare that the material of product compliance with RoHS requirements and Halogen Free.
- Plastic package has Underwriters Laboratory Flammability Classification 94V-0.
- Low power loss,high efficiency.
- For use in low voltage high frequency inverters,free wheeling, and polarity protection applications.
- High temperature soldering guaranteed:260°C/10 seconds.
- Weight: 0.26g



2. DEVICE MARKING AND ORDERING INFORMATION

| Device | Marking | Shipping |
|--------|---------|----------------|
| SM540C | SM540C | 3000/Tape&Reel |

3. MAXIMUM RATINGS(Ta = 25°C)

| Parameter | Symbol | Limits | Unit |
|--|----------|-----------|------|
| Maximum repetitive peak reverse voltage | VRRM | 40 | V |
| Maximum RMS voltage | VRMS | 28 | V |
| Maximum DC blocking voltage | VDC | 40 | V |
| Maximum average forward rectified current at TC = 75°C | IF(AV) | 5 | A |
| Peak forward surge current 8.3ms single half sine-wave superimposed on rated load (JEDEC Method) | IFSM | 120 | A |
| Typical thermal resistance (Note 1) | RθJA | 80 | °C/W |
| | RθJC | 20 | |
| Operating junction and storage temperature range | TJ, TSTG | -50 ~+150 | °C |

4. ELECTRICAL CHARACTERISTICS (Ta= 25°C)

| Characteristic | Symbol | Min. | Typ. | Max. | Unit |
|--|--------|------|------|------|------|
| Maximum instantaneous forward voltage at 5.0A | VF | - | - | 0.55 | V |
| Maximum DC reverse current TA = 25°C at rated DC blocking voltage TJ = 125°C | IR | - | - | 0.5 | mA |
| | | - | - | 10 | |
| Typical junction capacitance at 4.0V, 1MHz | CJ | - | 250 | - | PF |

1. Mounted on 0.31 x 0.31" (8.0 x 8.0mm) copper pads to each terminal

5. ELECTRICAL CHARACTERISTICS CURVES

Fig. 1 - Forward Current Derating Curve

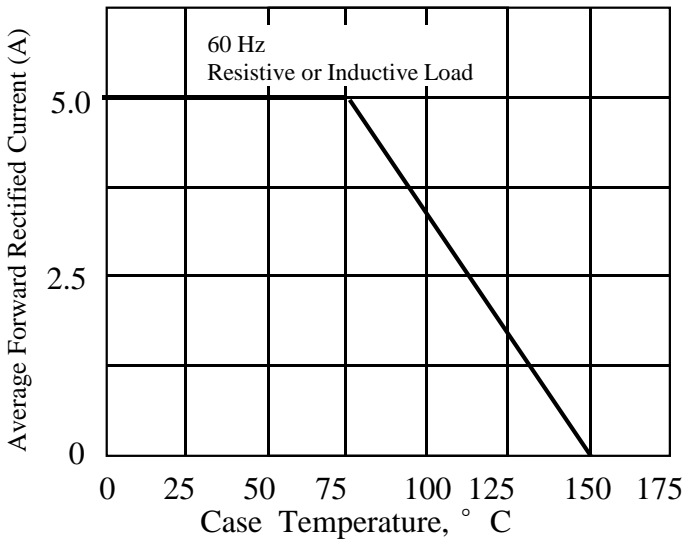

Fig. 2 - Maximum Non-repetitive Peak Forward Surge Current

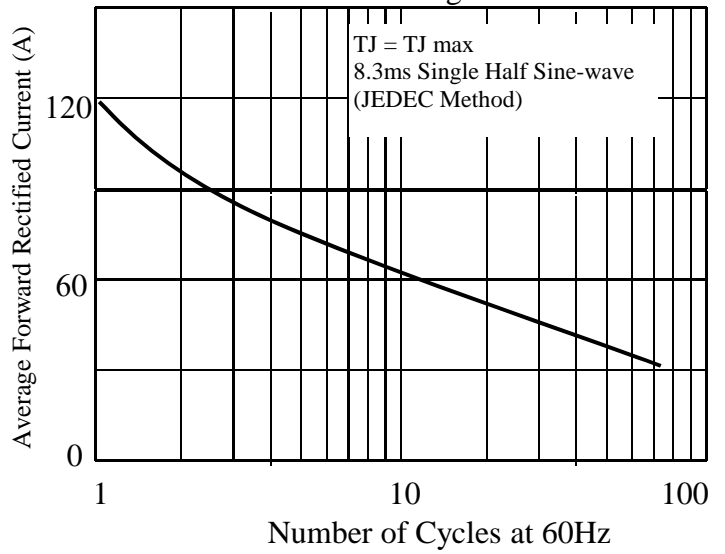

Fig. 3 - Typical Instantaneous Forward Characteristics

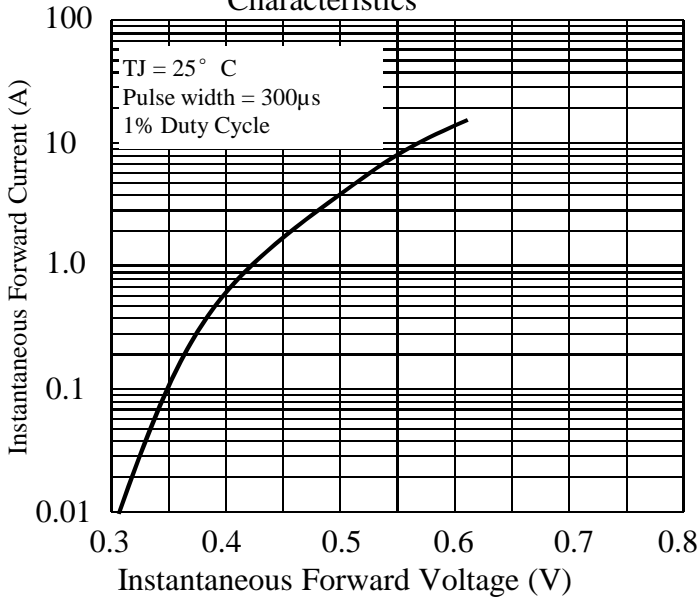

Fig. 4 - Typical Reverse Characteristics

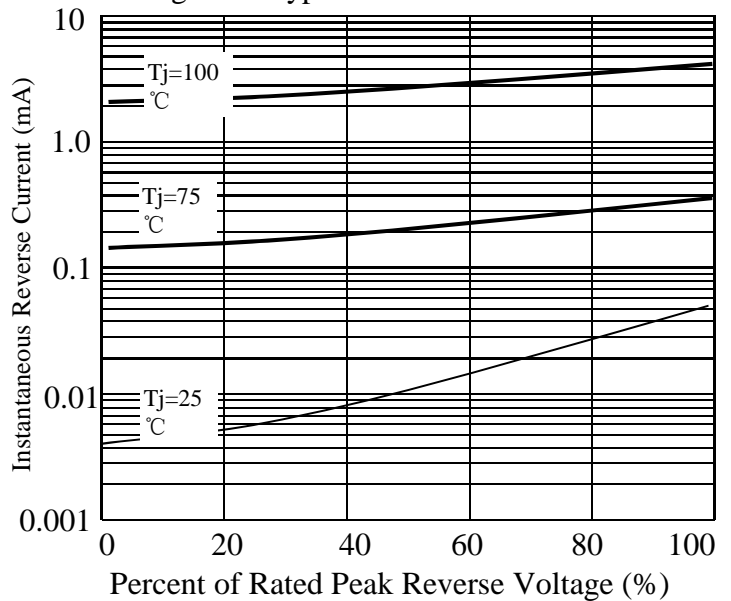
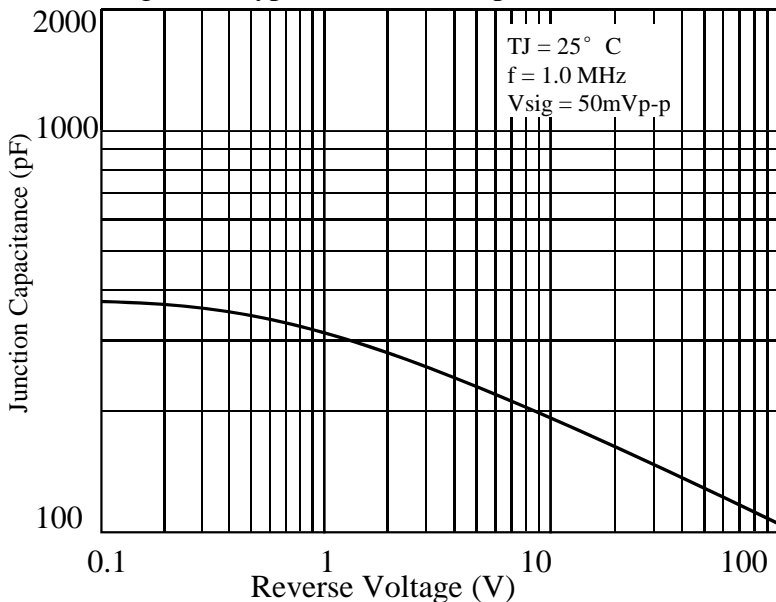
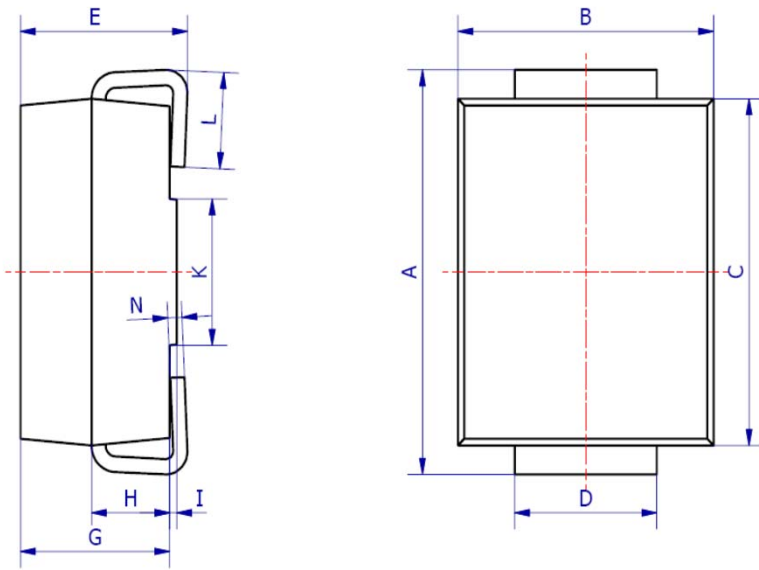

Fig. 5 - Typical Junction Capacitance



6. OUTLINE AND DIMENSIONS



| SMC | | | |
|----------------------|------|------|------|
| DIM | Min | Max | Typ. |
| A | 7.70 | 8.30 | 8.00 |
| B | 5.85 | 6.25 | 6.05 |
| C | 6.65 | 7.05 | 6.85 |
| D | 2.80 | 3.20 | 3.00 |
| E | 2.45 | 2.85 | 2.65 |
| G | 2.10 | 2.50 | 2.30 |
| H | 1.00 | 1.40 | 1.20 |
| I | 0.05 | 0.15 | 0.10 |
| K | 4.30 | 4.70 | 4.50 |
| L | 1.00 | 1.50 | 1.25 |
| N | 0.10 | 0.30 | 0.20 |
| All Dimensions in mm | | | |

7. SOLDERING FOOTPRINT

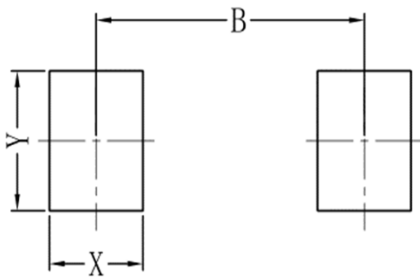

| SMC | |
|-----|------|
| DIM | (mm) |
| X | 1.60 |
| Y | 3.30 |
| B | 6.60 |

单击下面可查看定价，库存，交付和生命周期等信息

[>>LRC\(乐山无线电\)](#)