

LBTN560Z4TZHG

S-LBTN560Z4TZHG

60 V NPN transistor

1. FEATURES

- Low collector-emitter saturation voltage.
- High collector current capability.
- High collector current gain.
- High efficiency due to less heat generation.
- Smaller required Printed-Circuit Board (PCB) area.
- We declare that the material of product compliance with RoHS requirements and Halogen Free.
- S- prefix for automotive and other applications requiring unique site and control change requirements; AEC-Q101 qualified and PPAP capable.

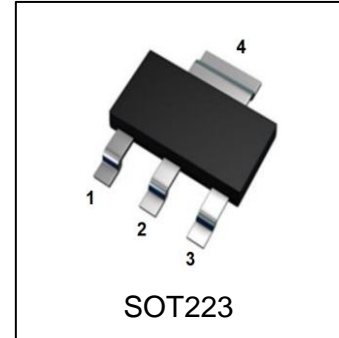

2. DEVICE MARKING AND ORDERING INFORMATION

Device	Marking	Shipping
LBTN560Z4TZHG	NB	1000/Tape&Reel

3. MAXIMUM RATINGS(Ta = 25°C)

Parameter	Symbol	Limits	Unit
Collector–Emitter Voltage	VCEO	60	V
Collector–Base Voltage	VCBO	60	V
Emitter–Base Voltage	VEBO	5	V
Collector Current — Continuous	IC	5.2	A
Peak Collector Current (tp ≤ 1 ms)	ICM	10.4	A
Junction and Storage temperature	TJ, Tstg	-55~+150	°C

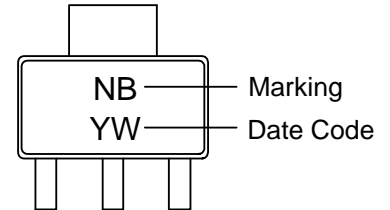
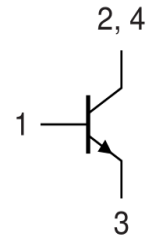

4. THERMAL CHARACTERISTICS

Parameter	Symbol	Limits	Unit
Total Device Dissipation, FR-4 Board (Note 1) @ TA = 25°C	PD	1	W
Thermal Resistance, Junction–to–Ambient(Note 1)	RθJA	125	°C/W
Thermal Resistance, Junction–to–Case	RθJC	30	°C/W

1. FR-4 = 30.0mm×25.0mm×1.6mm.

5. ELECTRICAL CHARACTERISTICS (Ta= 25°C)
OFF CHARACTERISTICS

Characteristic	Symbol	Min.	Typ.	Max.	Unit
Collector–Emitter Breakdown Voltage (IC = 1 mA, IB = 0)	VBR(CEO)	60	-	-	V
Collector–Base Breakdown Voltage (IC = 100 μA, IE = 0)	VBR(CBO)	60	-	-	V
Emitter–Base Breakdown Voltage (IE = 100 μA, IC = 0)	VBR(EBO)	5	-	-	V
Collector Cutoff Current (VCB = 60V, IE = 0 A)	ICBO	-	-	100	nA
(VCB = 60V, IE = 0 A, Tj = 150 °C)		-	-	50	μA
Emitter CutOff Current (VEB = 5 V, IC = 0 A)	IEBO	-	-	100	nA
Collector-Emitter cutoff Current (VCE= 60V, IB=0)	ICEO	-	-	10	μA

ON CHARACTERISTICS (Note 2)

DC Current Gain (VCE = 2 V, IC = 0.5 A)	HFE	300	520	-	
(VCE = 2 V, IC = 1 A)		300	500	-	
(VCE = 2 V, IC = 2 A)		250	470	-	
(VCE = 2 V, IC = 4 A)		150	250	-	
(VCE = 2 V, IC = 6 A)		80	120	-	
Collector–Emitter Saturation Voltage (IC = 0.5 A, IB = 50 mA)	VCE(sat)	-	25	35	mV
(IC = 1 A, IB = 50 mA)		-	50	70	
(IC = 1 A, IB = 10 mA)		-	85	120	
(IC = 2 A, IB = 40 mA)		-	105	150	
(IC = 4 A, IB = 200 mA)		-	155	220	
(IC = 4 A, IB = 400 mA)		-	145	210	
(IC = 4 A, IB = 80 mA)		-	205	305	
(IC = 5.2 A, IB = 260 mA)	-	200	280		
Base–Emitter Saturation Voltage (IC = 1 A, IB = 100 mA)	VBE(sat)	-	0.82	0.9	V
(IC = 4 A, IB = 400 mA)		-	0.94	1.05	
Base-Emitter Turn-On Voltage (VCE = 2 V, IC = 2 A)	VBE(on)	-	0.75	0.85	V

5. ELECTRICAL CHARACTERISTICS (Ta= 25°C)
SMALL-SIGNAL CHARACTERISTICS

Transitional Frequency (VCE = 10 V, IC = 100 mA, f = 100 MHz)	fT	-	130	-	MHz
Collector Capacitance (VCB = 10 V, IE = ie = 0 A, f = 1 MHz)	Cc	-	48	70	pF

SWITCHING CHARACTERISTICS

Delay time	(VCC = 12.5 V, IC = 3 A, IB(on) = 0.15 A, IB(off) = -0.15 A)	td	-	15	-	ns
Rise time		tr	-	95	-	
Turn-on time		ton	-	110	-	
Storage time		ts	-	360	-	
Fall time		tf	-	195	-	
Turn-off time		toff	-	555	-	

2. Pulse Test: Pulse Width $\leq 300 \mu\text{s}$, Duty Cycle $\leq 2.0\%$.

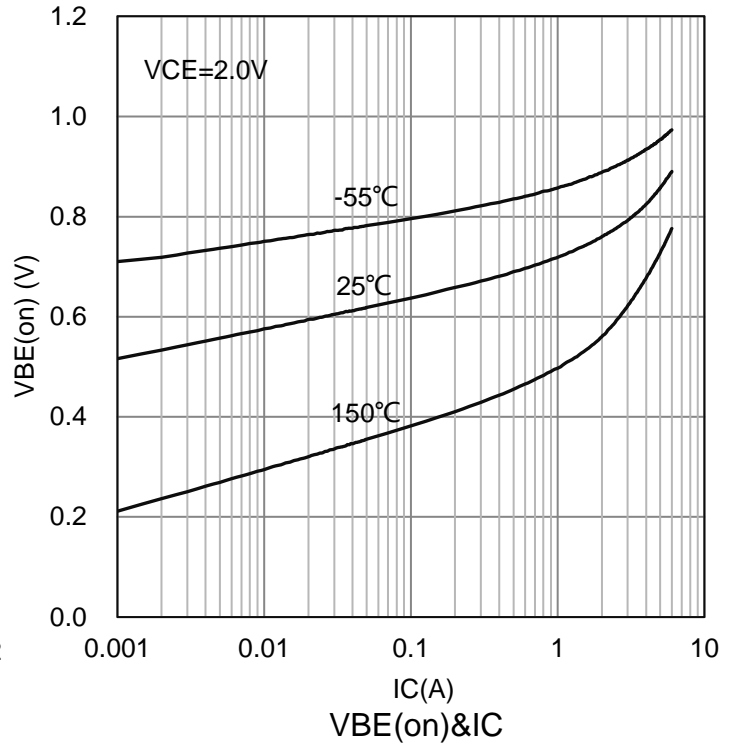
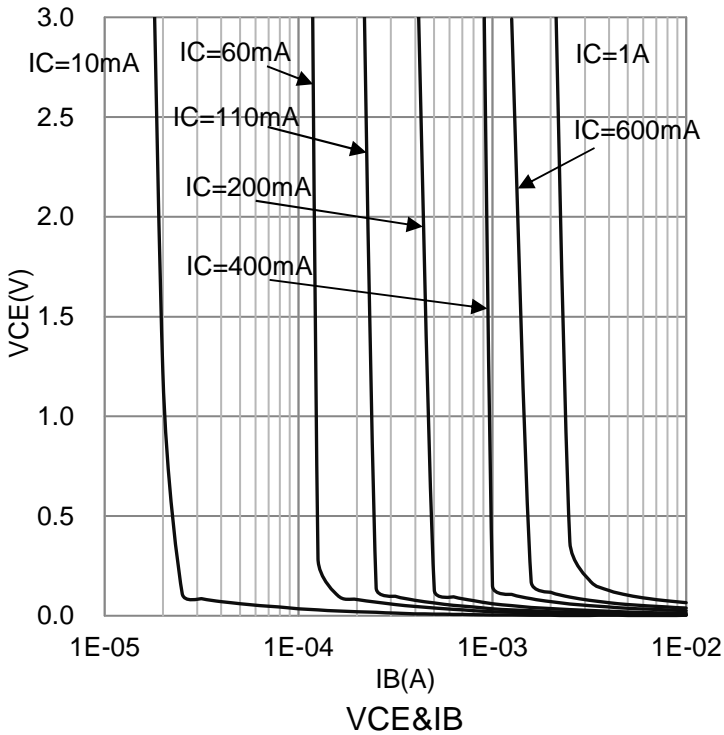
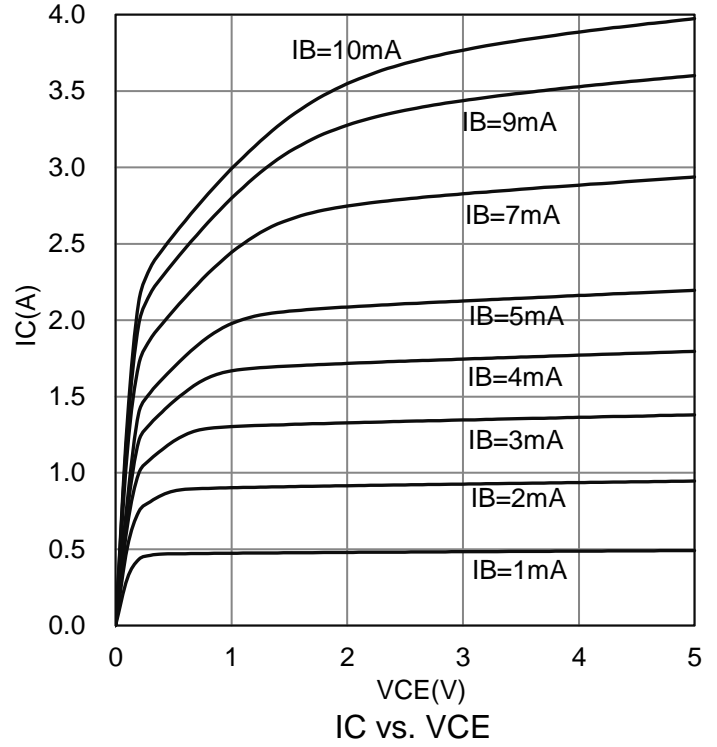
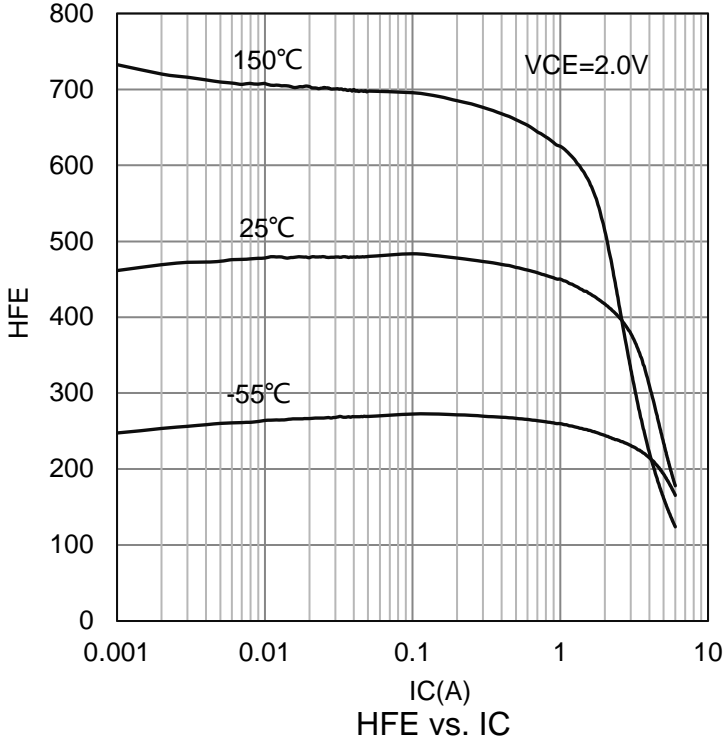
6.ELECTRICAL CHARACTERISTICS CURVES

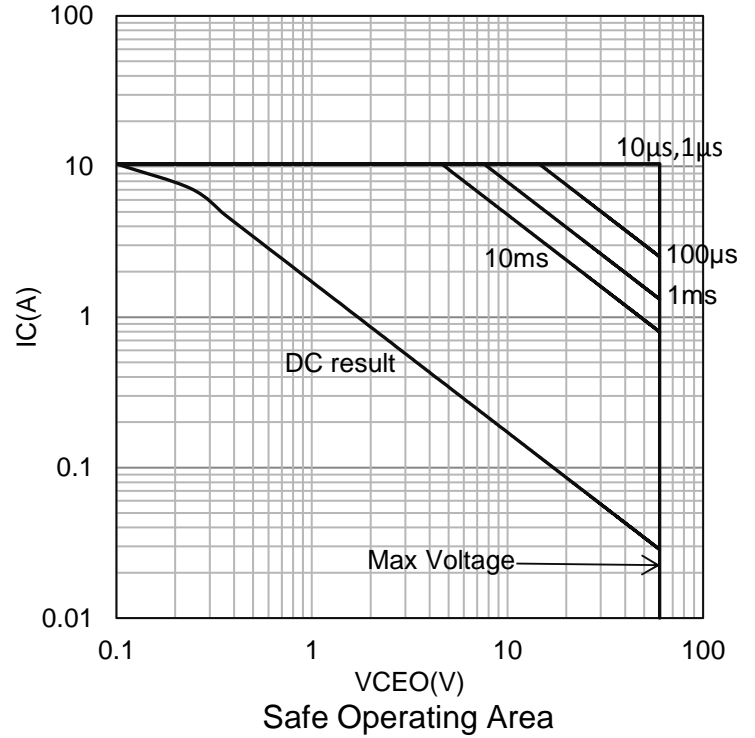
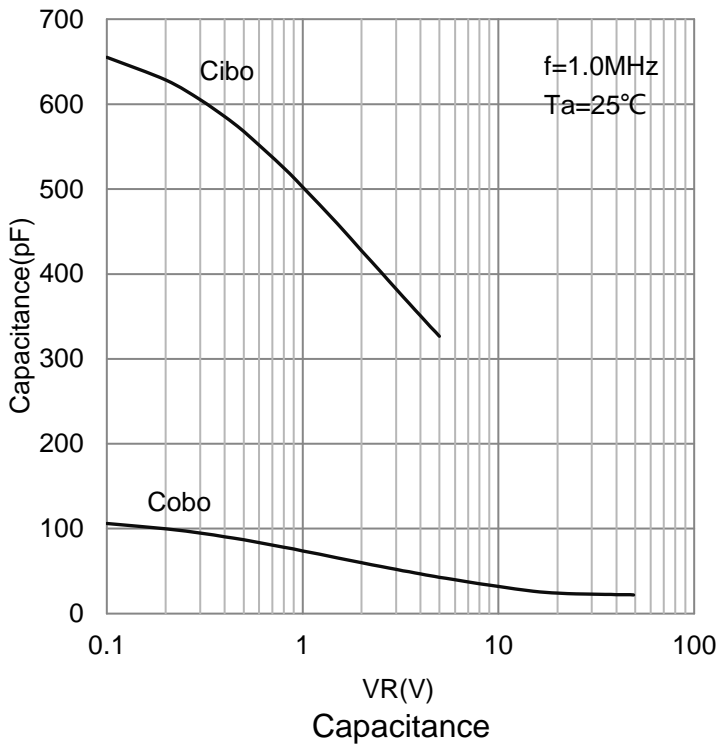
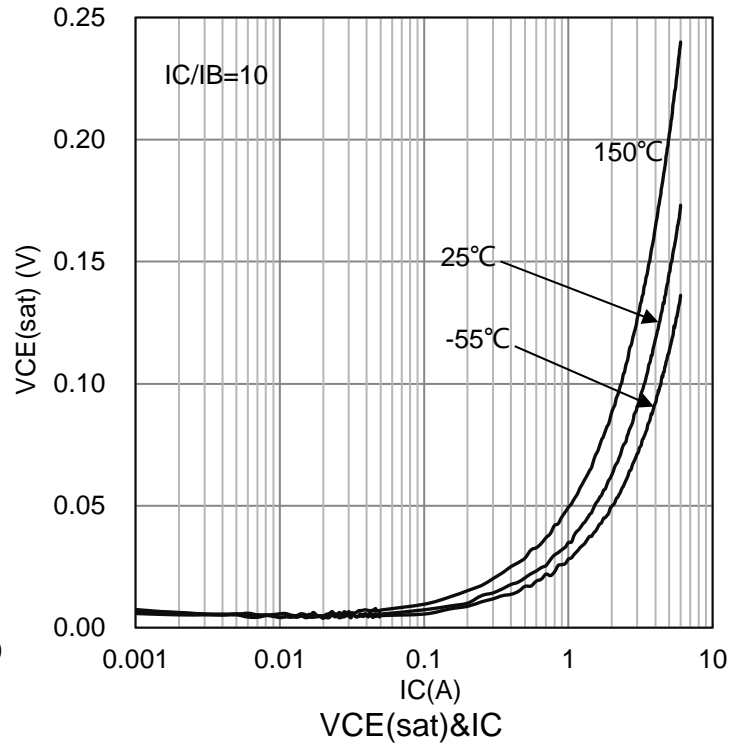
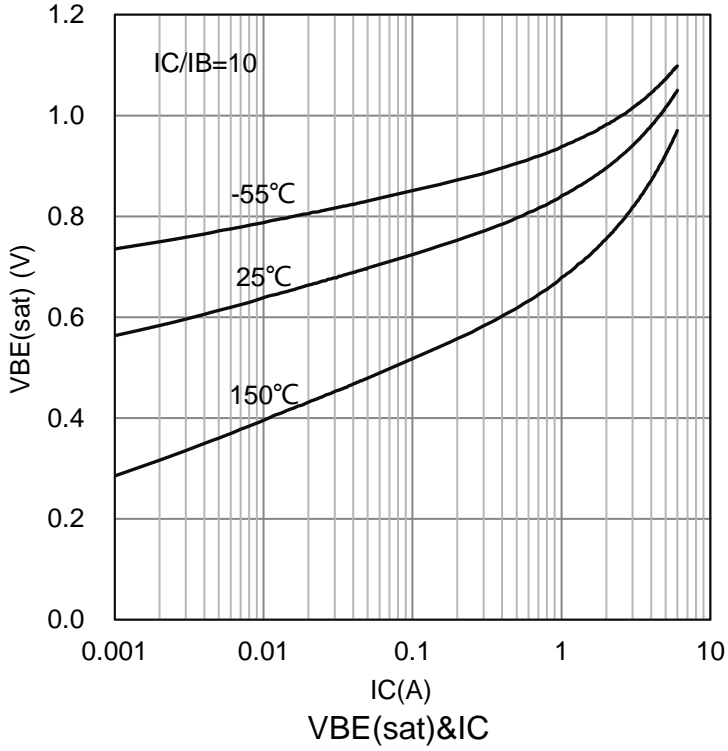
6.ELECTRICAL CHARACTERISTICS CURVES(Con.)

7. OUTLINE AND DIMENSIONS

SOT223

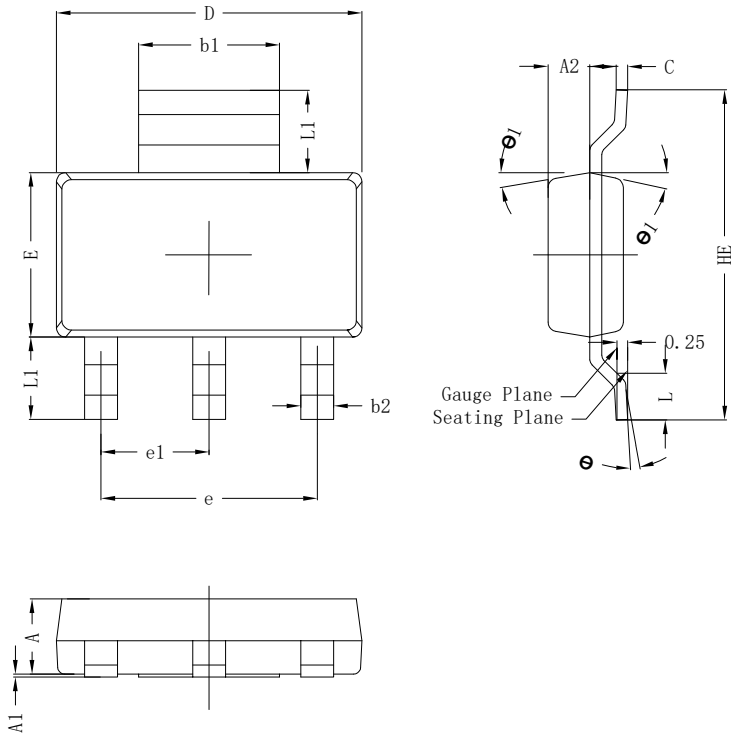

SOT223			
DIM	MIN	NOR	MAX
A	1.50	1.60	1.70
A1	0.00	0.05	0.10
A2	0.80	0.90	1.00
b1	2.90	3.02	3.10
b2	0.60	0.72	0.80
c	0.20	0.27	0.35
D	6.30	6.50	6.70
E	3.30	3.50	3.70
e	4.60BSC		
e1	2.30BSC		
HE	6.80	7.00	7.20
L	0.80	1.00	1.20
L1	1.75(REF)		
θ	0°~8°		
θ 1	8°	10°	12°
All Dimensions in mm			

GENERAL NOTES

1. Top package surface finish Ra0.4±0.2um
2. Bottom package surface finish Ra0.7±0.2um
3. Side package surface finish Ra0.4±0.2um
4. Protrusion or Gate Burrs shall not exceed 0.10mm per side.

8. SOLDERING FOOTPRINT

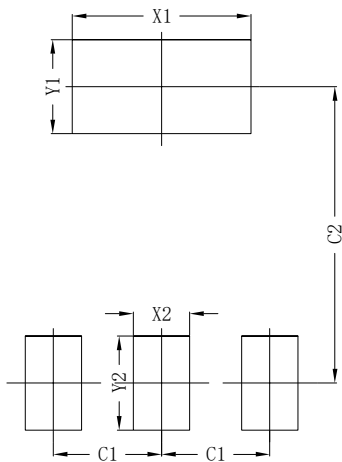

SOT223	
DIM	(mm)
X1	3.80
Y1	2.00
X2	1.20
Y2	2.00
C1	2.30
C2	6.30

DISCLAIMER

- Before you use our Products, you are requested to carefully read this document and fully understand its contents. LRC shall not be in any way responsible or liable for failure, malfunction or accident arising from the use of any LRC's Products against warning, caution or note contained in this document.
- All information contained in this document is current as of the issuing date and subject to change without any prior notice. Before purchasing or using LRC's Products, please confirm the latest information with a LRC sales representative.

单击下面可查看定价，库存，交付和生命周期等信息

[>>LRC\(乐山无线电\)](#)