

LTVS23H712CLT1G

ESD Protection Diodes

1. FEATURES

- Low capacitance.
- Low clamping voltage.
- ESD protection
- Complies with IEC 61000-4-2 standards: Air discharge: $\pm 30\text{kV}$
Contact discharge: $\pm 30\text{kV}$
- We declare that the material of product compliance with RoHS requirements and Halogen Free.

2. DEVICE MARKING AND ORDERING INFORMATION

Device	Marking	Shipping
LTVS23H712CLT1G	DM	3000/Tape&Reel

3. MAXIMUM RATINGS($T_a = 25^\circ\text{C}$)

Parameter	Symbol	Limits	Unit
IEC 61000-4-2 (ESD)	Contact	± 30	kV
	Air	± 30	
peak pulse power @ 8/20 μs	PPP	400	W
peak pulse current @ 8/20 μs	IPP	17	A
Storage Temperature Range	Tstg	$-55 \sim +150$	$^\circ\text{C}$
Operating Temperature Range	TJ	$-55 \sim +125$	$^\circ\text{C}$

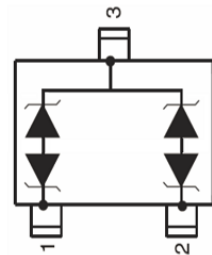
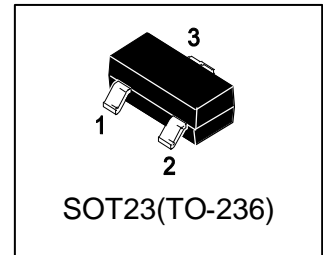

4. ELECTRICAL CHARACTERISTICS (Ta= 25°C)

Characteristic	Symbol	MIN	MIN	MAX	Unit
Reverse stand-off voltage (Pin 1、 2 to Pin 3) (Pin 3 to Pin 1、 2)	VRWM	-	-	12 7	V
Reverse breakdown voltage (IT = 1 mA, Pin 1、 2 to Pin 3) (IT = 1 mA, Pin 3 to Pin 1、 2)	VBR	13.3 7.5	- -	- -	V
Reverse leakage current (VR = VRWM, Pin 1、 2 to Pin 3) (VR = VRWM, Pin 3 to Pin 1、 2)	IR	- -	- -	100 200	nA
Clamping Voltage (IPP = 5A (8 x 20µs pulse), Pin 1、 2 to Pin 3) (IPP = 5A (8 x 20µs pulse), Pin 3 to Pin 1、 2) (IPP = 17A (8 x 20µs pulse), Pin 1、 2 to Pin 3) (IPP = 17A (8 x 20µs pulse), Pin 3 to Pin 1、 2)	VC	- - - -	- - - -	18 12 23 15	V
Junction Capacitance (VR = 0V, f = 1MHz, Pin 1、 2 to Pin 3) (VR = 0V, f = 1MHz, Pin 3 to Pin 1、 2) (VR = VRWM, f = 1MHz, Pin 1、 2 to Pin 3) (VR = VRWM, f = 1MHz, Pin 3 to Pin 1、 2)	CJ	- - - -	- - 32 35	75 75 - -	pF

5. ELECTRICAL CHARACTERISTICS CURVES

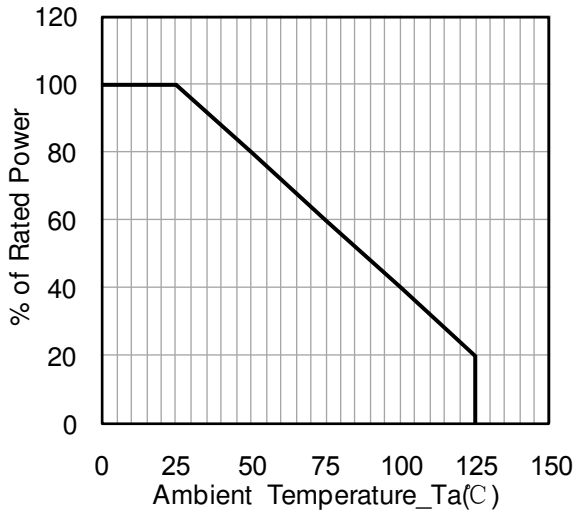

Figure 1. Power Derating Curve

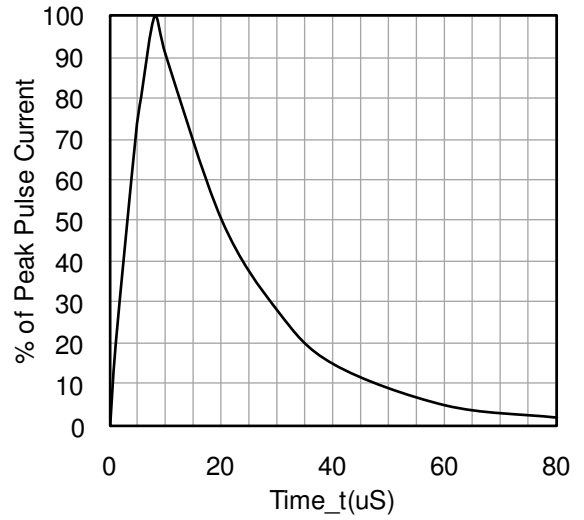

Figure 2. 8 X 20uS Pulse Waveform

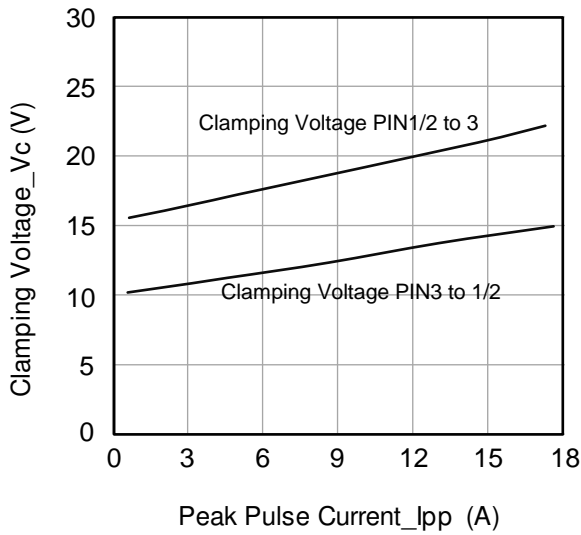

Figure 3. Clamping Voltage vs. Peak Pulse Current

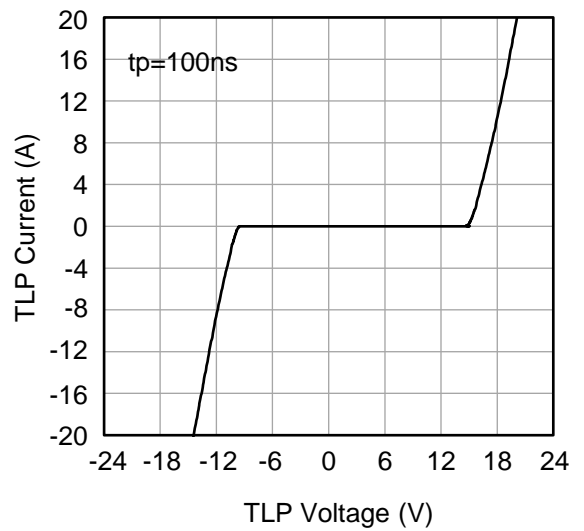
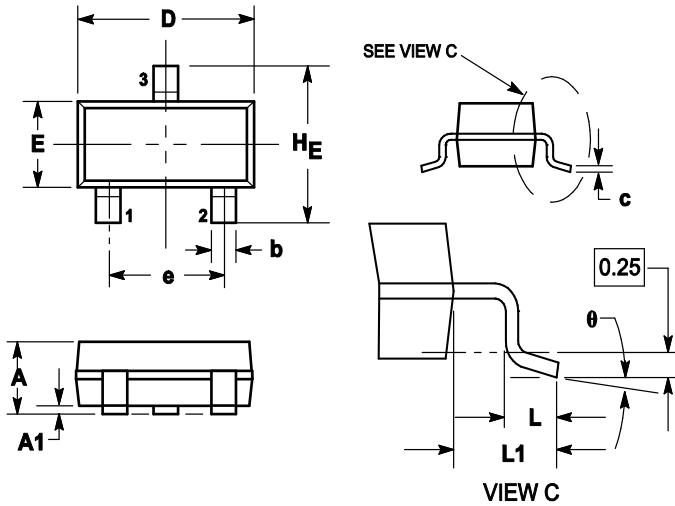

Figure 4. TLP Measurement

6. OUTLINE AND DIMENSIONS

Notes:

1. DIMENSIONING AND TOLERANCING PER ANSI Y14.5M, 1982.
2. CONTROLLING DIMENSION: MILLIMETERS.
3. MAXIMUM LEAD THICKNESS INCLUDES LEAD FINISH. MINIMUM LEAD THICKNESS IS THE MINIMUM THICKNESS OF BASE MATERIAL.
4. DIMENSIONS D AND E DO NOT INCLUDE MOLD FLASH, PROTRUSIONS OR GATE BURRS.



DIM	MILLIMETERS			INCHES		
	MIN	NOM	MAX	MIN	NOM	MAX
A	0.89	1	1.11	0.035	0.04	0.044
A1	0.01	0.06	0.1	0.001	0.002	0.004
b	0.37	0.44	0.5	0.015	0.018	0.02
c	0.09	0.13	0.18	0.003	0.005	0.007
D	2.80	2.9	3.04	0.11	0.114	0.12
E	1.20	1.3	1.4	0.047	0.051	0.055
e	1.78	1.9	2.04	0.07	0.075	0.081
L	0.10	0.2	0.3	0.004	0.008	0.012
L1	0.35	0.54	0.69	0.014	0.021	0.029
HE	2.10	2.4	2.64	0.083	0.094	0.104
θ	0°	---	10°	0°	---	10°

7. SOLDERING FOOTPRINT

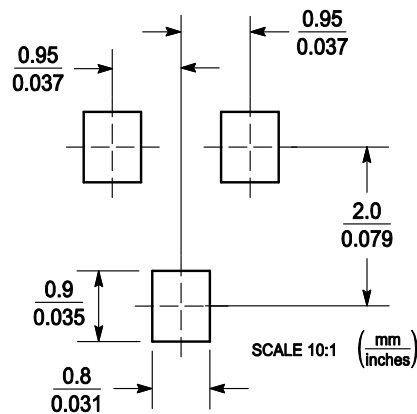

DISCLAIMER

- Before you use our Products, you are requested to carefully read this document and fully understand its contents. LRC shall not be in any way responsible or liable for failure, malfunction or accident arising from the use of any LRC's Products against warning, caution or note contained in this document.
- All information contained in this document is current as of the issuing date and subject to change without any prior notice. Before purchasing or using LRC's Products, please confirm the latest information with a LRC sales representative.

单击下面可查看定价，库存，交付和生命周期等信息

[>>LRC\(乐山无线电\)](#)