

# EFMC301 thru EFMC308

Surface Mount Glass Passivated Super Fast Rectifiers

Reverse Voltage 50V To 600V Forward Current 3.0A

## 1. FEATURES

- We declare that the material of product compliance with RoHS requirements and Halogen Free.
- Plastic package has Underwriters Laboratory Flammability Classification 94V-0.
- High temperature metallurgically bonded construction.
- Cavity-free glass passivated junction.
- Capable of meeting environmental standards of MIL-S-19500.
- For use in high frequency rectifier circuits.
- Fast Switching for high efficiency
- Typical IR less than 1.0 $\mu$ A.
- High temperature soldering guaranteed:260°C/10 seconds.
- Weight: 0.26g

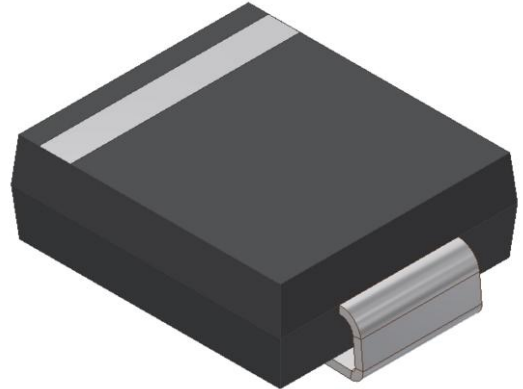

## 2. MAXIMUM RATINGS(Ta = 25°C)

Parameter	Symbol	EFMC 301	EFMC 302	EFMC 303	EFMC 304	EFMC 305	EFMC 306	EFMC 307	EFMC 308	Unit
Marking		EFMC 301	EFMC 302	EFMC 303	EFMC 304	EFMC 305	EFMC 306	EFMC 307	EFMC 308	
Maximum repetitive peak reverse voltage	VRRM	50	100	150	200	300	400	500	600	V
Maximum RMS voltage	VRMS	35	70	105	140	210	280	350	420	V
Maximum DC blocking voltage	VDC	50	100	150	200	300	400	500	600	V
Maximum average forward rectified current at TC = 75°C	IF(AV)	3								A
Peak forward surge current 8.3ms single half sine-wave superimposed on rated load (JEDEC Method)	IFSM	80								A
Typical thermal resistance (Note 1)	R $\theta$ JA	160								°C/W
	R $\theta$ JC	50								
Operating junction and storage temperature range	TJ, TSTG	-50 ~+150								°C

## 3. ELECTRICAL CHARACTERISTICS (Ta= 25°C)

Characteristic	Symbol	EFMC 301	EFMC 302	EFMC 303	EFMC 304	EFMC 305	EFMC 306	EFMC 307	EFMC 308	Unit
Maximum instantaneous forward voltage at 3.0A	VF	0.95			1.25		1.70			V
Maximum DC reverse current TA = 25°C at rated DC blocking voltage TJ = 125°C	IR	5								$\mu$ A
		100								
Typical reverse recovery time (Note 2)	trr	35								ns
Typical junction capacitance at 4.0V, 1MHz	CJ	15								PF

1. 8.0mm<sup>2</sup> (.013mm thick) land areas

**4. ELECTRICAL CHARACTERISTICS CURVES**

Fig. 1 - Forward Current Derating Curve

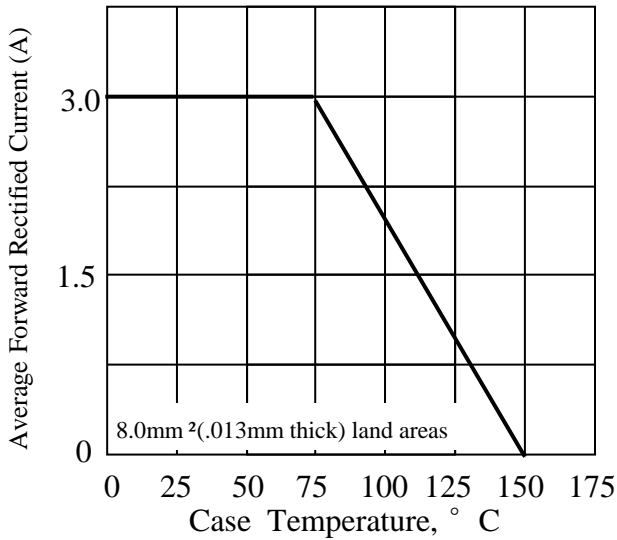

Fig. 2 - Maximum Non-repetitive Peak Forward Surge Current

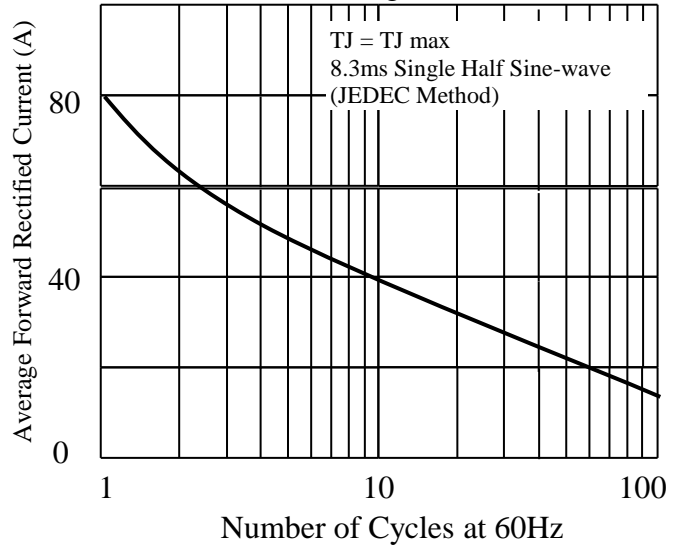

Fig. 3 - Typical Instantaneous Forward Characteristics

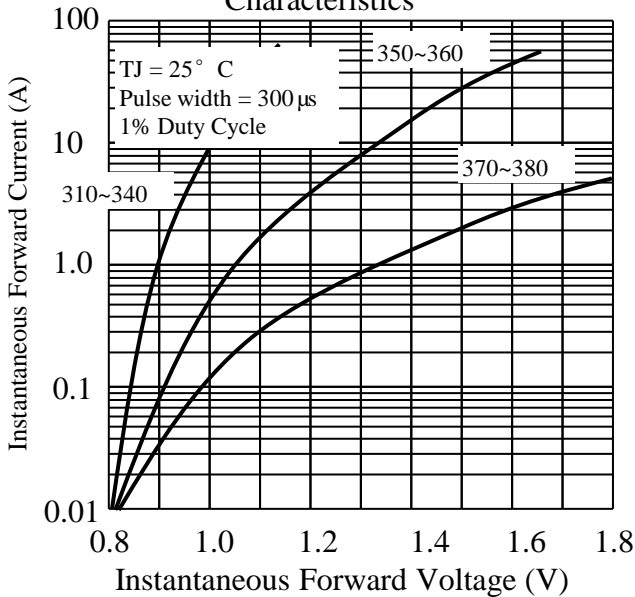

Fig. 4 - Typical Reverse Characteristics

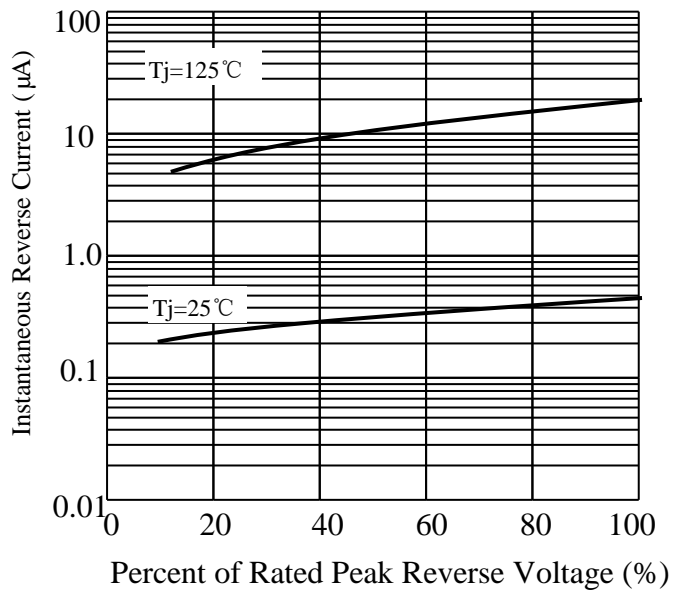
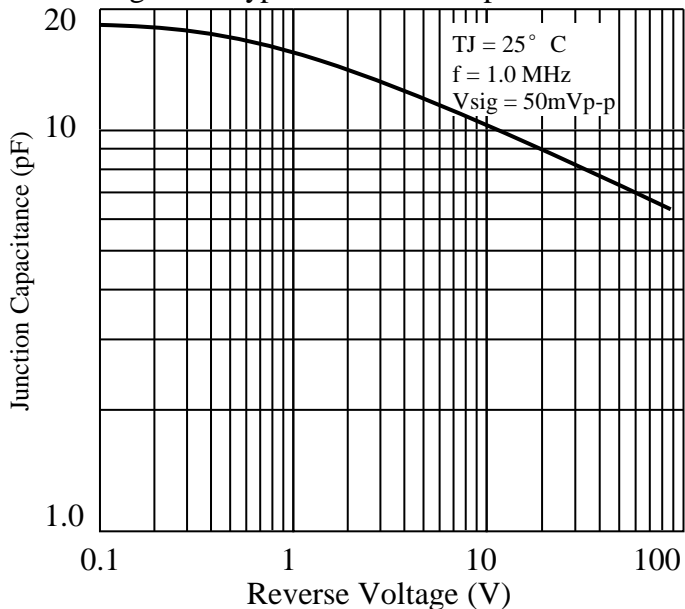
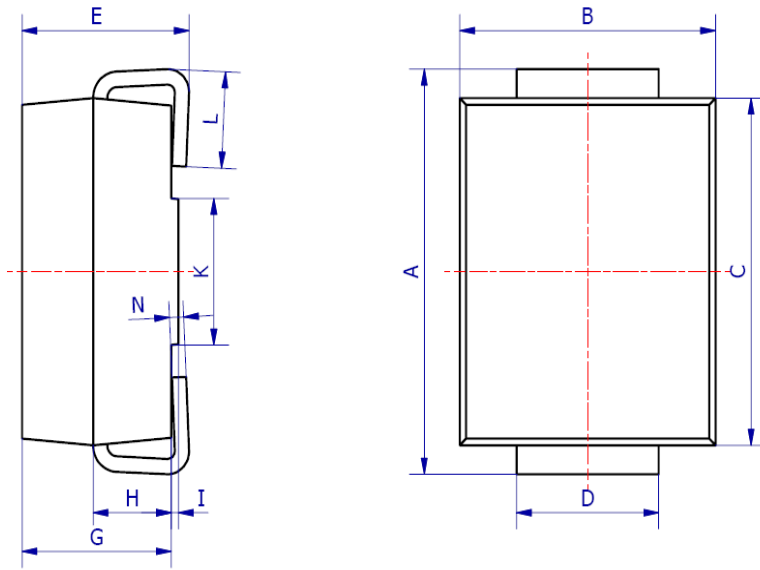

Fig. 5 - Typical Junction Capacitance



### 5. OUTLINE AND DIMENSIONS



SMC			
DIM	Min	Max	Typ.
A	7.70	8.30	8.00
B	5.85	6.25	6.05
C	6.65	7.05	6.85
D	2.80	3.20	3.00
E	2.45	2.85	2.65
G	2.10	2.50	2.30
H	1.00	1.40	1.20
I	0.05	0.15	0.10
K	4.30	4.70	4.50
L	1.00	1.50	1.25
N	0.10	0.30	0.20
All Dimensions in mm			

### 6. SOLDERING FOOTPRINT

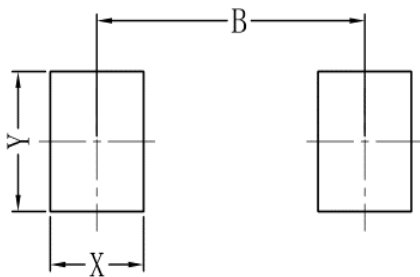

SMC	
DIM	(mm)
X	1.60
Y	3.30
B	6.60

单击下面可查看定价，库存，交付和生命周期等信息

[>>LRC\(乐山无线电\)](#)