

Small Signal MOSFET

115 mAmps, 60 Volts

N-Channel SOT-723

- Pb-Free Package is Available.
- ESD Protected:2000V
- S- Prefix for Automotive and Other Applications Requiring Unique Site and Control Change Requirements; AEC-Q101 Qualified and PPAP Capable.

ORDERING INFORMATION

Device	Marking	Shipping
L2N7002EM3T5G S-L2N7002EM3T5G	RK	8000 Tape & Reel

MAXIMUM RATINGS

Rating	Symbol	Value	Unit
Drain-Source Voltage	V_{DSS}	60	V _{dc}
Drain Current - Continuous $T_C = 25^\circ\text{C}$ (Note 1.) - Pulse $t < 10\mu\text{s}$	I_D I_{DM}	± 115 ± 800	mAdc
Gate-Source Voltage - Continuous	V_{GS}	± 20	V _{dc}

THERMAL CHARACTERISTICS

Characteristic	Symbol	Max	Unit
Total Device Dissipation FR-5 Board (Note 2.) $T_A = 25^\circ\text{C}$ Derate above 25°C	P_D	150 1.2	mW mW/ $^\circ\text{C}$
Thermal Resistance, Junction to Ambient	$R_{\theta JA}$	833	$^\circ\text{C}/\text{W}$
Junction and Storage Temperature	T_J, T_{stg}	-55 to +150	$^\circ\text{C}$

1. The Power Dissipation of the package may result in a lower continuous drain current.
2. FR-5 = 1.0 x 0.75 x 0.062 in.
3. Alumina = 0.4 x 0.3 x 0.025 in 99.5% alumina.

L2N7002EM3T5G
S-L2N7002EM3T5G

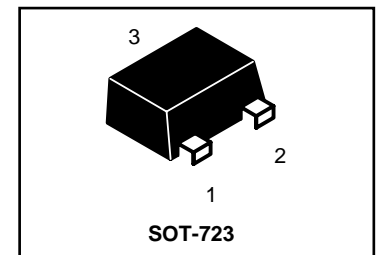

N - Channel

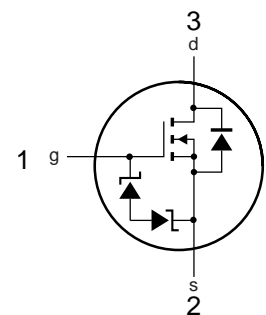

MARKING DIAGRAM & PIN ASSIGNMENT

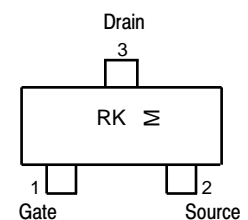

RK = Device Code
M = Month Code

L2N7002EM3T5G , S-L2N7002EM3T5G

● Electrical characteristics (Ta=25°C)

Parameter	Symbol	Min.	Typ.	Max.	Unit	Test Conditions
Gate-source leakage current	I _{GSS}	-	-	±10	μA	V _{GS} =±20V, V _{DS} =0V
Drain-source breakdown voltage	V _{(BR)DSS}	60	-	-	V	I _D =10μA, V _{GS} =0V
Zero gate voltage drain current	I _{DSS}	-	-	1	μA	V _{DS} =60V, V _{GS} =0V
Gate threshold voltage	V _{GS(th)}	1	1.85	2.5	V	V _{DS} =V _{GS} , I _D =250μA
Drain-source on-state resistance	R _{DS(on)*}	-	-	7.5	Ω	I _D =0.5A, V _{GS} =10V
		-	-	7.5		I _D =0.05A, V _{GS} =5V
Forward transfer admittance	Y _{fs} *	80	-	-	mS	V _{DS} =10V, I _D =0.2A
Input capacitance	C _{iss}	-	25	50	pF	V _{DS} =25V
Output capacitance	C _{oss}	-	10	25	pF	V _{GS} =0V
Reverse transfer capacitance	C _{rss}	-	3.0	5.0	pF	f=1MHz
Turn-on delay time	t _{d(on)*}	-	12	20	ns	I _D =200mA, V _{DD} =30V
Turn-off delay time	t _{d(off)*}	-	20	30	ns	V _{GS} =10V, R _L =150Ω, R _{GS} =10Ω

* Pw≤300μs, Duty cycles≤1%

● Electrical characteristic curves

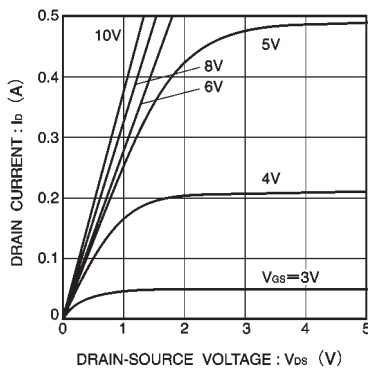

Fig.1 Typical output characteristics

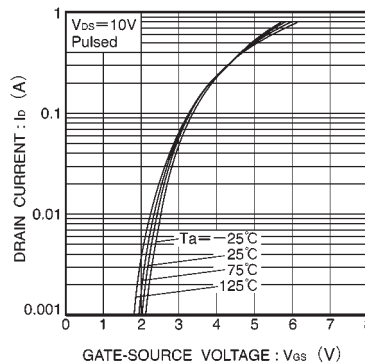

Fig.2 Typical transfer characteristics

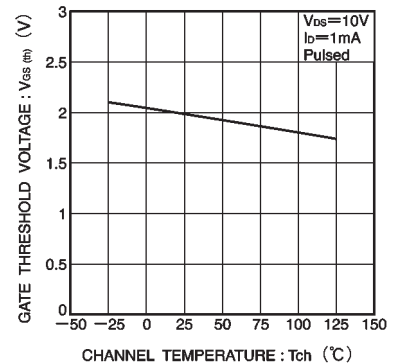

Fig.3 Gate threshold voltage vs. channel temperature

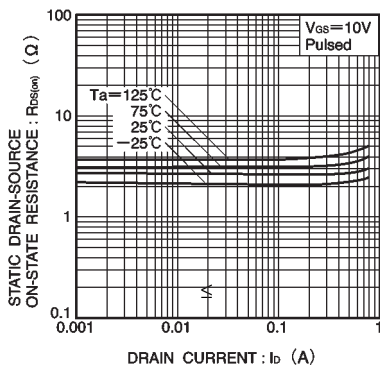

Fig.4 Static drain-source on-state resistance vs. drain current (I)

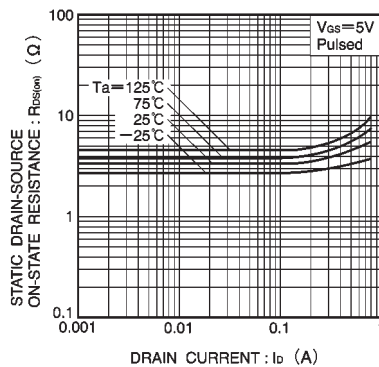

Fig.5 Static drain-source on-state resistance vs. drain current (II)

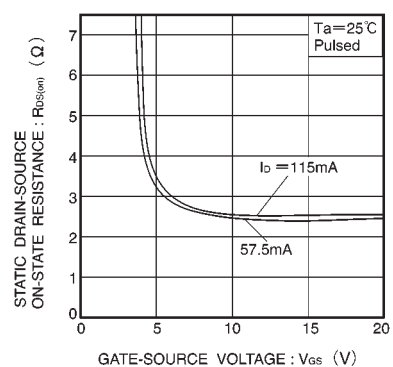

Fig.6 Static drain-source on-state resistance vs. gate-source voltage

L2N7002EM3T5G , S-L2N7002EM3T5G

●Electrical characteristic curves (continues)

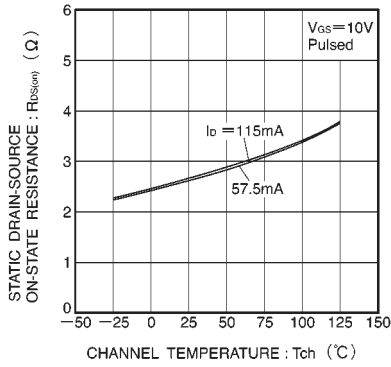

Fig.7 Static drain-source on-state resistance vs. channel temperature

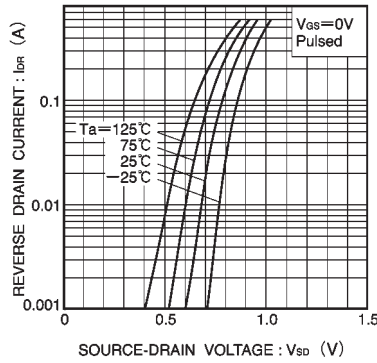

Fig.8 Reverse drain current vs. source-drain voltage (I)

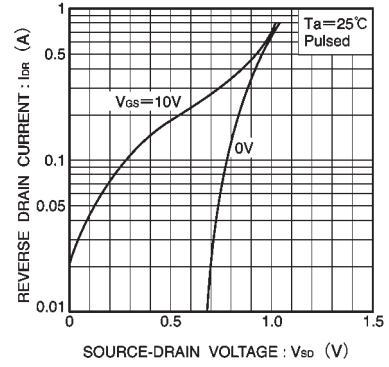

Fig.9 Reverse drain current vs. source-drain voltage (II)

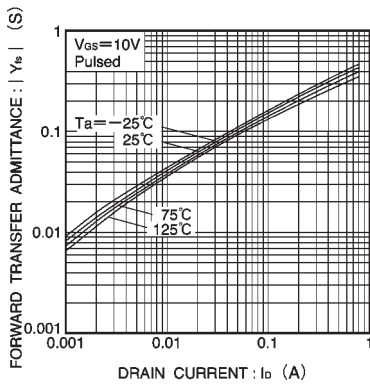

Fig.10 Forward transfer admittance vs. drain current

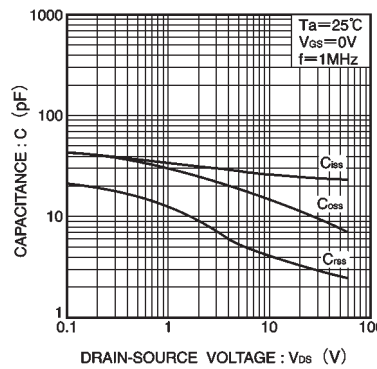

Fig.11 Typical capacitance vs. drain-source voltage

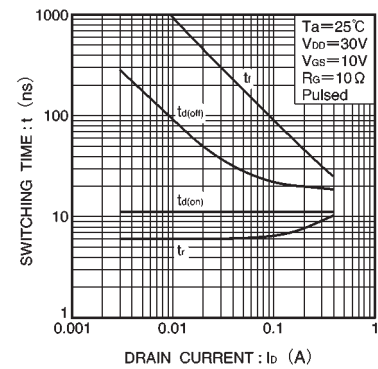

Fig.12 Switching characteristics
(See Figures 13 and 14 for the measurement circuit and resultant waveforms)

●Switching characteristics measurement circuit

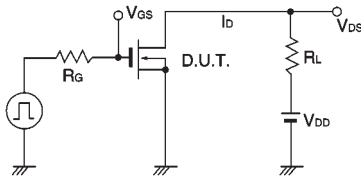

Fig.13 Switching time measurement circuit

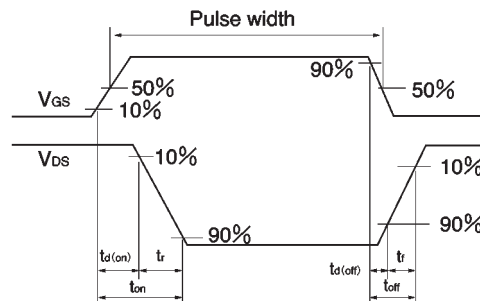
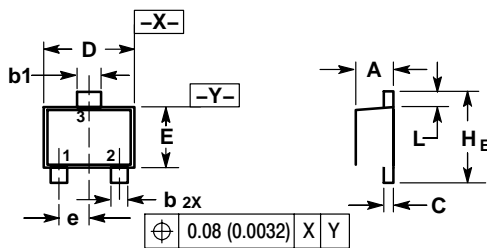

Fig.14 Switching time waveforms

SOT-723



NOTES:

1. DIMENSIONING AND TOLERANCING PER ANSI Y14.5M, 1982.
2. CONTROLLING DIMENSION: MILLIMETERS.
3. MAXIMUM LEAD THICKNESS INCLUDES LEAD FINISH. MINIMUM LEAD THICKNESS IS THE MINIMUM THICKNESS OF BASE MATERIAL.
4. DIMENSIONS D AND E DO NOT INCLUDE MOLD FLASH, PROTRUSIONS OR GATE BURRS.

DIM	MILLIMETERS			INCHES		
	MIN	NOM	MAX	MIN	NOM	MAX
A	0.45	0.50	0.55	0.018	0.020	0.022
b	0.15	0.20	0.27	0.0059	0.0079	0.0106
b1	0.25	0.3	0.35	0.010	0.012	0.014
C	0.07	0.12	0.17	0.0028	0.0047	0.0067
D	1.15	1.20	1.25	0.045	0.047	0.049
E	0.75	0.80	0.85	0.03	0.032	0.034
e	0.40 BSC			0.016 BSC		
H E	1.15	1.20	1.25	0.045	0.047	0.049
L	0.15	0.20	0.25	0.0059	0.0079	0.0098

SOLDERING FOOTPRINT

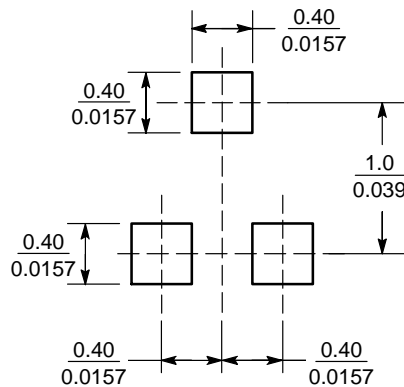

(mm)
(inches)

单击下面可查看定价，库存，交付和生命周期等信息

[>>LRC\(乐山无线电\)](#)