

SB820-HE thru SB8100-HE

Schottky Barrier Rectifiers

Reverse Voltage 20 to 100V Forward Current 8.0A

Feature & Dimensions

- * Plastic package has underwriters laboratory Flammability classification 94V-0
- * Low power loss, high efficiency
- * For use in low voltage high frequency inverters, free wheeling, and polarity protection applications
- * Guarding for over voltage protection
- * High temperature soldering guaranteed: 260°C/10 seconds at terminals

Mechanical Data

Case : JEDEC DO-201AD, molded plastic over sky die
 Terminals : Plated axial leads, solderable per MIL-STD-750, Method 2026
 Polarity : Color band denotes cathode end
 Weight : 0.038oz., 1.03 g
 Mounting position : Any
 Handling precaution : None

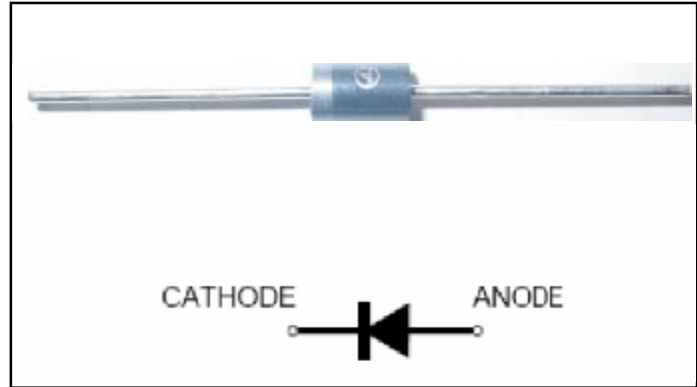

we declare that the material of product is halogen free (green epoxy compound).

1. Maximum & Thermal Characteristics Ratings at 25°C ambient temperature unless otherwise specified.

Parameter symbol	Symbol	SB820-HE	SB830-HE	SB840-HE	SB850-HE	SB860-HE	SB880-HE	SB8100-HE	Unit
Device marking code		SB820 ESD	SB830 ESD	SB840 ESD	SB850 ESD	SB860 ESD	SB880E SD	SB8100 ESD	
Maximum repetitive peak reverse voltage	V _{RRM}	20	30	40	50	60	80	100	V
Maximum RMS voltage	V _{RMS}	14	21	28	35	42	56	70	V
Maximum DC blocking voltage	V _{DC}	20	30	40	50	60	80	100	V
Maximum average forward rectified current 0.375" (9.5mm) lead length (See fig. 1)	IF(AV)	8.0							A
maximum average forward rectified current at case temperature 120C is missing.	IF(AV)	3.5							A
Peak forward surge current 8.3ms single half sine-wave superimposed on rated load (JEDEC Method)	I _{FSM1}	150							A
Peak forward surge current 1.0ms single half sine-wave superimposed on rated load	I _{FSM2}	200							A
ESD According to Flexpower specification ESD test manual 1.3		15							KV
Thermal resistance, junction to ambient	R _{θJA}	35							°C/W
Thermal resistance, junction to case	R _{θJC}	5							°C/W
Operating junction and storage temperature range	T _J , T _{STG}	-65 to +150							°C

Electrical Characteristics Ratings at 25°C ambient temperature unless otherwise specified.

Parameter symbol	Symbol	SB820-HE	SB830-HE	SB840-HE	SB850-HE	SB860-HE	SB880-HE	SB8100-HE	Unit
Maximum instantaneous forward voltage at 8.0A	VF	0.60			0.70		0.84		V
Maximum DC reverse current TC = 25°C	I _r	1							mA
ton=8ms; toff=35ms TC = 120°C	I _r	10							mA
ton=8ms; toff=35ms TC = 140°C	I _r	30							mA
Maximum reverse recovery time TC = 25°C	T _{rr}	30							ns
TC = 120°C	T _{rr}	50							ns
Typical junction capacitance at 4.0V, 1MHz	C _J	500			380				PF

SB820-HE thru SB8100-HE

Parameters	Application conditions	Min	Typical	Max
Repetitive inrush current capability (cycles) only for rectifiers	Valid for whole temperature range and with 20μF foil capacitor and R3 placed in series to the DUT. Change the value of R3 to get the peak value of the first pulse to 33A. Adjust 10s between each pulse. Vout=400VDC. Inrush current= 33A. See Note 2	10000		
	Take new samples. Valid for whole temperature range and with 20μF foil capacitor and R3 placed in series to the DUT. Change the value of R3 to get the peak value of the first pulse to 42A. Adjust 10s between each pulse. Vout=500VDC. Inrush current= 42A. See Note2	5000		
	take new samples. valid for whole temperature range and with 20μF foil capacitor and R3 placed in series to the DUT. Change the value of R3 to get the peak value of the first pulse to 50A. Adjust 10s between each pulse. Vout=594VDC. Inrush current= 50A. See Note 2	1000		

Notes:

Note 1. Thermal resistance from junction to ambient at 0.375" (9.5mm) lead length, P.C.B. mounted

Note 2 : Schematic diagram of the test setup inrush current.

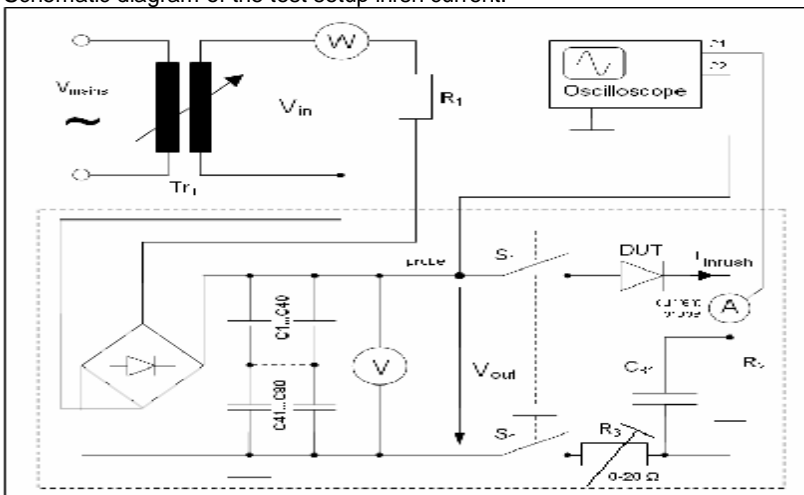

- C1...C40 = 560μF /400V; approximately. 22mF in sum (C1...C40 in parallel). ESR C1...C40 ≤ 0,5R
- C41...C80 = 560μF /400V; approximately. 22mF in sum (C41...C80 in parallel). ESR C41...C80 ≤ 0,5R
- C81 = 20μF /600v foil capacitor. ESR C81 ≤ 0,1R
- R1 = 80R0 /50W (4 x 20R /50W in series) protection resistor for the rectifiers
- R2 = 50k / 10W / 600V discharge resistor for C81
- R3 = 0 - 20Ω / 30W current limiter (low inductive, repetitive peak maximum working voltage 600V)
- S1, S2 = Switch (Relays); Siemens 3TF46 (3 phases switch connected in parallel) I_{max(rms)}= 80A; 600Vac; I_s ≤ 50kA; 690Vac; s=short-circuited;

SB820-HE thru SB8100-HE

2. Characteristic Curves (TA = 25°C unless otherwise noted)

Fig. 1 - Forward Current Derating Curve

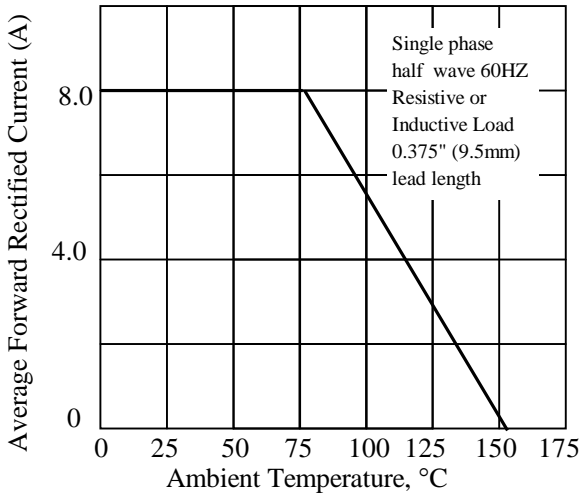

Fig. 2 - Maximum Non-repetitive Peak Forward Surge Current

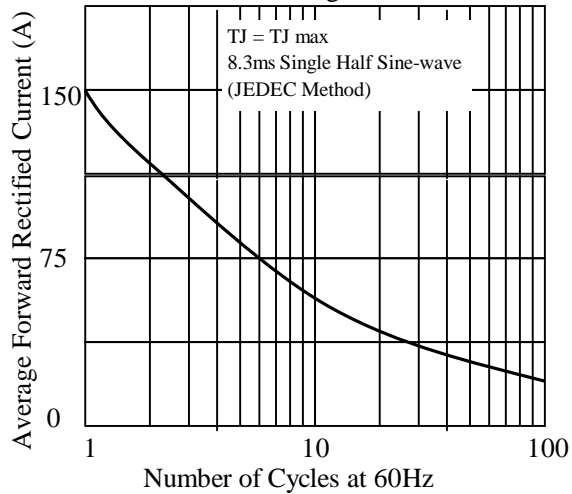

Fig 3. - Typical Instantaneous Forward Characteristics

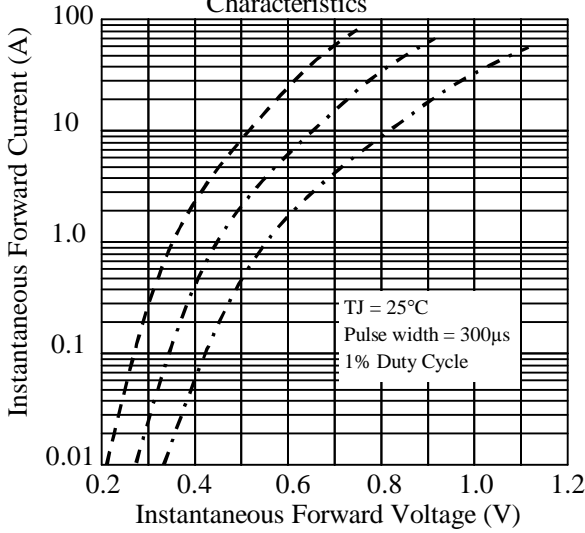

Fig 4. - Typical Reverse Characteristics

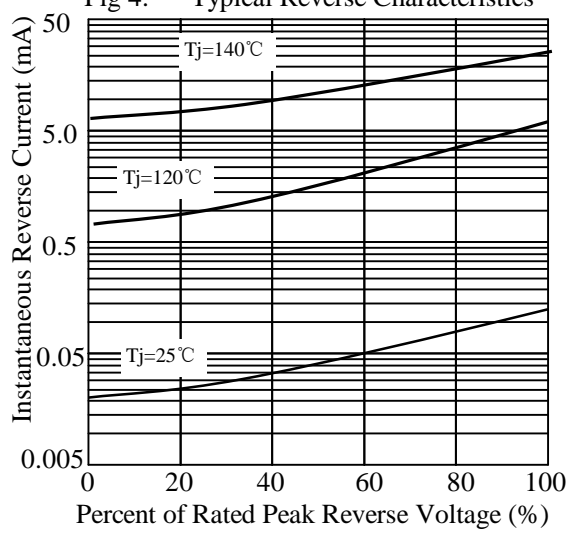

Fig 5. - typical transient thermal impedance

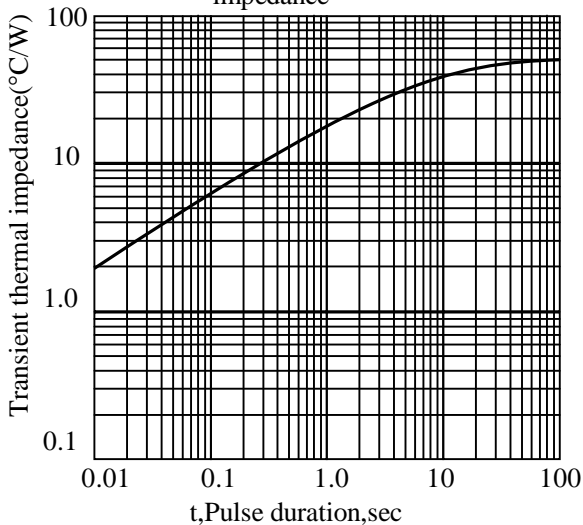
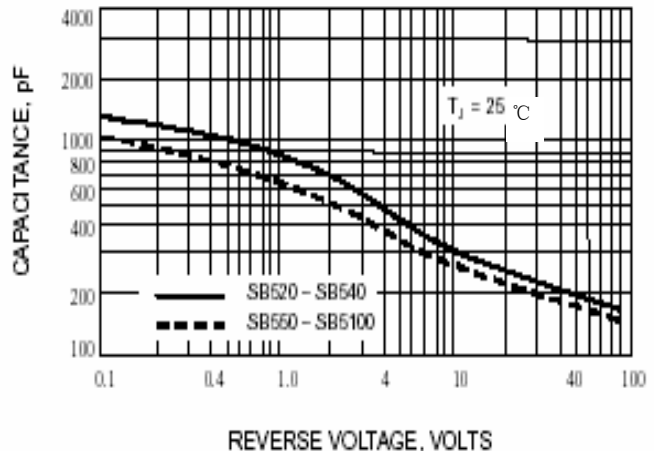
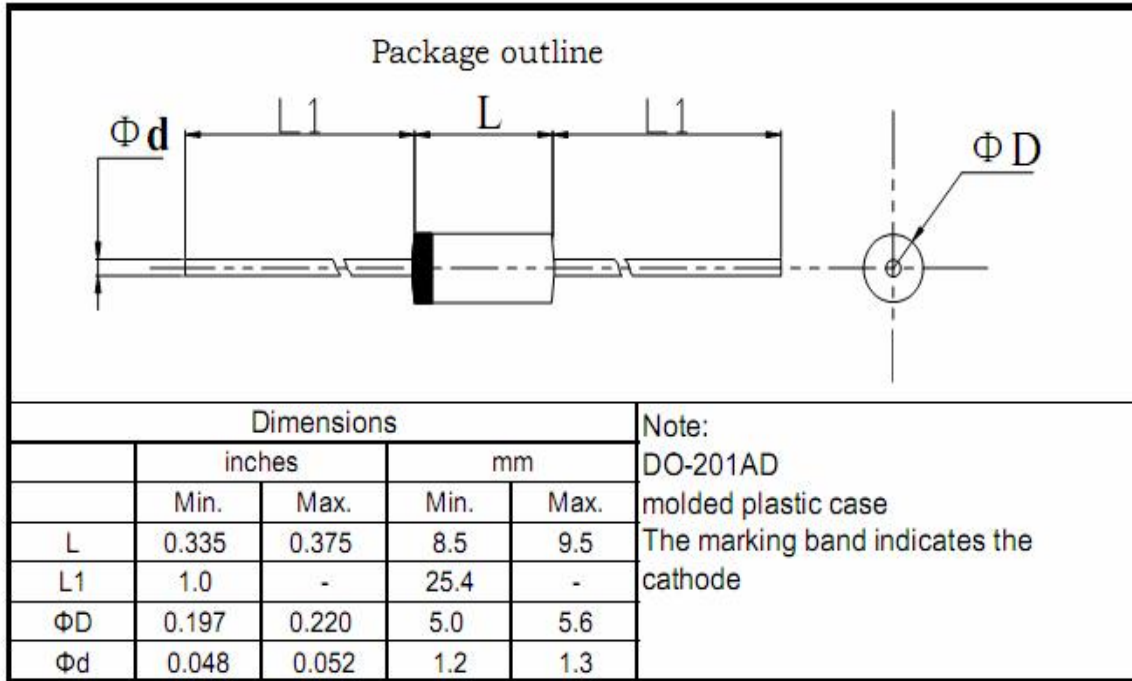

Fig 6. - Typical Junction Capacitance



SB820-HE thru SB8100-HE

3. dimension:



SB820-HE thru SB8100-HE

4. Update Record

版次	更新记录	更新作者	更新日期
1	第一版	周杰	2010-5-5

单击下面可查看定价，库存，交付和生命周期等信息

[>>LRC\(乐山无线电\)](#)