

General Description

The MDF13N50 uses advanced Magnachip's MOSFET Technology, which provides low on-state resistance, high switching performance and excellent quality.

MDF13N50 is suitable device for SMPS, high Speed switching and general purpose applications.

Features

- $V_{DS} = 500V$
- $V_{DS} = 550V @ T_{jmax}$
- $I_D = 13.0A @ V_{GS} = 10V$
- $R_{DS(ON)} \leq 0.5\Omega @ V_{GS} = 10V$

Applications

- Power Supply
- HID
- Lighting

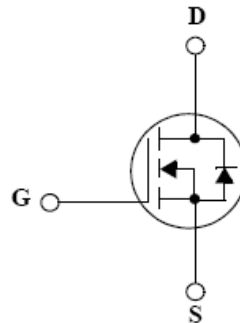

Absolute Maximum Ratings (Ta = 25°C)

Characteristics	Symbol	Rating	Unit	
Drain-Source Voltage	V_{DSS}	500	V	
Drain-Source Voltage @ T_{jmax}	$V_{DSS} @ T_{jmax}$	550	V	
Gate-Source Voltage	V_{GSS}	±30	V	
Continuous Drain Current (※)	I_D	$T_C=25^\circ C$	13	A
		$T_C=100^\circ C$	8.2	A
Pulsed Drain Current ⁽¹⁾	I_{DM}	52	A	
Power Dissipation	P_D	$T_C=25^\circ C$	41	W
		Derate above 25 °C	0.33	W/°C
Peak Diode Recovery dv/dt ⁽³⁾	Dv/dt	4.5	V/ns	
Single Pulse Avalanche Energy ⁽⁴⁾	E_{AS}	580	mJ	
Junction and Storage Temperature Range	T_J, T_{stg}	-55~150	°C	

※ I_D limited by maximum junction temperature

Thermal Characteristics

Characteristics	Symbol	Rating	Unit
Thermal Resistance, Junction-to-Ambient ⁽¹⁾	$R_{\theta JA}$	62.5	°C/W
Thermal Resistance, Junction-to-Case ⁽¹⁾	$R_{\theta JC}$	3.05	

Ordering Information

Part Number	Marking	Temp. Range	Package	Packing	RoHS Status
MDF13N50TH	MDF13N50	-55~150°C	TO-220F	Tube	Halogen Free

Electrical Characteristics (Ta =25°C)

Characteristics	Symbol	Test Condition	Min	Typ	Max	Unit
Static Characteristics						
Drain-Source Breakdown Voltage	BV_{DSS}	$I_D = 250\mu A, V_{GS} = 0V$	500	-	-	V
Gate Threshold Voltage	$V_{GS(th)}$	$V_{DS} = V_{GS}, I_D = 250\mu A$	3.0	-	5.0	
Drain Cut-Off Current	I_{DSS}	$V_{DS} = 500V, V_{GS} = 0V$	-	-	1	μA
Gate Leakage Current	I_{GSS}	$V_{GS} = \pm 30V, V_{DS} = 0V$	-	-	100	nA
Drain-Source ON Resistance	$R_{DS(ON)}$	$V_{GS} = 10V, I_D = 6.5A$	-	0.39	0.5	Ω
Forward Transconductance	g_{fs}	$V_{DS} = 40V, I_D = 6.5A$	-	13	-	S
Dynamic Characteristics						
Total Gate Charge	Q_g	$V_{DS} = 400V, I_D = 13A, V_{GS} = 10V^{(3)}$	-	33	-	nC
Gate-Source Charge	Q_{gs}		-	10.4	-	
Gate-Drain Charge	Q_{gd}		-	13	-	
Input Capacitance	C_{iss}	$V_{DS} = 25V, V_{GS} = 0V, f = 1.0MHz$	-	1390	-	pF
Reverse Transfer Capacitance	C_{rss}		-	6.3	-	
Output Capacitance	C_{oss}		-	173	-	
Turn-On Delay Time	$t_{d(on)}$	$V_{GS} = 10V, V_{DS} = 250V, I_D = 13A, R_G = 25\Omega^{(3)}$	-	30.2	-	ns
Rise Time	t_r		-	52.8	-	
Turn-Off Delay Time	$t_{d(off)}$		-	60.8	-	
Fall Time	t_f		-	33.8	-	
Drain-Source Body Diode Characteristics						
Maximum Continuous Drain to Source Diode Forward Current	I_S	-	-	13	-	A
Source-Drain Diode Forward Voltage	V_{SD}	$I_S = 13A, V_{GS} = 0V$	-	-	1.4	V
Body Diode Reverse Recovery Time	t_{rr}	$I_F = 13A, di/dt = 100A/\mu s^{(3)}$	-	325	-	ns
Body Diode Reverse Recovery Charge	Q_{rr}		-	2.9	-	μC

Note :

- Pulse width is based on $R_{\theta JC}$ & $R_{\theta JA}$ and the maximum allowed junction temperature of 150°C.
- Pulse test: pulse width $\leq 300\mu s$, duty cycle $\leq 2\%$, pulse width limited by junction temperature $T_{J(MAX)}=150^\circ C$.
- $I_{SD} \leq 9.0A$, $di/dt \leq 200A/\mu s$, $V_{DD}=50V$, $R_G = 25\Omega$, Starting $T_J=25^\circ C$
- $L=6.2mH$, $I_{AS}=13.0A$, $V_{DD}=50V$, $R_G = 25\Omega$, Starting $T_J=25^\circ C$

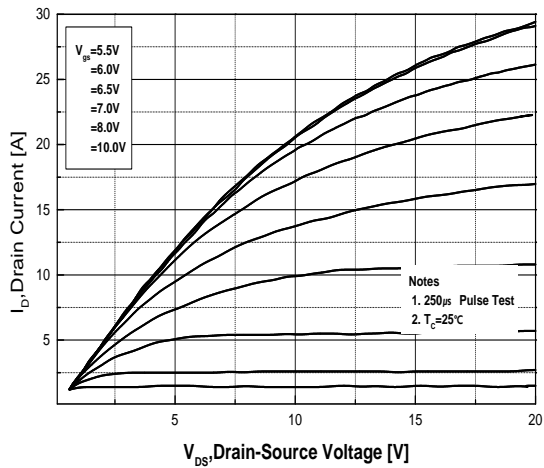

Fig.1 On-Region Characteristics

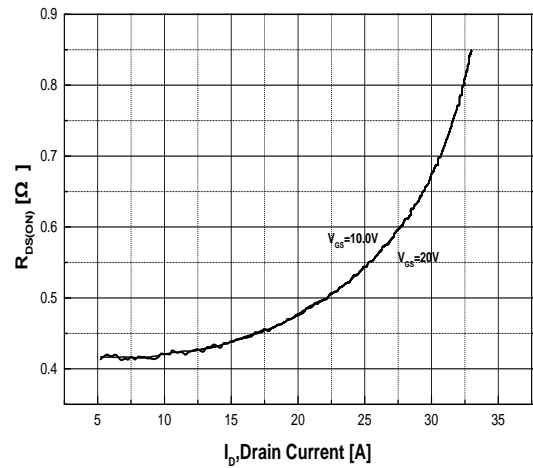

Fig.2 On-Resistance Variation with Drain Current and Gate Voltage

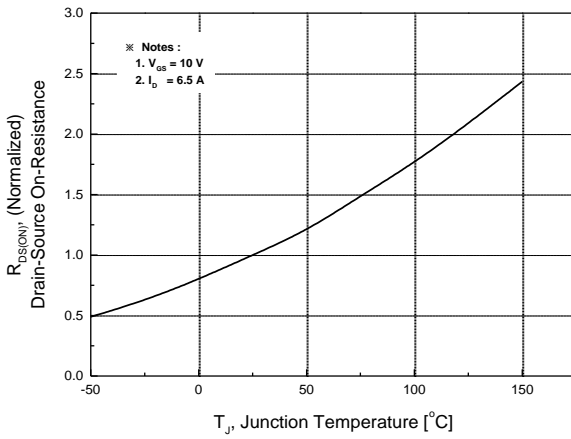

Fig.3 On-Resistance Variation with Temperature

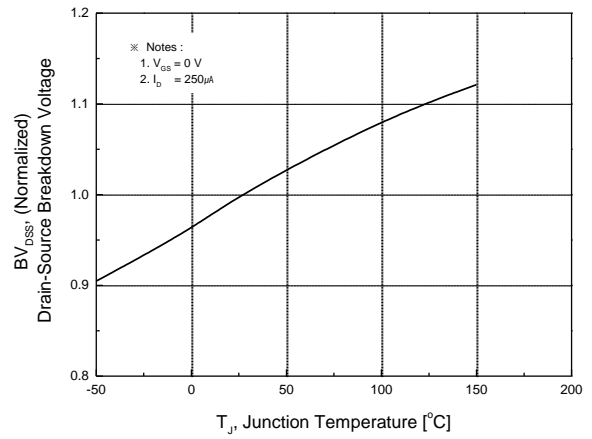

Fig.4 Breakdown Voltage Variation vs. Temperature

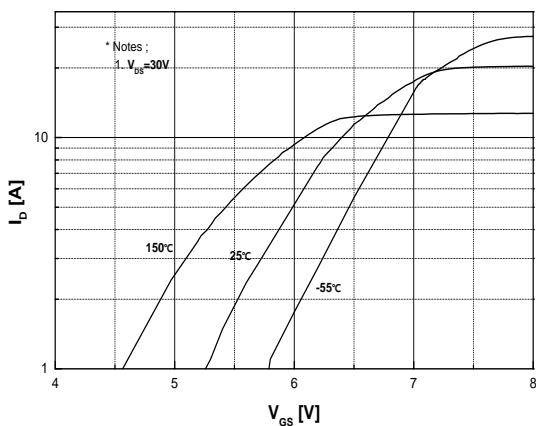

Fig.5 Transfer Characteristics

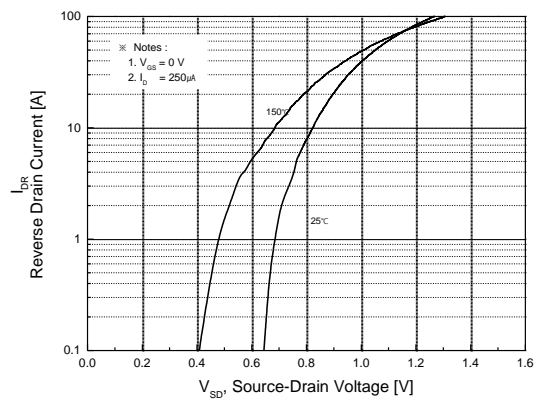

Fig.6 Body Diode Forward Voltage Variation with Source Current and Temperature

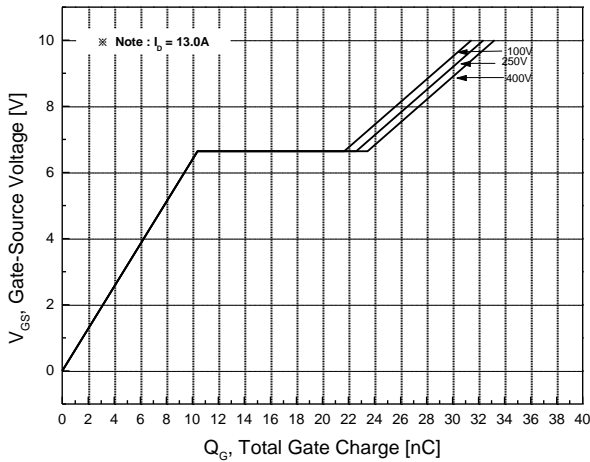

Fig.7 Gate Charge Characteristics

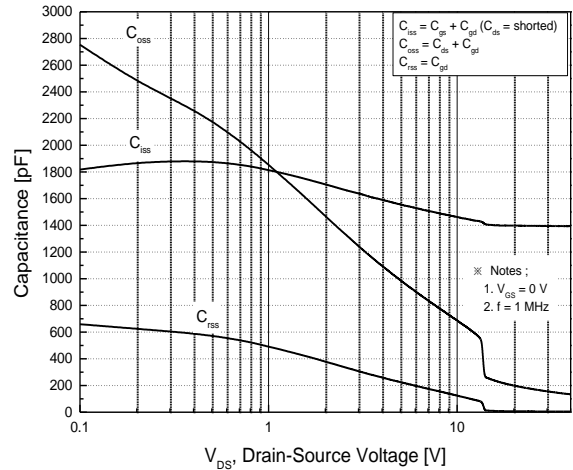

Fig.8 Capacitance Characteristics

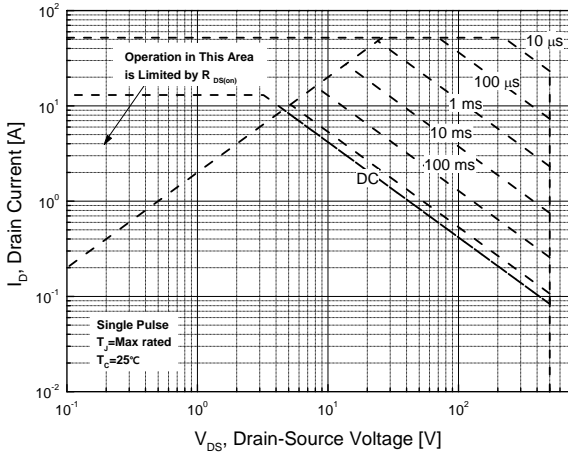

Fig.9 Maximum Safe Operating Area

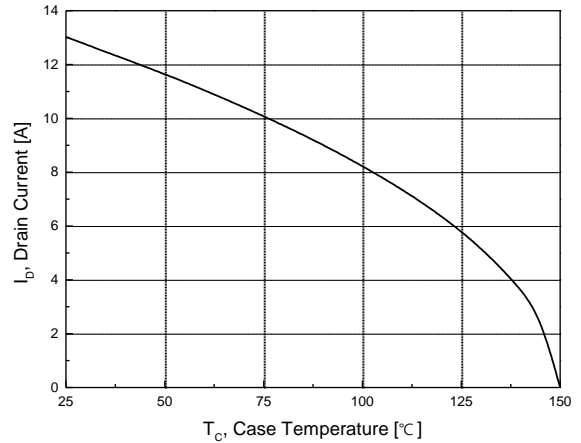

Fig.10 Maximum Drain Current vs. Case Temperature

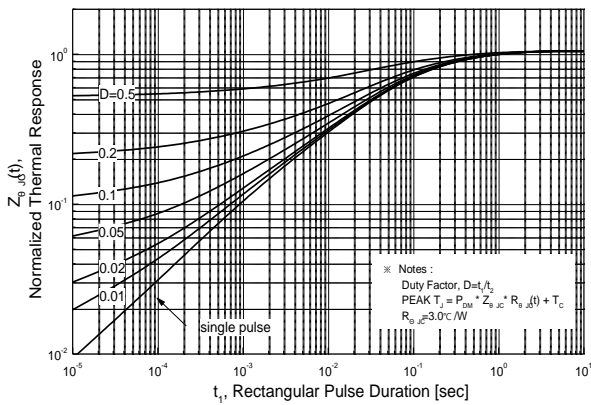

Fig.11 Transient Thermal Response Curve

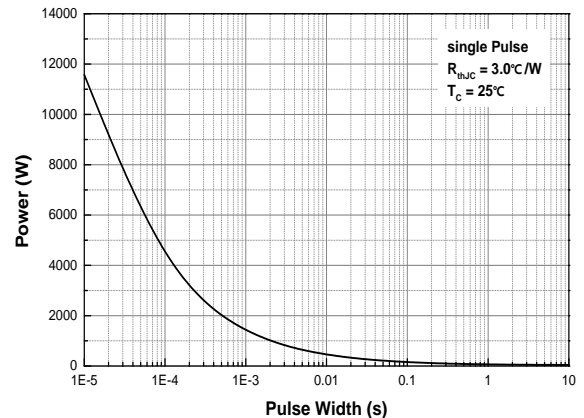
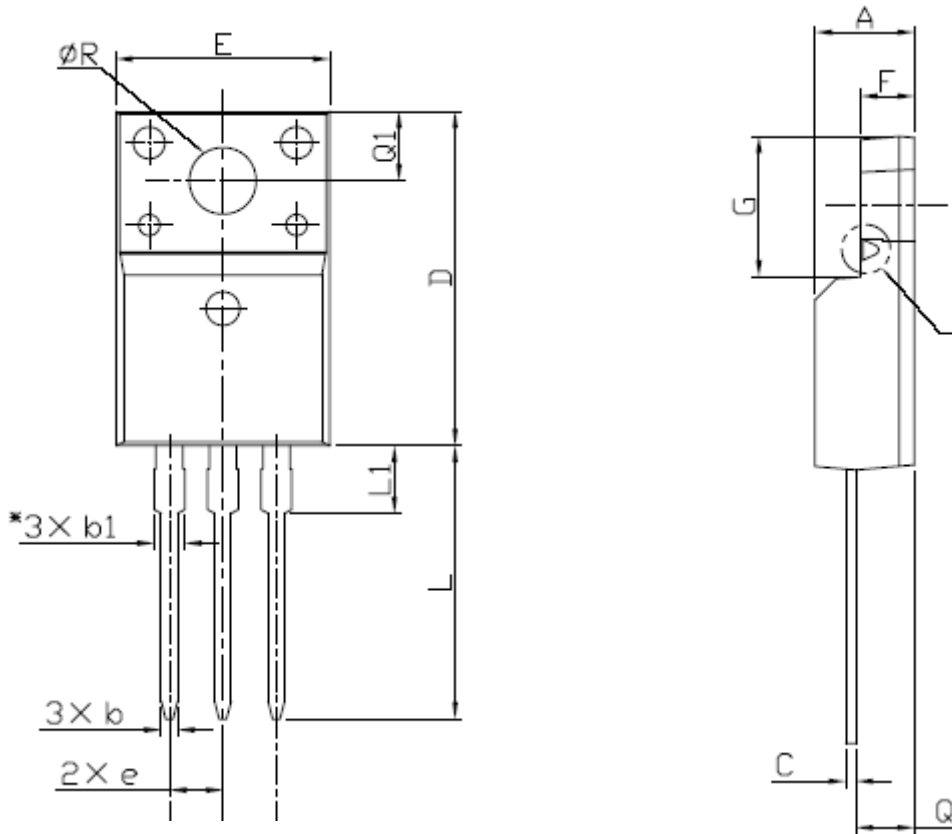

Fig.12 Single Pulse Maximum Power Dissipation

Physical Dimensions

TO-220F

Dimensions are in millimeters unless otherwise specified



Symbol	Min	Nom	Max
A	4.50		4.93
b	0.63		0.91
b1	1.15		1.47
C	0.33		0.63
D	15.47		16.13
E	9.60		10.71
e		2.54	
F	2.34		2.84
G	6.48		6.90
L	12.24		13.72
L1	2.79		3.67
Q	2.52		2.96
Q1	3.10		3.50
ϕR	3.00		3.55

DISCLAIMER:

The Products are not designed for use in hostile environments, including, without limitation, aircraft, nuclear power generation, medical appliances, and devices or systems in which malfunction of any Product can reasonably be expected to result in a personal injury. Seller's customers using or selling Seller's products for use in such applications do so at their own risk and agree to fully defend and indemnify Seller.

Magnachip reserves the right to change the specifications and circuitry without notice at any time. Magnachip does not consider responsibility for use of any circuitry other than circuitry entirely included in a Magnachip product.  Magnachip is a registered trademark of Magnachip Semiconductor Ltd.

单击下面可查看定价，库存，交付和生命周期等信息

[>>MAGNACHIP\(美格纳\)](#)