

### General Description

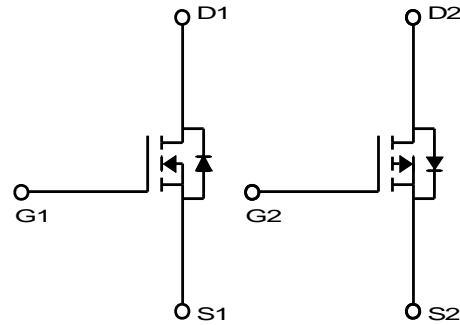
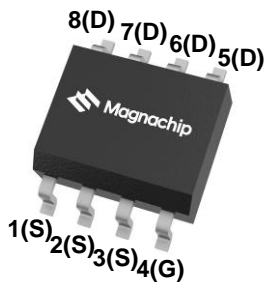
The MDS9651 uses advanced Magnachip's MOSFET Technology to provide low on-state resistance, high switching performance and excellent reliability

### Features

- |  |   |
|--|---|
| <b>N-Channel</b> <ul style="list-style-type: none"> <li>▫ <math>V_{DS} = 30V</math></li> <li>▫ <math>I_D = 6.9A @ V_{GS} = 10V</math></li> <li>▫ <math>R_{DS(ON)} &lt; 28m\Omega @ V_{GS} = 10V</math></li> <li>▫ <math>&lt; 42m\Omega @ V_{GS} = 4.5V</math></li> </ul> | <b>P-Channel</b> <ul style="list-style-type: none"> <li><math>V_{DS} = -30V</math></li> <li><math>I_D = -6.0A @ V_{GS} = -10V</math></li> <li><math>R_{DS(ON)} &lt; 35m\Omega @ V_{GS} = -10V</math></li> <li><math>&lt; 55m\Omega @ V_{GS} = -4.5V</math></li> </ul> |
|--|---|

### Applications

- Inverters
- General purpose applications



### Absolute Maximum Ratings ( $T_a = 25^\circ C$ unless otherwise noted)

Characteristics	Symbol	Rating		Unit	
		N-Ch	P-Ch		
Drain-Source Voltage	$V_{DSS}$	30	-30	V	
Gate-Source Voltage	$V_{GSS}$	$\pm 20$	$\pm 20$	V	
Continuous Drain Current	$I_D$	$T_a = 25^\circ C$	6.9	-6.0	A
		$T_a = 100^\circ C$	4.3	-4.1	A
Pulsed Drain Current	$I_{DM}$	30	-30	A	
Power Dissipation <sup>(1)</sup>	$P_D$	$T_a = 25^\circ C$	2	2	W
		$T_a = 100^\circ C$	0.8	0.8	W
Single Pulse Avalanche Energy <sup>(2)</sup>	$E_{AS}$	18	60.5	mJ	
Junction and Storage Temperature Range	$T_J, T_{sig}$	-55~150		$^\circ C$	

### Thermal Characteristics

Characteristics	Device	Symbol	Rating	Unit
Thermal Resistance, Junction-to-Ambient(Steady-State) <sup>(1)</sup>	N-Ch	$R_{\theta JA}$	62.5	$^\circ C/W$
Thermal Resistance, Junction-to-Case	N-Ch	$R_{\theta JC}$	60	
Thermal Resistance, Junction-to-Ambient(Steady-State) <sup>(1)</sup>	P-Ch	$R_{\theta JA}$	62.5	
Thermal Resistance, Junction-to-Case	P-Ch	$R_{\theta JC}$	40	

## Ordering Information

Part Number	Temp. Range	Package	Packing	RoHS Status
MDS9651URH	-55~150°C	SOIC-8	Tape & Reel	Halogen Free

## N-channel Electrical Characteristics (T<sub>a</sub> = 25°C unless otherwise noted)

Characteristics	Symbol	Test Condition	Min	Typ	Max	Unit
<b>Static Characteristics</b>						
Drain-Source Breakdown Voltage	BV <sub>DSS</sub>	I <sub>D</sub> = 250μA, V <sub>GS</sub> = 0V	30	-	-	V
Gate Threshold Voltage	V <sub>GS(th)</sub>	V <sub>DS</sub> = V <sub>GS</sub> , I <sub>D</sub> = 250μA	1.0	1.9	3.0	
Drain Cut-Off Current	I <sub>DSS</sub>	V <sub>DS</sub> = 24V, V <sub>GS</sub> = 0V	-		1.0	μA
Gate Leakage Current	I <sub>GSS</sub>	V <sub>GS</sub> = ±20V, V <sub>DS</sub> = 0V	-	-	0.1	
Drain-Source ON Resistance	R <sub>DS(ON)</sub>	V <sub>GS</sub> = 10V, I <sub>D</sub> = 6.9A	-	21.5	28.0	mΩ
		V <sub>GS</sub> = 4.5V, I <sub>D</sub> = 5.0A	-	31.5	42.0	
Forward Transconductance	g <sub>FS</sub>	V <sub>DS</sub> = 5V, I <sub>D</sub> = 6.9A	-	15.4	-	S
<b>Dynamic Characteristics</b>						
Total Gate Charge	Q <sub>g</sub>	V <sub>DS</sub> = 15V, I <sub>D</sub> = 6.9A, V <sub>GS</sub> = 10V	-	6.94	-	nC
Gate-Source Charge	Q <sub>gs</sub>		-	1.54	-	
Gate-Drain Charge	Q <sub>gd</sub>		-	1.96	-	
Input Capacitance	C <sub>iss</sub>	V <sub>DS</sub> = 15V, V <sub>GS</sub> = 0V, f = 1.0MHz	-	334	-	pF
Reverse Transfer Capacitance	C <sub>rss</sub>		-	48	-	
Output Capacitance	C <sub>oss</sub>		-	83	-	
Turn-On Delay Time	t <sub>d(on)</sub>	V <sub>GS</sub> = 10V, V <sub>DS</sub> = 15V, R <sub>L</sub> = 2.2Ω, R <sub>GEN</sub> = 3Ω	-	3.5	-	ns
Turn-On Rise Time	t <sub>r</sub>		-	25.4	-	
Turn-Off Delay Time	t <sub>d(off)</sub>		-	14.2	-	
Turn-Off Fall Time	t <sub>f</sub>		-	10.5	-	
<b>Drain-Source Body Diode Characteristics</b>						
Source-Drain Diode Forward Voltage	V <sub>SD</sub>	I <sub>S</sub> = 1A, V <sub>GS</sub> = 0V	-	0.75	1.0	V
Body Diode Reverse Recovery Time	t <sub>rr</sub>	I <sub>F</sub> = 6.9A, di/dt = 100A/μs	-	16.5	-	ns
Body Diode Reverse Recovery Charge	Q <sub>rr</sub>		-	7.8	-	nC

Note :

- Surface mounted FR-4 board with 2oz. Copper.
- Starting T<sub>J</sub> = 25°C, L = 1mH, I<sub>AS</sub> = 6A, V<sub>DD</sub> = 15V, V<sub>GS</sub> = 10V

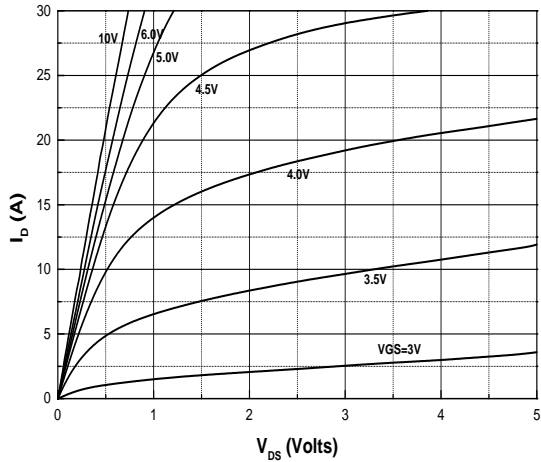
**P-channel Electrical Characteristics (T<sub>a</sub> =25°C unless otherwise noted)**

Characteristics	Symbol	Test Condition	Min	Typ	Max	Unit
<b>Static Characteristics</b>						
Drain-Source Breakdown Voltage	BV <sub>DSS</sub>	I <sub>D</sub> = -250μA, V <sub>GS</sub> = 0V	-30	-	-	V
Gate Threshold Voltage	V <sub>GS(th)</sub>	V <sub>DS</sub> = V <sub>GS</sub> , I <sub>D</sub> = -250μA	-1.0	-1.9	-3.0	
Drain Cut-Off Current	I <sub>DSS</sub>	V <sub>DS</sub> = -24V, V <sub>GS</sub> = 0V	-	-	-1.0	μA
Gate Leakage Current	I <sub>GSS</sub>	V <sub>GS</sub> = ±20V, V <sub>DS</sub> = 0V	-	-	±0.1	
Drain-Source ON Resistance	R <sub>DS(ON)</sub>	V <sub>GS</sub> = -10V, I <sub>D</sub> = -6.0A	-	30.5	35.0	mΩ
		V <sub>GS</sub> = -4.5V, I <sub>D</sub> = -5.0A	-	41.5	55.0	
Forward Transconductance	g <sub>FS</sub>	V <sub>DS</sub> = -5V, I <sub>D</sub> = -6.0A	-	13	-	S
<b>Dynamic Characteristics</b>						
Total Gate Charge	Q <sub>g</sub>	V <sub>DS</sub> = -15V, I <sub>D</sub> = -6.0A, V <sub>GS</sub> = -10V	-	18.4	-	nC
Gate-Source Charge	Q <sub>gs</sub>		-	3.1	-	
Gate-Drain Charge	Q <sub>gd</sub>		-	3.6	-	
Input Capacitance	C <sub>iss</sub>	V <sub>DS</sub> = -15V, V <sub>GS</sub> = 0V, f = 1.0MHz	-	874	-	pF
Reverse Transfer Capacitance	C <sub>rss</sub>		-	103	-	
Output Capacitance	C <sub>oss</sub>		-	166	-	
Turn-On Delay Time	t <sub>d(on)</sub>	V <sub>GS</sub> = -10V, V <sub>DS</sub> = -15V, R <sub>L</sub> = 2.7Ω, R <sub>GEN</sub> = 3Ω	-	9.8	-	ns
Turn-On Rise Time	t <sub>r</sub>		-	29.8	-	
Turn-Off Delay Time	t <sub>d(off)</sub>		-	26.3	-	
Turn-Off Fall Time	t <sub>f</sub>		-	8.6	-	
<b>Drain-Source Body Diode Characteristics</b>						
Source-Drain Diode Forward Voltage	V <sub>SD</sub>	I <sub>S</sub> = -1A, V <sub>GS</sub> = 0V	-	-0.75	-1.0	V
Body Diode Reverse Recovery Time	t <sub>rr</sub>	I <sub>F</sub> = -6.0A, di/dt = 100A/μs	-	20	-	ns
Body Diode Reverse Recovery Charge	Q <sub>rr</sub>		-	12.3	-	nC

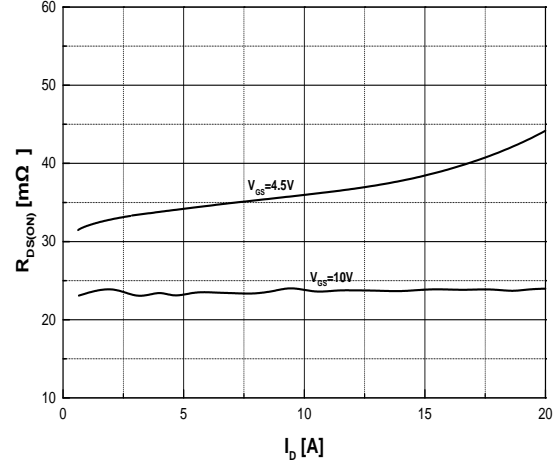
Note :

1. Surface mounted RF4 board with 2oz. Copper.
2. Starting T<sub>J</sub> = 25°C, L = 1mH, I<sub>AS</sub> = -11A, V<sub>DD</sub> = -15V, V<sub>GS</sub> = -10V

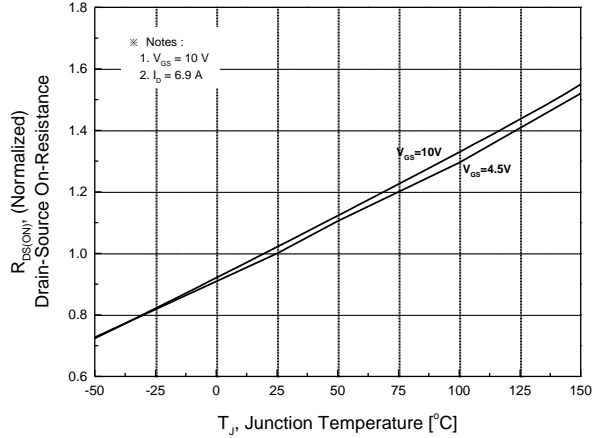
**N-CHANNEL TYPICAL ELECTRICAL AND THERMAL CHARACTERISTICS**



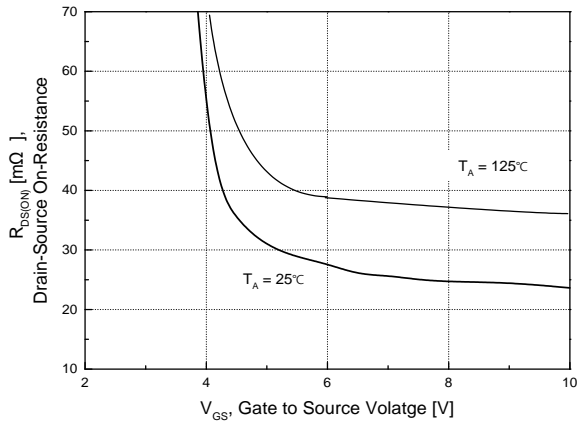
**Fig.1 On-Region Characteristics**



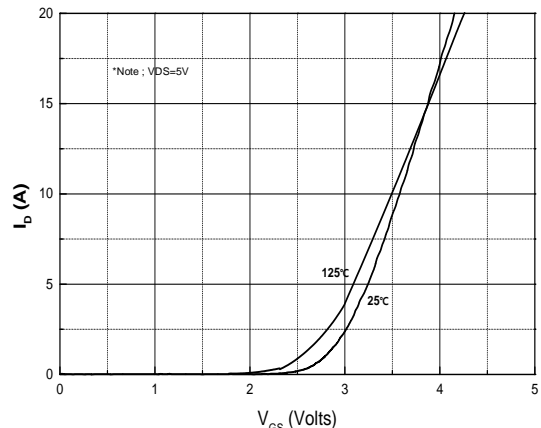
**Fig.2 On-Resistance Variation with Drain Current and Gate Voltage**



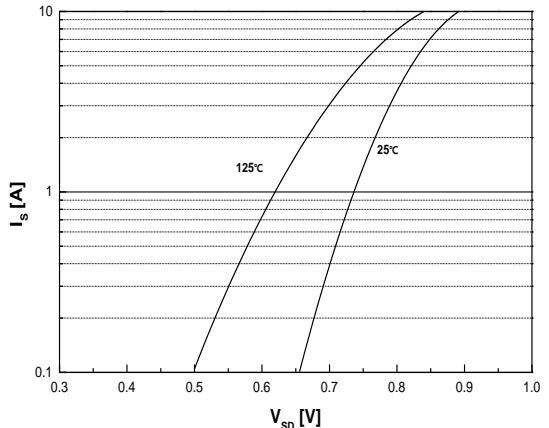
**Fig.3 On-Resistance Variation with Temperature**



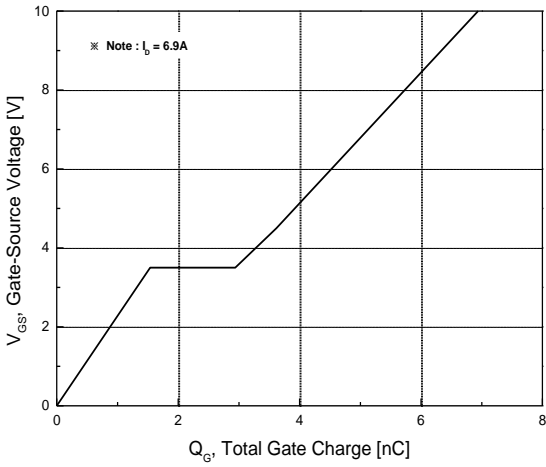
**Fig.4 On-Resistance Variation with Gate to Source Voltage**



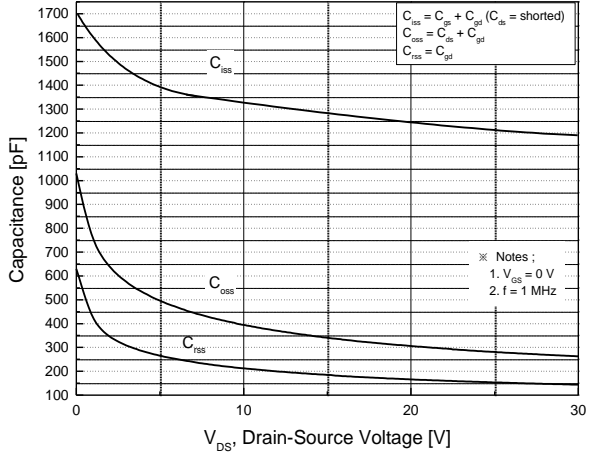
**Fig.5 Transfer Characteristics**



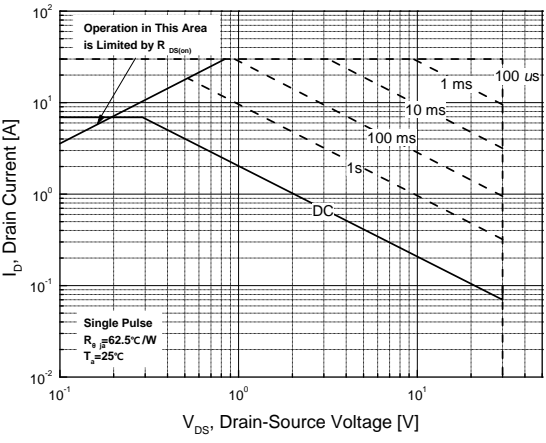
**Fig.6 Body Diode Forward Voltage Variation with Source Current and Temperature**



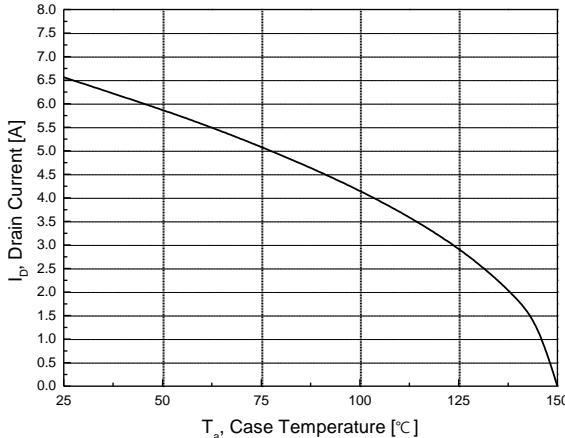
**Fig.7 Gate Charge Characteristics**



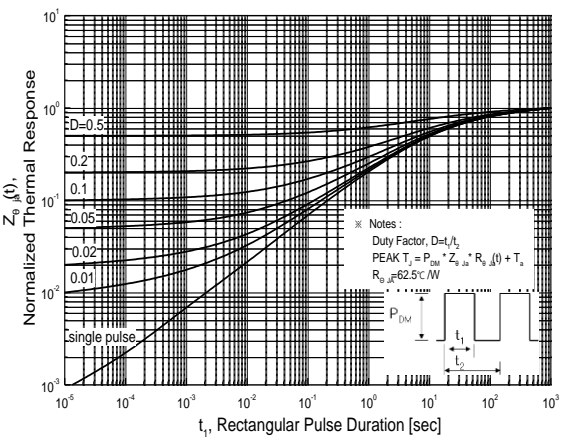
**Fig.8 Capacitance Characteristics**



**Fig.9 Maximum Safe Operating Area**

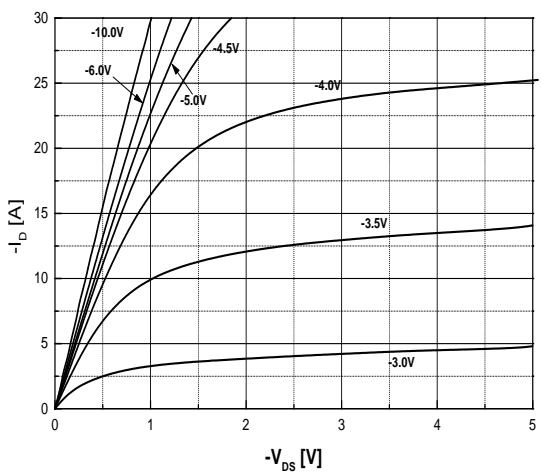


**Fig.10 Maximum Drain Current Vs. Case Temperature**

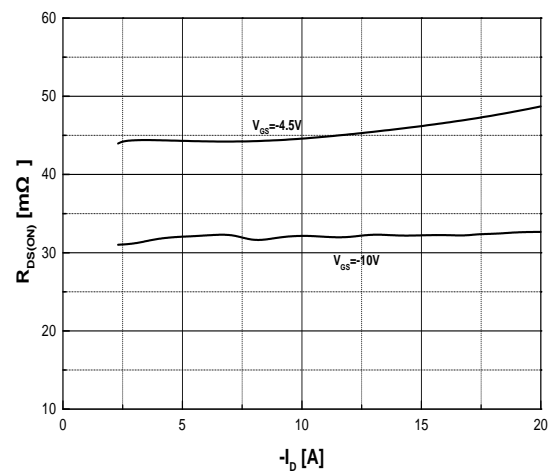


**Fig.11 Transient Thermal Response Curve**

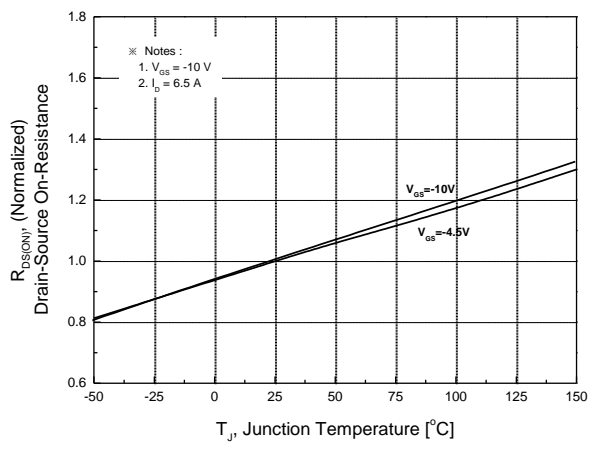
**P-CHANNEL TYPICAL ELECTRICAL AND THERMAL CHARACTERISTICS**



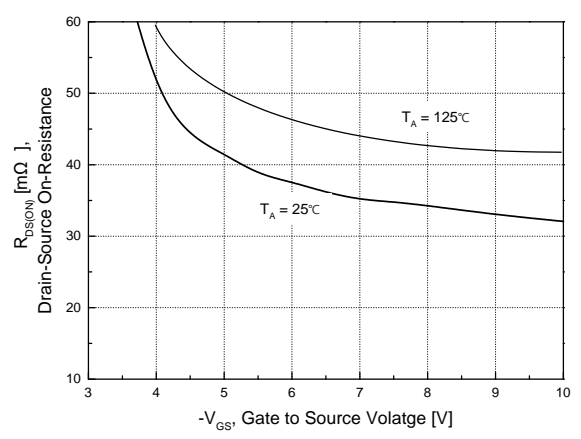
**Fig.1 On-Region Characteristics**



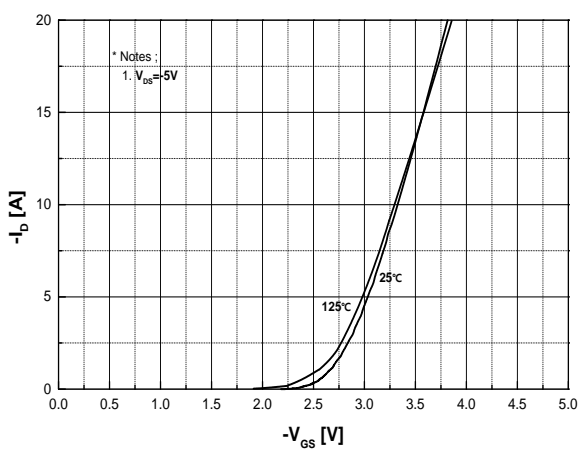
**Fig.2 On-Resistance Variation with Drain Current and Gate Voltage**



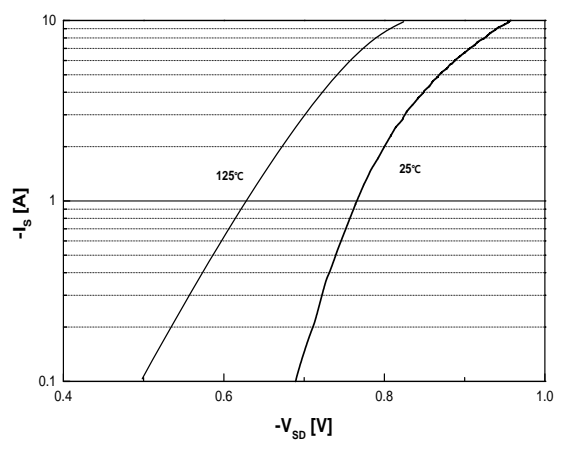
**Fig.3 On-Resistance Variation with Temperature**



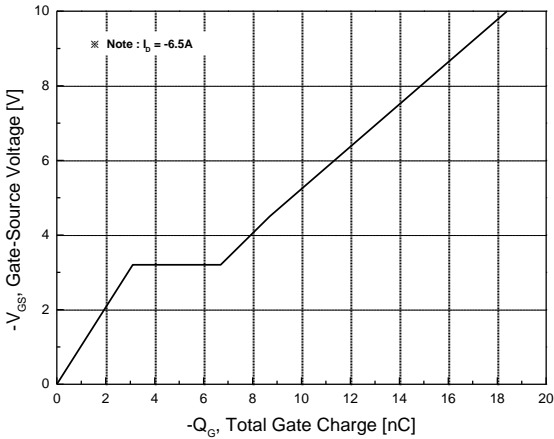
**Fig.4 On-Resistance Variation with Gate to Source Voltage**



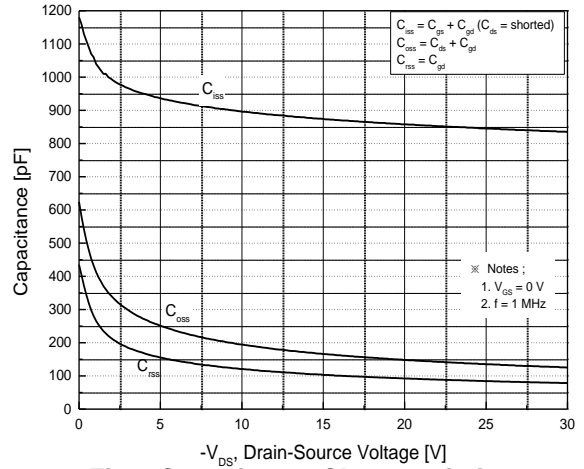
**Fig.5 Transfer Characteristics**



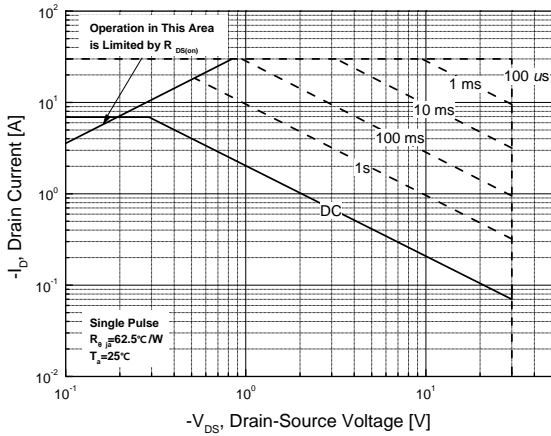
**Fig.6 Body Diode Forward Voltage Variation with Source Current and Temperature**



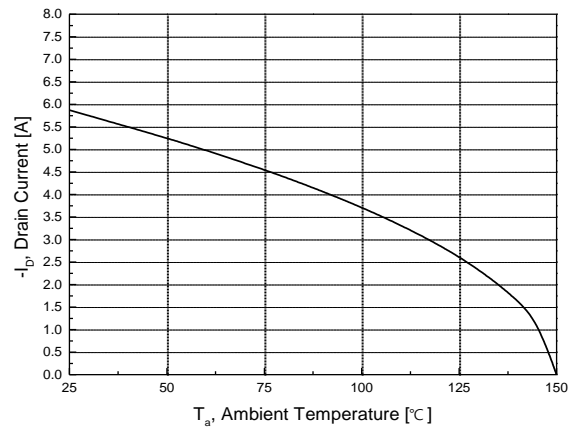
**Fig.7 Gate Charge Characteristics**



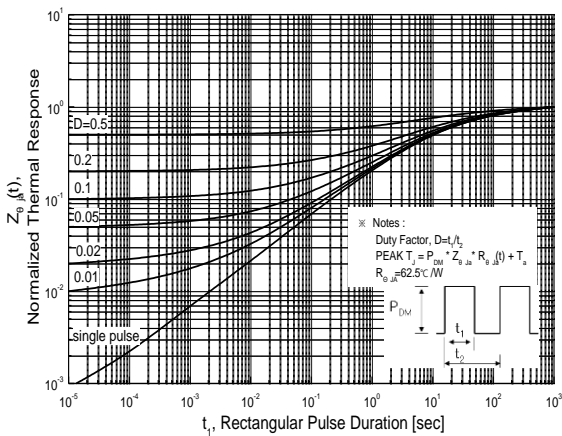
**Fig.8 Capacitance Characteristics**



**Fig.9 Maximum Safe Operating Area**



**Fig.10 Maximum Drain Current vs. Case Temperature**

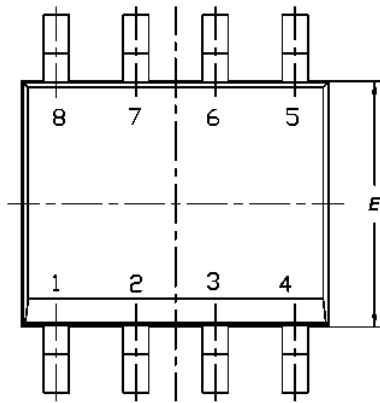


**Fig.11 Transient Thermal Response Curve**

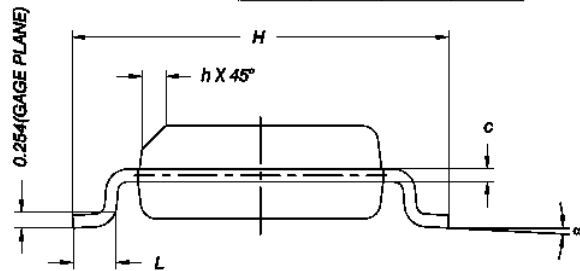
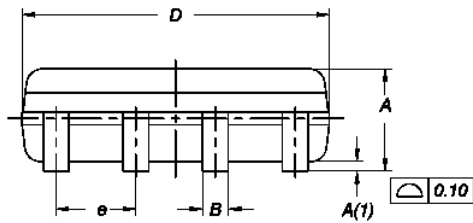
## Physical Dimensions

### SOIC-8L

Dimensions are in millimeters unless otherwise specified



DIM.	MILLIMETERS		
	MIN.	NOM.	MAX.
A	1.35	1.55	1.75
A(1)	0.10	0.175	0.25
B	0.38	0.445	0.51
C	0.19	0.22	0.25
D	4.80	4.90	5.00
E	3.80	3.90	4.00
e	1.27 BSC		
H	5.80	6.00	6.20
L	0.50	0.715	0.93
$\alpha$	0°	4°	8°
h	0.25	0.375	0.50




Note : Package body size, length and width do not include mold flash, protrusions and gate burrs.



**DISCLAIMER:**

The Products are not designed for use in hostile environments, including, without limitation, aircraft, nuclear power generation, medical appliances, and devices or systems in which malfunction of any Product can reasonably be expected to result in a personal injury. Seller's customers using or selling Seller's products for use in such applications do so at their own risk and agree to fully defend and indemnify Seller.

Magnachip reserves the right to change the specifications and circuitry without notice at any time. Magnachip does not consider responsibility for use of any circuitry other than circuitry entirely included in a Magnachip product.  Magnachip is a registered trademark of Magnachip Semiconductor Ltd.

单击下面可查看定价，库存，交付和生命周期等信息

[>>MAGNACHIP\(美格纳\)](#)