

General Description

The MDE1752 uses advanced Magnachip's trench MOSFET Technology to provide high performance in on-state resistance, switching performance and reliability

Low $R_{DS(ON)}$, low gate charge can be offering superior benefit in the application.

Features

- $V_{DS} = 40V$
- $I_D = 66A$ @ $V_{GS} = 10V$
- $R_{DS(ON)} < 8.0m\Omega$ @ $V_{GS} = 10V$
- $< 10.5m\Omega$ @ $V_{GS} = 4.5V$

Applications

- Inverters
- General purpose applications

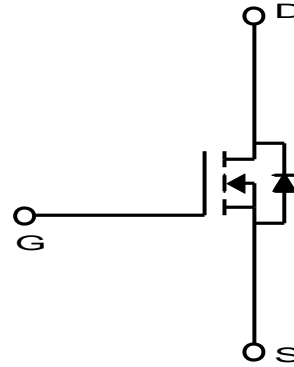
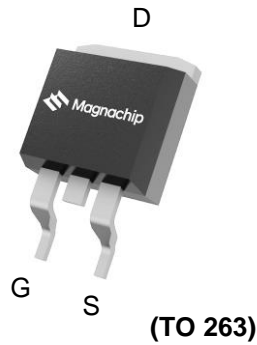

Absolute Maximum Ratings ($T_C = 25^\circ C$ unless otherwise noted)

Characteristics		Symbol	Rating	Unit
Drain-Source Voltage		V_{DSS}	40	V
Gate-Source Voltage		V_{GSS}	± 20	V
Continuous Drain Current	(Note 2) $T_C = 25^\circ C$	I_D	66	A
Pulsed Drain Current		I_{DM}	100	A
Power Dissipation for Single Operation	$T_C = 25^\circ C$	P_D	60	W
	$T_A = 25^\circ C$		3.1	
Single Pulse Avalanche Energy		(Note 3) E_{AS}	153	mJ
Junction and Storage Temperature Range		T_J, T_{stg}	-55~+150	$^\circ C$

Thermal Characteristics

Characteristics		Symbol	Rating	Unit
Thermal Resistance, Junction-to-Ambient	(Note 1)	$R_{\theta JA}$	40	$^\circ C/W$
Thermal Resistance, Junction-to-Case		$R_{\theta JC}$	2.1	

Ordering Information

Part Number	Temp. Range	Package	Packing	RoHS Status
MDE1752RH	-55~150°C	TO-263	Tape & Reel	Halogen Free

Electrical Characteristics (T_J =25°C unless otherwise noted)

Characteristics	Symbol	Test Condition	Min	Typ	Max	Unit
Static Characteristics						
Drain-Source Breakdown Voltage	BV _{DSS}	I _D = 250μA, V _{GS} = 0V	40	-	-	V
Gate Threshold Voltage	V _{GS(th)}	V _{DS} = V _{GS} , I _D = 250μA	1.0	1.7	3.0	
Zero Gate Voltage Drain Current	I _{DSS}	V _{DS} = 32V, V _{GS} = 0V	-	-	1	μA
Gate Leakage Current	I _{GSS}	V _{GS} = ±20V, V _{DS} = 0V	-	-	0.1	
Drain-Source ON Resistance	R _{DS(on)}	V _{GS} = 10V, I _D = 14A	-	6.1	8.0	mΩ
		V _{GS} = 4.5V, I _D = 11A	-	8.2	10.5	
Forward Transconductance	g _{FS}	V _{DS} = 5V, I _D = 14A	-	58	-	S
Dynamic Characteristics						
Total Gate Charge	Q _g	V _{DS} = 20V, I _D = 14A, V _{GS} = 10V	-	26.4	-	nC
Gate-Source Charge	Q _{gs}		-	3.6	-	
Gate-Drain Charge	Q _{gd}		-	6.8	-	
Input Capacitance	C _{iss}	V _{DS} = 20V, V _{GS} = 0V, f = 1.0MHz	-	1480	-	pF
Reverse Transfer Capacitance	C _{rss}		-	113	-	
Output Capacitance	C _{oss}		-	243	-	
Turn-On Delay Time	t _{d(on)}	V _{GS} = 10V, V _{DS} = 20V, I _D = 1A, R _{GEN} = 6Ω	-	9	-	ns
Turn-On Rise Time	t _r		-	21	-	
Turn-Off Delay Time	t _{d(off)}		-	31	-	
Turn-Off Fall Time	t _f		-	18	-	
Drain-Source Body Diode Characteristics						
Source-Drain Diode Forward Voltage	V _{SD}	I _S = 14A, V _{GS} = 0V	-	0.8	1.2	V
Body Diode Reverse Recovery Time	t _{rr}	I _F = 14A, di/dt = 100A/μs	-	26	-	ns
Body Diode Reverse Recovery Charge	Q _{rr}		-	11	-	nC

Note :

- Surface mounted RF4 board with 2oz. Copper.
- P_D is based on T_{J(MAX)}=150°C
P_D (T_C=25°C) is based on R_{θJC},
- Starting T_J=25°C, L=1mH, I_{AS}=17.5A, V_{DD}=40V, V_{GS}=10V

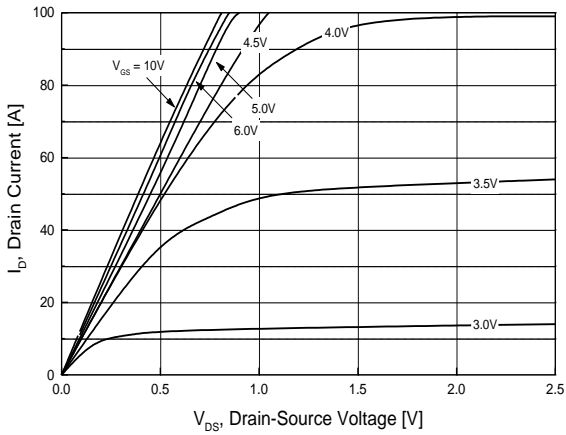

Fig.1 On-Region Characteristics

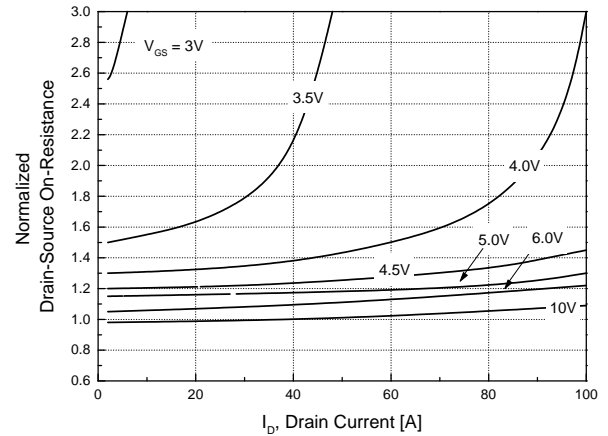

Fig.2 On-Resistance Variation with Drain Current and Gate Voltage

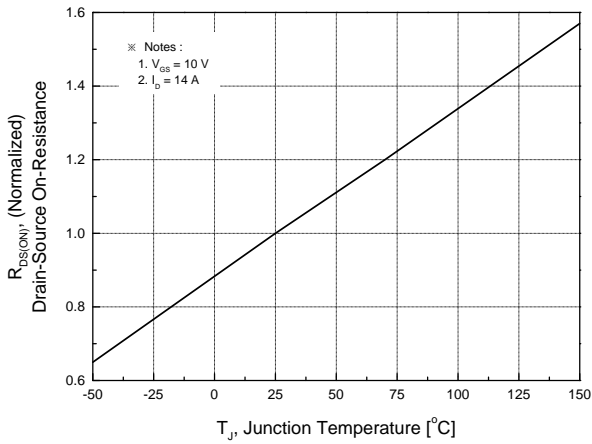

Fig.3 On-Resistance Variation with Temperature

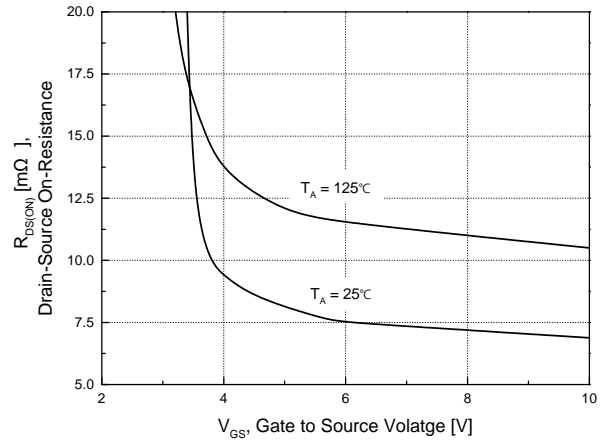

Fig.4 On-Resistance Variation with Gate to Source Voltage

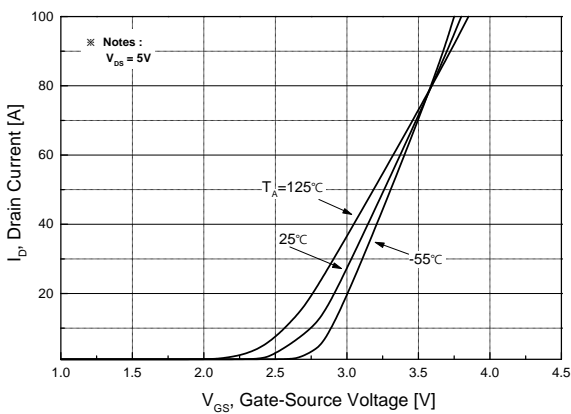

Fig.5 Transfer Characteristics

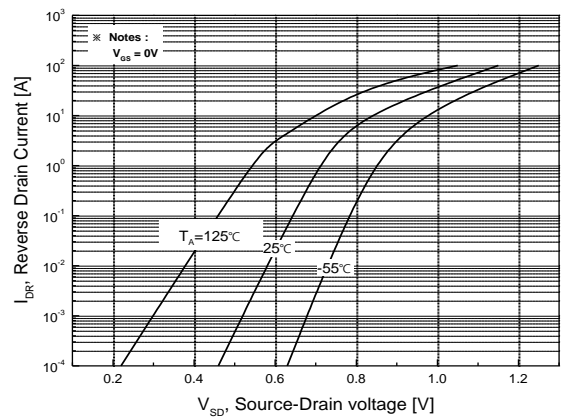
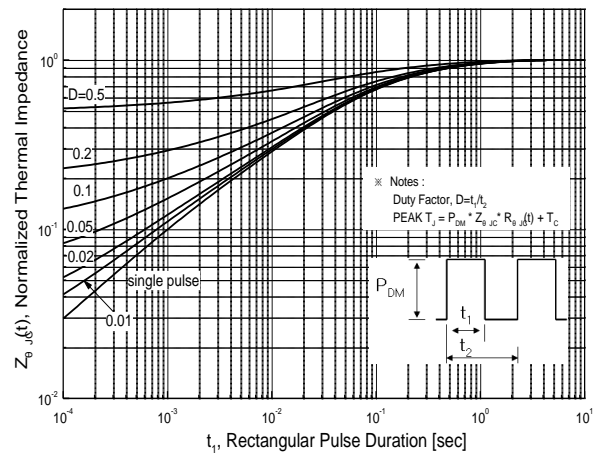
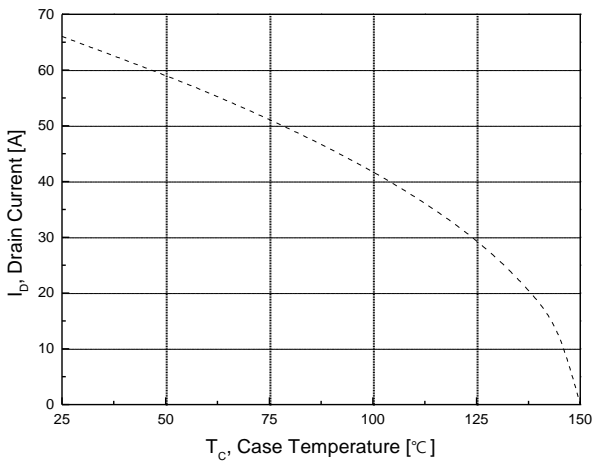
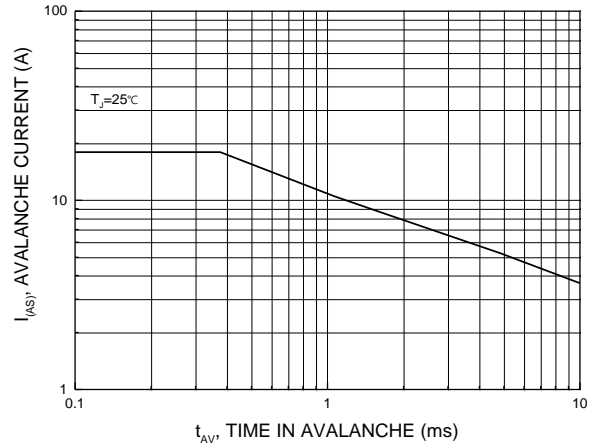
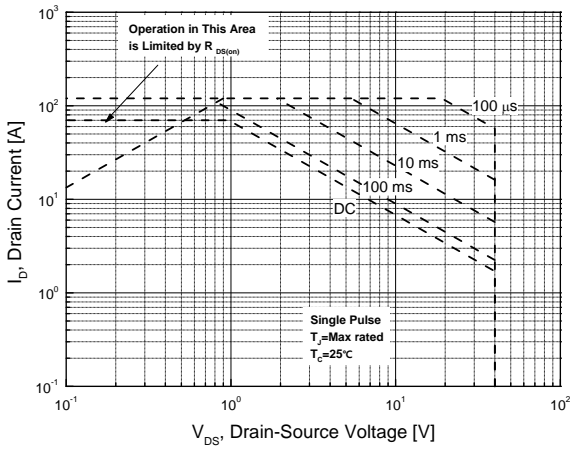
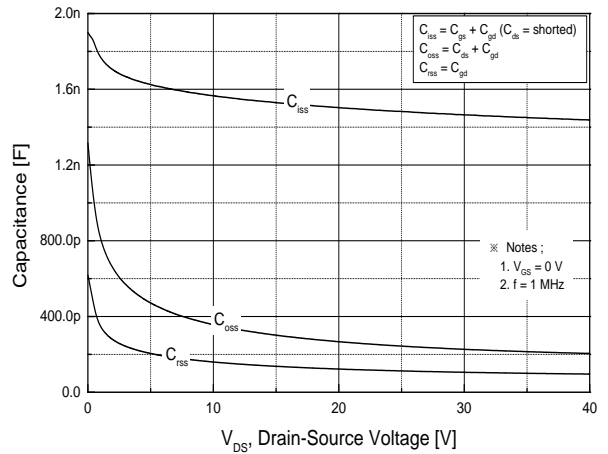
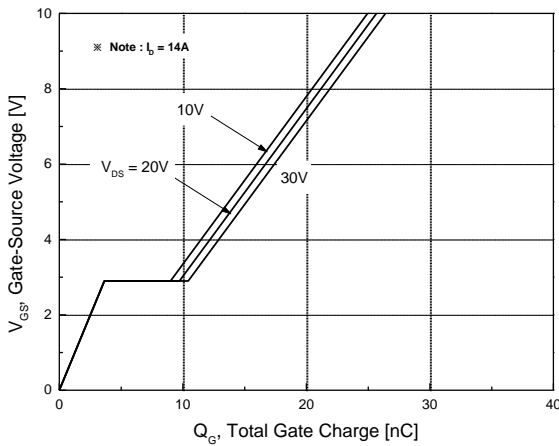

Fig.6 Body Diode Forward Voltage Variation with Source Current and Temperature



Physical Dimension

TO-263 (D2PAK)

Dimensions are in millimeters unless otherwise specified

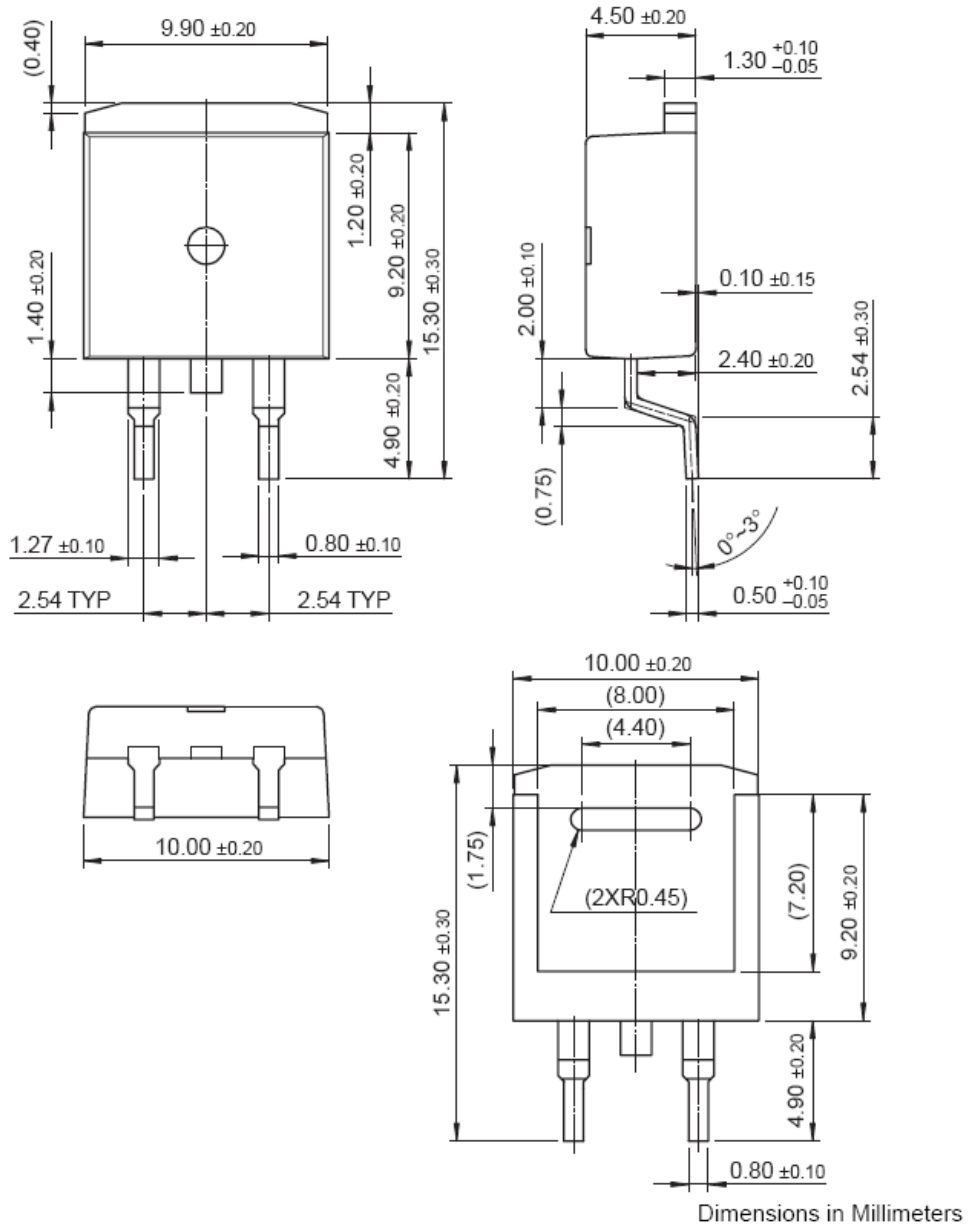

Note : Package body size, length and width do not include mold flash, protrusions and gate burrs.

DISCLAIMER:

The Products are not designed for use in hostile environments, including, without limitation, aircraft, nuclear power generation, medical appliances, and devices or systems in which malfunction of any Product can reasonably be expected to result in a personal injury. Seller's customers using or selling Seller's products for use in such applications do so at their own risk and agree to fully defend and indemnify Seller.

Magnachip reserves the right to change the specifications and circuitry without notice at any time. Magnachip does not consider responsibility for use of any circuitry other than circuitry entirely included in a Magnachip product.  Magnachip is a registered trademark of Magnachip Semiconductor Ltd.

单击下面可查看定价，库存，交付和生命周期等信息

[>>MAGNACHIP\(美格纳\)](#)