

General Description

The MDS5601 uses advanced Magnachip's MOSFET Technology, which provides high performance in on-state resistance, fast switching performance and excellent quality. MDS5601 is suitable for DC/DC converter and general purpose applications.

Features

- $V_{DS} = 30V$
- $I_D = 12.9A$ @ $V_{GS} = 10V$
- $R_{DS(ON)} < 10.5m\Omega$ @ $V_{GS} = 10V$
 $< 16.1m\Omega$ @ $V_{GS} = 4.5V$
- 100% UIL Tested
- 100% Rg Tested

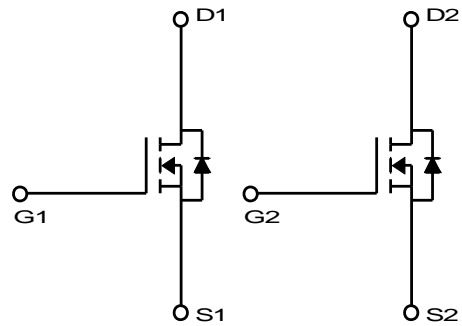
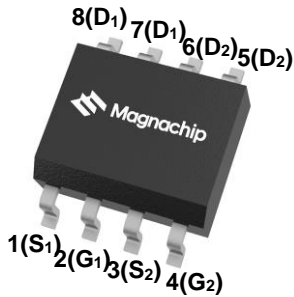

Absolute Maximum Ratings (Ta = 25°C)

Characteristics		Symbol	Rating	Unit
Drain-Source Voltage		V_{DSS}	30	V
Gate-Source Voltage		V_{GSS}	±20	V
Continuous Drain Current ⁽¹⁾	$T_C=25^\circ C$	I_D	12.9	A
	$T_C=70^\circ C$		10.4	
	$T_A=25^\circ C$		10.0 ⁽³⁾	
	$T_A=70^\circ C$		8.0 ⁽³⁾	
Pulsed Drain Current		I_{DM}	40	A
Power Dissipation	$T_C=25^\circ C$	P_D	3.13	W
	$T_C=70^\circ C$		2.0	
	$T_A=25^\circ C$		2.0 ⁽³⁾	
	$T_A=70^\circ C$		1.28 ⁽³⁾	
Single Pulse Avalanche Energy ⁽²⁾		E_{AS}	32	mJ
Junction and Storage Temperature Range		T_J, T_{stg}	-55~150	°C

Thermal Characteristics

Characteristics	Symbol	Rating	Unit
Thermal Resistance, Junction-to-Ambient ⁽¹⁾	$R_{\theta JA}$	62.5	°C/W
Thermal Resistance, Junction-to-Case	$R_{\theta JC}$	40	

Ordering Information

Part Number	Temp. Range	Package	Packing	Rohs Status
MDS5601URH	-55~150°C	SOIC-8	Tape & Reel	Halogen Free

Electrical Characteristics (T_J = 25°C)

Characteristics	Symbol	Test Condition	Min	Typ	Max	Unit
Static Characteristics						
Drain-Source Breakdown Voltage	BV _{DSS}	I _D = 250μA, V _{GS} = 0V	30	-	-	V
Gate Threshold Voltage	V _{GS(th)}	V _{DS} = V _{GS} , I _D = 250μA	1.3	2.0	2.7	
Drain Cut-Off Current	I _{DSS}	V _{DS} = 30V, V _{GS} = 0V T _J =55°C	-	-	1	μA
Gate Leakage Current	I _{GSS}	V _{GS} = ±20V, V _{DS} = 0V	-	-	±0.1	
Drain-Source ON Resistance	R _{DS(ON)}	V _{GS} = 10V, I _D = 9.0A T _J =125°C	-	9.5	10.5	mΩ
		V _{GS} = 4.5V, I _D = 7.0A	-	13.1	16.1	
Forward Transconductance	g _{fs}	V _{DS} = 10V, I _D = 9A	-	35	-	S
Dynamic Characteristics						
Total Gate Charge	Q _{g(10V)}	V _{DS} = 15.0V, I _D = 9.0A, V _{GS} = 10V	11.0	15.7	-20.4	nC
Total Gate Charge	Q _{g(4.5V)}		5.4	7.7	10.0	
Gate-Source Charge	Q _{gs}		-	3.4	-	
Gate-Drain Charge	Q _{gd}		-	2.5	-	
Input Capacitance	C _{iss}	V _{DS} = 15.0V, V _{GS} = 0V, f = 1.0MHz	682	975	1268	pF
Reverse Transfer Capacitance	C _{rss}		98	97	126	
Output Capacitance	C _{oss}		143	204		
Turn-On Delay Time	t _{d(on)}	V _{GS} = 10V, V _{DS} = 15.0V, R _L = 1.5Ω, R _G = 3.0Ω	-	5.9	-	ns
Rise Time	t _r		-	21.3	-	
Turn-Off Delay Time	t _{d(off)}		-	21.4	-	
Fall Time	t _f		-	12.4	-	
Gate Resistance	R _g	f=1 MHz	-	1.6	3.0	Ω
Drain-Source Body Diode Characteristics						
Source-Drain Diode Forward Voltage	V _{SD}	I _S = 1.0A, V _{GS} = 0V	-	0.72	1.0	V
Body Diode Reverse Recovery Time	t _{rr}	I _F = 9.0A, di/dt = 100A/μs	-	27.2	-	ns
Body Diode Reverse Recovery Charge	Q _{rr}		-	11.5	-	nC

Note :

- Surface mounted RF4 board with 2oz. Copper. Continuous current at T_C=25°C is silicon limited.
- E_{AS} is tested at starting T_J=25°C, L = 1.0mH, I_{AS} = 8A, V_{DD} = 15V, V_{GS} = 10V.
- T < 10sec.

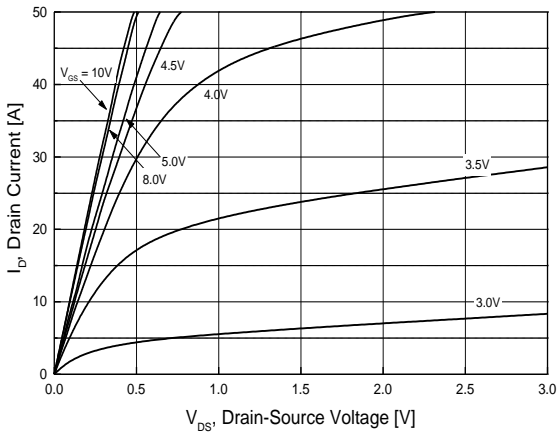

Fig.1 On-Region Characteristics

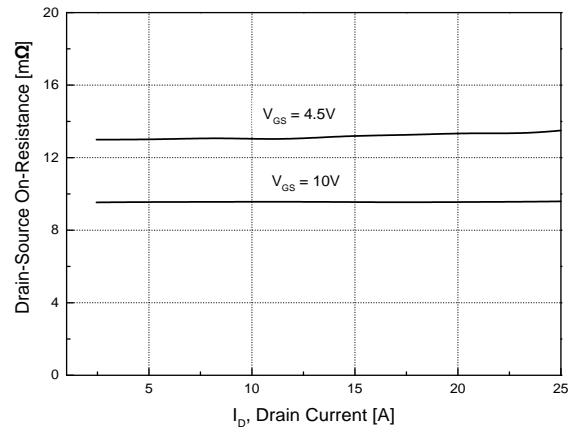

Fig.2 On-Resistance Variation with Drain Current and Gate Voltage

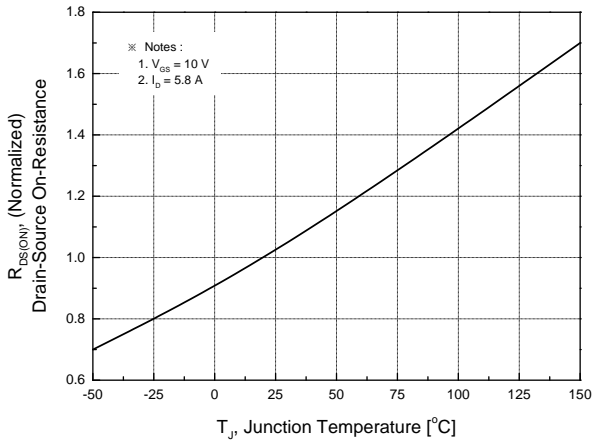

Fig.3 On-Resistance Variation with Junction Temperature

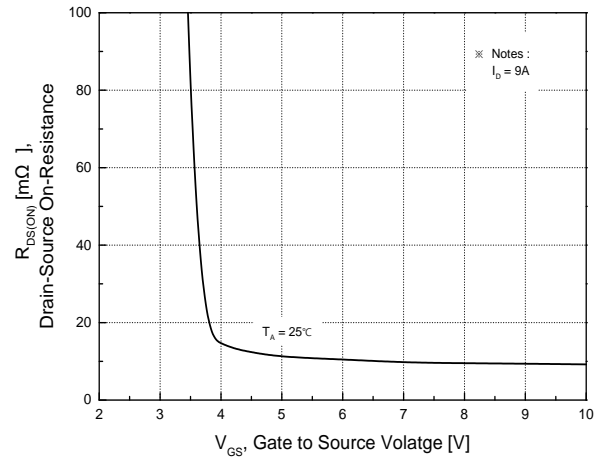

Fig.4 On-Resistance Variation with Gate to Source Voltage

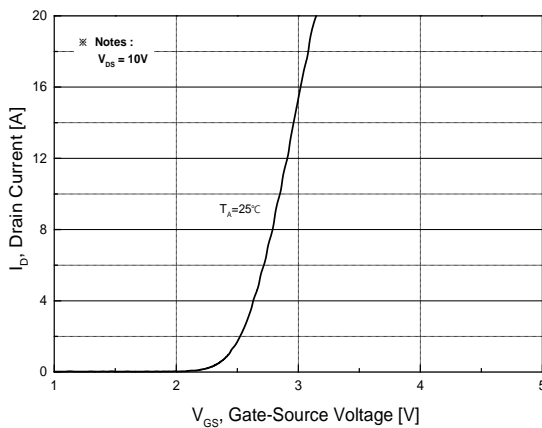

Fig.5 Transfer Characteristics

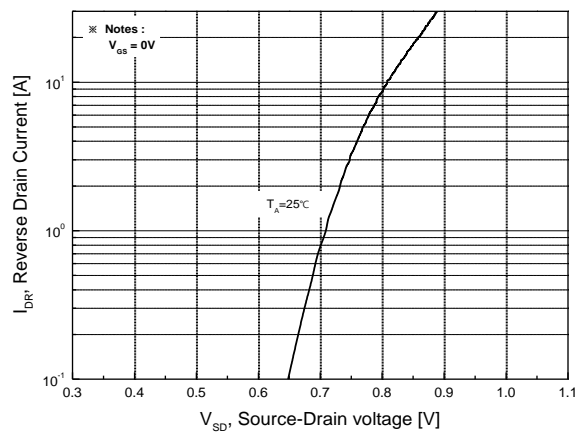

Fig.6 Body Diode Forward Voltage Variation with Source Current and Temperature

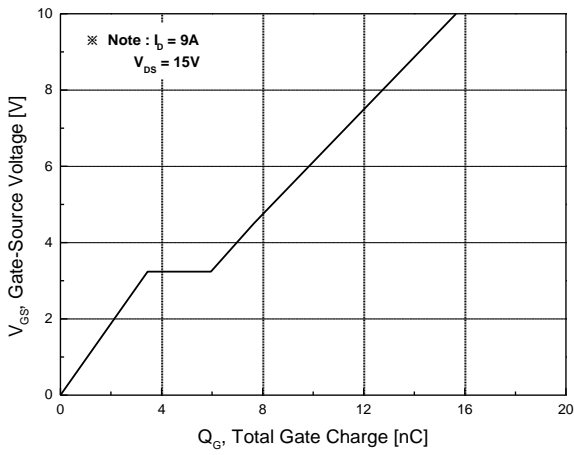

Fig.7 Gate Charge Characteristics

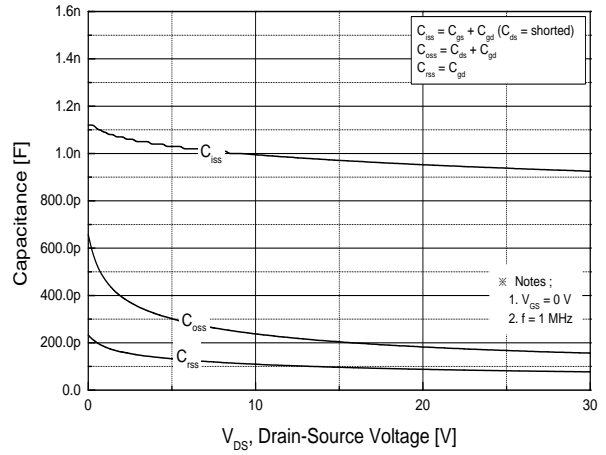

Fig.8 Capacitance Characteristics

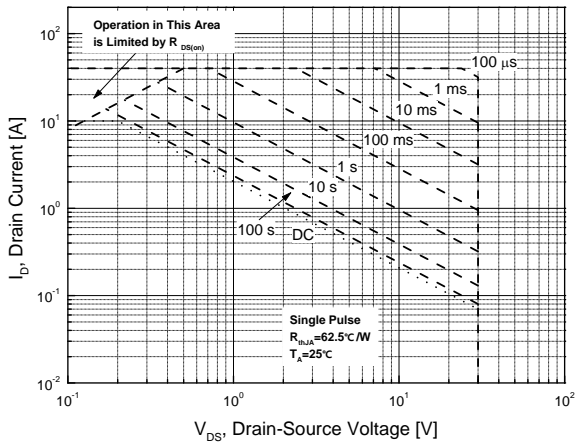

Fig.9 Maximum Safe Operating Area

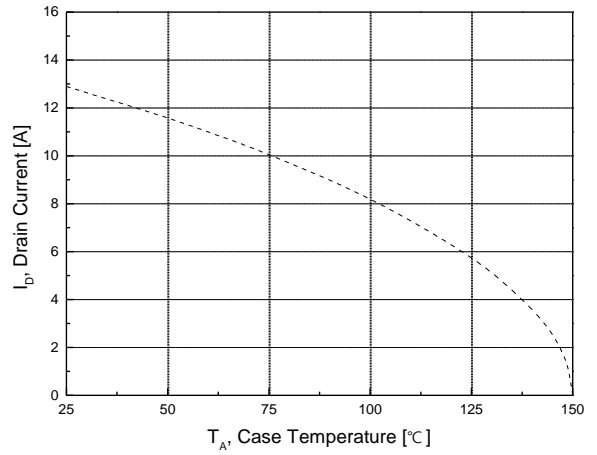

Fig.10 Maximum Drain Current vs. Case Temperature

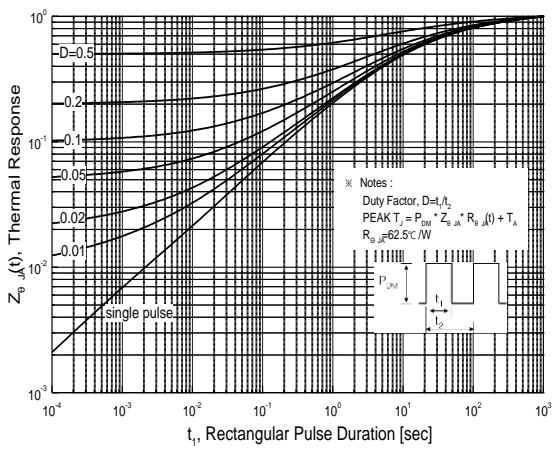
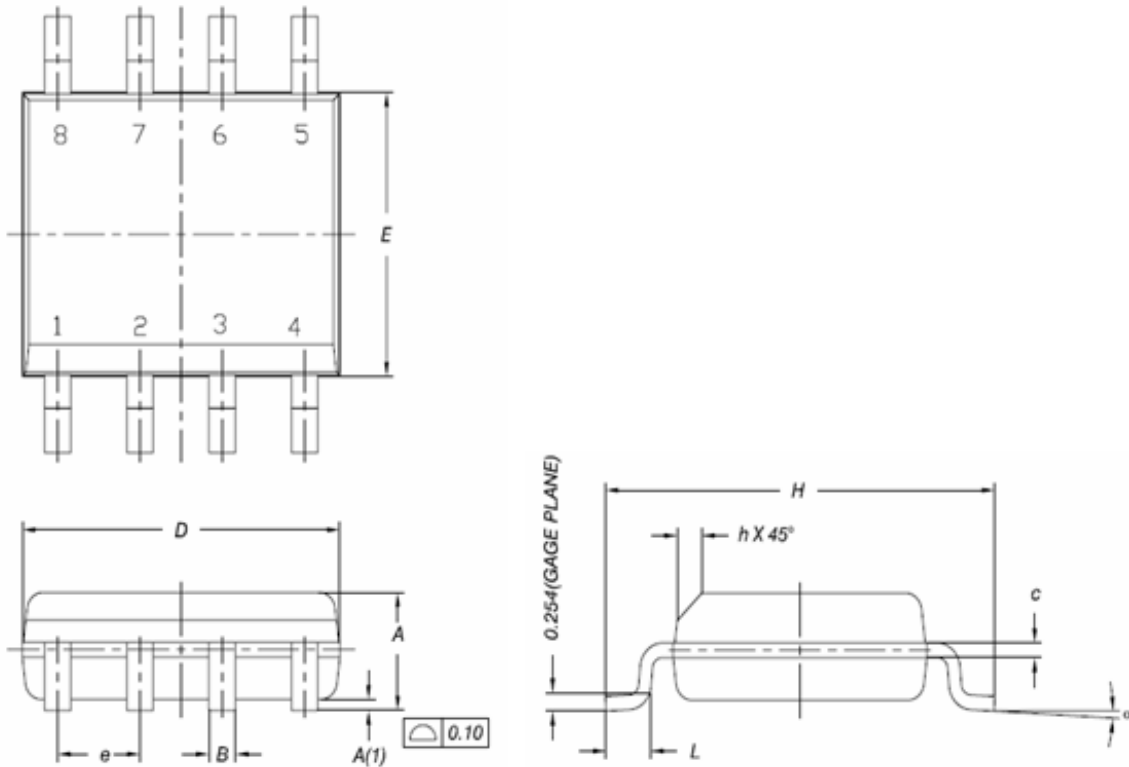

Fig.11 Transient Thermal Response Curve

Physical Dimensions

SOIC-8L

Dimensions are in millimeters unless otherwise specified



Symbol	Min.	Nom.	Max.
A	-	-	1.75
A(1)	0.10	-	0.25
B	0.31	-	0.51
C	0.10	-	0.25
D	-	4.9 BSC	-
E	-	3.9 BSC	-
e	-	1.27 BSC	-
H	-	6.0 BSC	-
L	0.40	-	1.27
a	0	-	8
h	0.250	-	0.500
L2(Gage Plane)	0.25 BSC		

Note : Package body size, length and width do not include mold flash, protrusions and gate burrs.

DISCLAIMER:

The Products are not designed for use in hostile environments, including, without limitation, aircraft, nuclear power generation, medical appliances, and devices or systems in which malfunction of any Product can reasonably be expected to result in a personal injury. Seller's customers using or selling Seller's products for use in such applications do so at their own risk and agree to fully defend and indemnify Seller.

Magnachip reserves the right to change the specifications and circuitry without notice at any time. Magnachip does not consider responsibility for use of any circuitry other than circuitry entirely included in a Magnachip product.  Magnachip is a registered trademark of Magnachip Semiconductor Ltd.

单击下面可查看定价，库存，交付和生命周期等信息

[>>MAGNACHIP\(美格纳\)](#)