

General Description

The MDWC0337E uses advanced Magnachip's MOSFET Technology, which provides high performance in on-state resistance and excellent reliability. Excellent low $R_{SS(ON)}$, low gate charge operation and operation for Battery Application.

Features

- $V_{SS} = 20V$
- Source-Source ON Resistance;
 - $R_{SS(ON)}$ typ. 8.3mΩ @ $V_{GS} = 4.5V$
 - $R_{SS(ON)}$ typ. 8.8mΩ @ $V_{GS} = 3.8V$
 - $R_{SS(ON)}$ typ. 9.9mΩ @ $V_{GS} = 3.1V$
 - $R_{SS(ON)}$ typ. 12.1mΩ @ $V_{GS} = 2.5V$

Applications

- Portable Battery Protection Module

Top View

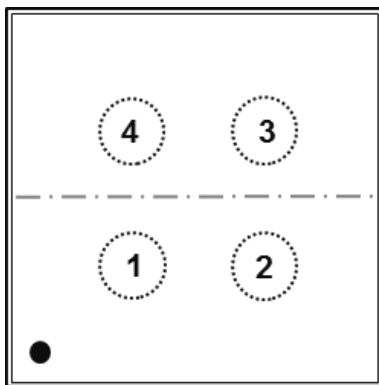

1.88mm*1.88mm WLCSP

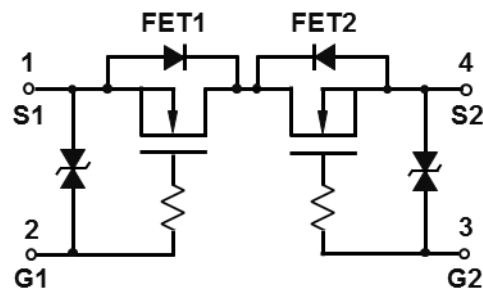

- 1. Source (FET1)
- 2. Gate(FET1)
- 3. Gate(FET2)
- 4. Source(FET2)

Absolute Maximum Ratings ($T_a = 25^\circ C$ unless otherwise noted)

Characteristics		Symbol	Rating	Units
Source-Source Voltage		V_{SSS}	20	V
Gate-Source Voltage		V_{GSS}	±8	V
Source Current	DC ^{*1}	I_S	6.4	A
	Pulse ^{*2}	I_{Sp}	63	A
Total Power Dissipation	DC ^{*1}	PD	0.8	W
Channel Temperature		T_{ch}	150	°C
Junction and Storage Temperature Range		T_J, T_{stg}	-55~150	°C

Thermal Characteristics

Characteristics		Symbol	Rating	Unit
Thermal Resistance	DC ^{*1}	Typ.	121	°C/W
		Max.	157	°C/W

Ordering Information

Part Number	Temp. Range	Package	Packing	RoHS Status
MDWC0337ERH	-55~150°C	WLCSP	Tape and Reel	Halogen Free

Electrical Characteristics (Ta =25°C unless otherwise noted)

Characteristics	Symbol	Test Condition	Min	Typ	Max	Units
Static Characteristics						
Source-Source Breakdown Voltage	BV_{SSS}	$I_S = 500\mu A, V_{GS} = 0V$	20	-	-	V
Gate Threshold Voltage	$V_{GS(th)}$	$V_{SS} = V_{GS}, I_S = 1mA$	0.5	1.0	1.5	
Cut-Off Current	I_{SSS}	$V_{SS} = 20V, V_{GS} = 0V$	-	-	1.0	μA
Gate Leakage Current	I_{GSS}	$V_{GS} = \pm 8V, V_{SS} = 0V$	-	-	10	μA
Source-Source Resistance	$R_{SS(O/N)}^{*3}$	$V_{GS} = 4.5V, I_S = 2.5A$	5.8	8.3	11.9	m Ω
		$V_{GS} = 3.8V, I_S = 2.5A$	6.0	8.8	12.9	
		$V_{GS} = 3.1V, I_S = 2.5A$	6.2	9.9	15.8	
		$V_{GS} = 2.5V, I_S = 2.5A$	6.5	12.1	22.6	
Dynamic Characteristics						
Total Gate Charge	Q_g	$V_{DS} = 10V, I_D = 2.5A, V_{GS} = 4.5V$	-	28.0	-	nC
Gate-Source Charge	Q_{gs}		-	3.5	-	
Gate-Drain Charge	Q_{gd}		-	13.0	-	
Input Capacitance	C_{iss}	$V_{DS} = 10V, V_{GS} = 0V, f = 1MHz$	-	1924	-	pF
Reverse Transfer Capacitance	C_{rss}		-	524	-	
Output Capacitance	C_{oss}		-	620	-	
Turn-On Delay Time	$t_{d(on)}$	$V_{GS} = 4.5V, V_{DS} = 10V, I_D = 5A, R_{GEN} = 3\Omega$	-	85	-	ns
Rise Time	t_r		-	280	-	
Turn-Off Delay Time	$t_{d(off)}$		-	2600	-	
Fall Time	t_f		-	5850	-	
Drain-Source Body Diode Characteristics						
Source-Source Diode Forward Voltage	$V_{F(S-S)}$	$I_S = 1.0A, V_{GS} = 0V$	0.40	0.65	1.0	V

Note *1. Mounted on FR4 board "jesd51-7" (76.2mm x 114.3mm x t1.6mm),

*2. $t_r = 10\mu s$, Duty Cycle $\leq 1\%$

*3. $R_{SS(O/N)}$ is guaranteed by design, not subject to production testing.

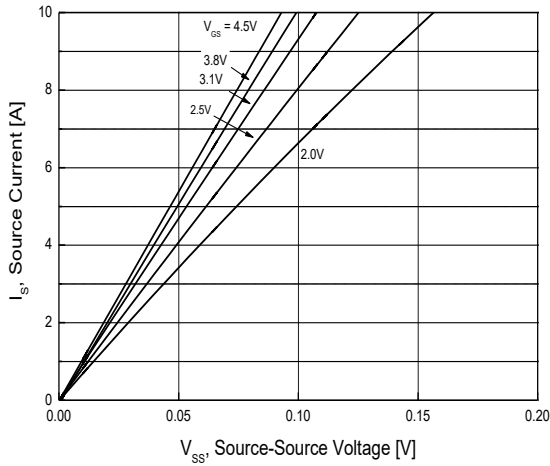

Fig.1 On-Region Characteristics

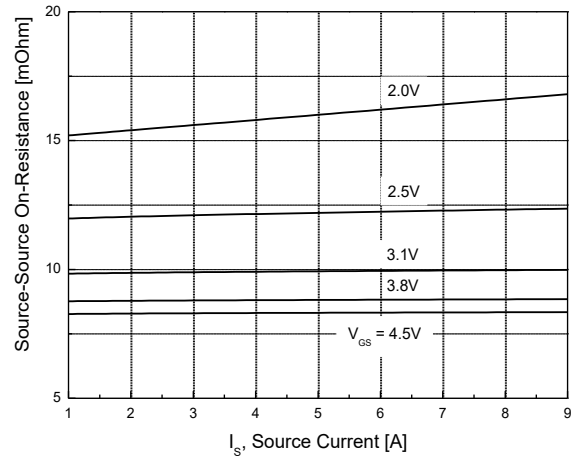

Fig.2 On-Resistance Variation with Drain Current and Gate Voltage

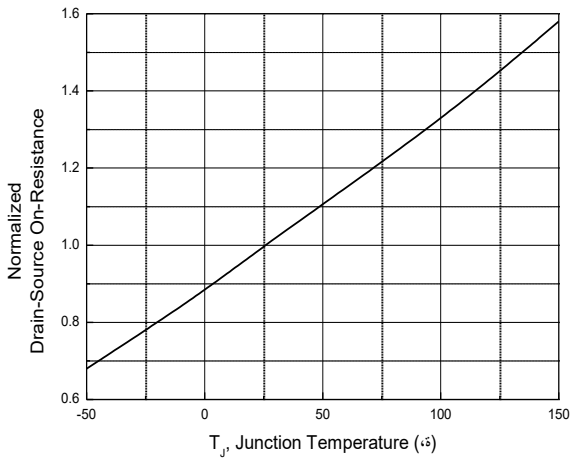

Fig.3 On-Resistance Variation with Temperature

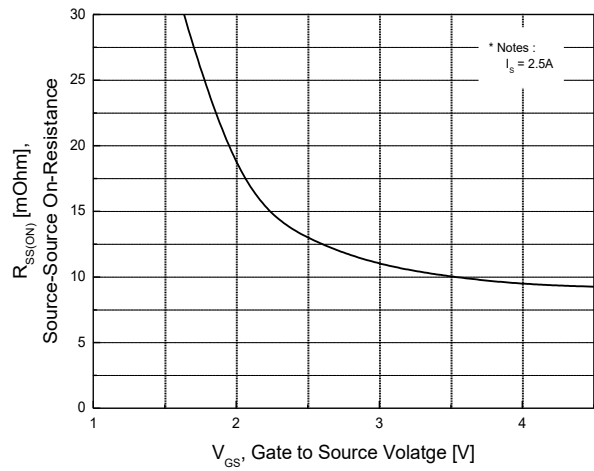

Fig.4 On-Resistance Variation with Gate to Source Voltage

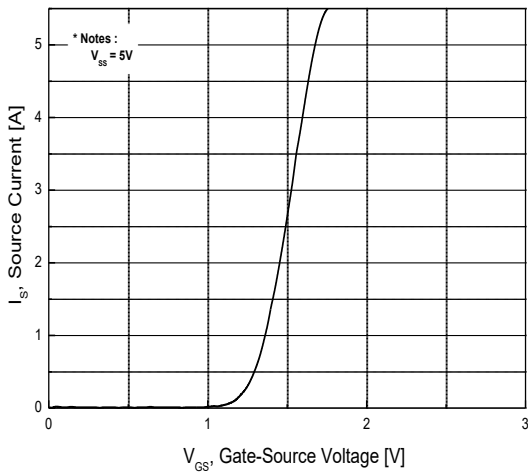

Fig.5 Transfer Characteristics

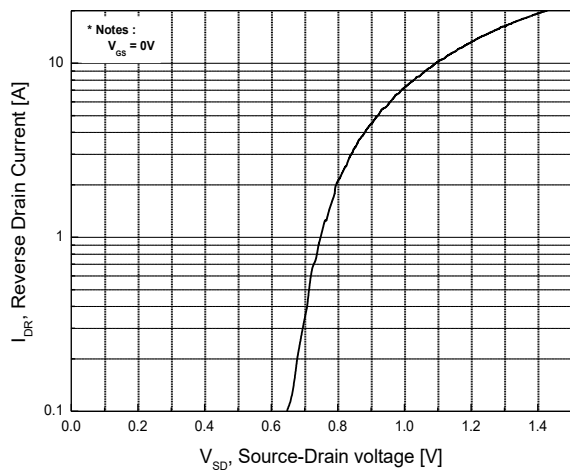

Fig.6 Body Diode Forward Voltage Variation with Source Current and Temperature

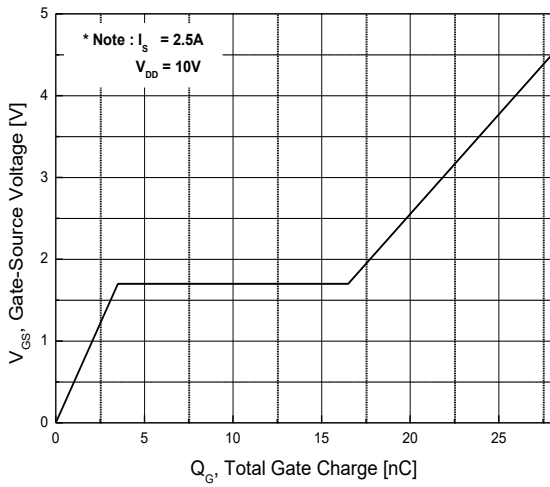

Fig.7 Gate Charge Characteristics

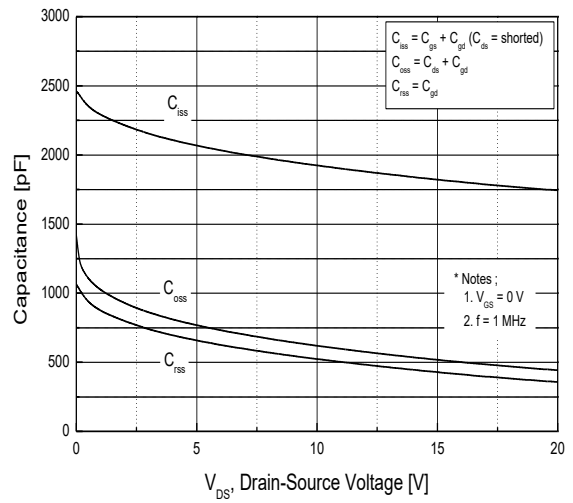

Fig.8 Capacitance Characteristics

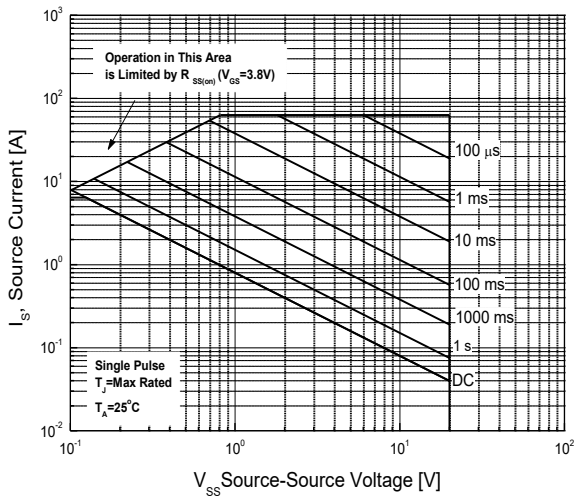

Fig.9 Maximum Safe Operating Area

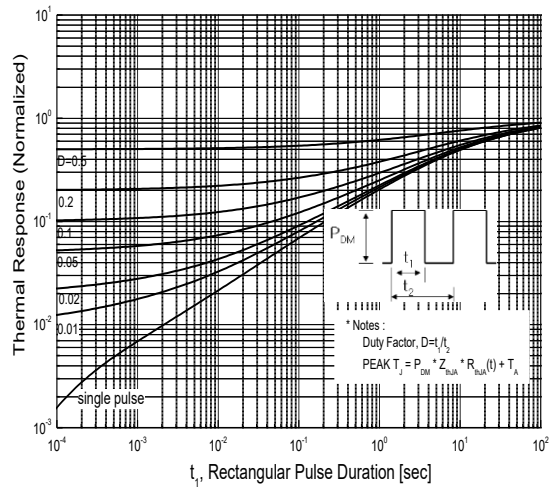
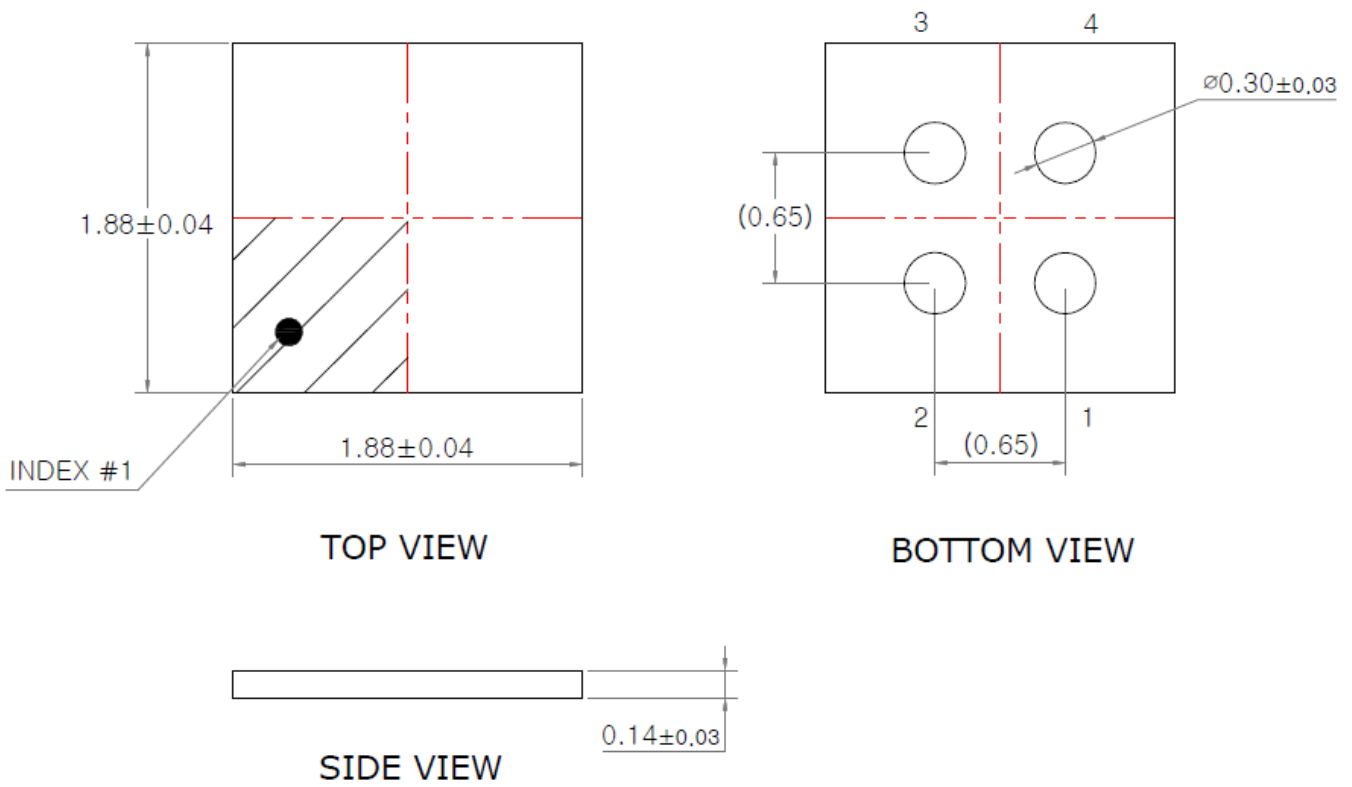

Fig.10 Transient Thermal Response Curve

Package Dimension

WLCSP POD(Package Outline Dimension)

Unit: mm



Note

- * PKG BODY SIZES EXCLUDE FLASH & BURRS
- * THE DIRECTION OF VIEW

DISCLAIMER:

The Products are not designed for use in hostile environments, including, without limitation, aircraft, nuclear power generation, medical appliances, and devices or systems in which malfunction of any Product can reasonably be expected to result in a personal injury. Seller's customers using or selling Seller's products for use in such applications do so at their own risk and agree to fully defend and indemnify Seller.

Magnachip reserves the right to change the specifications and circuitry without notice at any time. Magnachip does not consider responsibility for use of any circuitry other than circuitry entirely included in a Magnachip product.  Magnachip is a registered trademark of Magnachip Semiconductor Ltd.

单击下面可查看定价，库存，交付和生命周期等信息

[>>MAGNACHIP\(美格纳\)](#)