



AMDUA040N070RH

Single N-channel Trench MOSFET 40V 7.0mΩ 35A

FEATURES

- Trench power MOSFET technology
- N-channel, normal level
- 100% Avalanche tested
- Maximum 175°C junction temperature
- AEC-Q101 qualified

APPLICATIONS

- Motor inverter
- Switching applications

KEY PERFORMANCE PARAMETERS

V_{DS}	40	V
$R_{DS(on), typ.}$	0.0061	Ω
I_D	35	A
Q_G	24	nC
Junction temperature, $_{max}$	175	$^{\circ}C$



Top View

PDFN56-DUAL



Bottom View

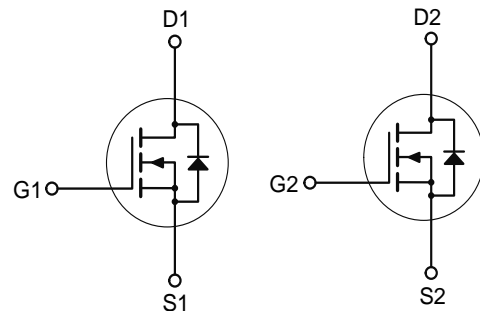

ORDERING INFORMATION

Type / Ordering Code	Package	Marking	Packing	RoHS Status
AMDUA040N070RH	PDFN56-DUAL	040N070	Tape & Reel	Halogen Free

<http://www.magnachip.com/>

ABSOLUTE MAXIMUM RATINGS, at $T_C = 25^\circ\text{C}$, unless otherwise specified

PARAMETER		SYMBOL	RATING	UNIT
Drain-source Voltage		V_{DS}	40	V
Gate-source Voltage		V_{GS}	± 20	V
Drain current	$T_C=25^\circ\text{C}$ (Silicon Limited)	I_D	70	A
	$T_C=25^\circ\text{C}$ (Package Limited)		35	A
	$T_C=100^\circ\text{C}$ (Silicon Limited)		49	A
	$T_C=100^\circ\text{C}$ (Package Limited)		35	A
¹⁾ Pulsed drain current	$T_C=25^\circ\text{C}$	I_{DM}	140	A
Total power dissipation	$T_C=25^\circ\text{C}$	P_{tot}	60	W
	$T_C=100^\circ\text{C}$		30	W
²⁾ Avalanche energy, single pulse		E_{AS}	45	mJ
Operating and storage temperature		T_j, T_{stg}	- 55 ~ 175	$^\circ\text{C}$

THERMAL CHARACTERISTICS

PARAMETER		SYMBOL	RATING	UNIT
Thermal resistance, junction - case		$R_{\theta JC}$	2.5	$^\circ\text{C}/\text{W}$
³⁾ Thermal resistance, junction - ambient		$R_{\theta JA}$	100	$^\circ\text{C}/\text{W}$

ELECTRICAL CHARACTERISTICS (T_J = 25°C)**STATIC CHARACTERISTICS**

PARAMETER	Symbol	Min.	Typ.	Max.	Unit	Conditions / Note
Drain-source breakdown voltage	V _{(BR)DSS}	40	-	-	V	V _{GS} =0 V, I _D =250 μA
Gate threshold voltage	V _{GS(th)}	2.45	3.20	3.95	V	V _{DS} =V _{GS} , I _D =250 μA
Zero gate voltage drain current	I _{DSS}	-	-	1	μA	V _{DS} =40 V, V _{GS} =0 V
Gate-source leakage current	I _{GSS}	-	-	± 100	nA	V _{GS} =±20 V, V _{DS} =0 V
Drain-source on-state resistance	R _{DS(on)}	-	6.1	7.0	mΩ	V _{GS} =10 V, I _D =17.5 A
⁴⁾ Gate resistance	R _G	-	2.3	-	Ω	f=1MHz
⁴⁾ Transconductance	g _{fs}	-	42	-	S	V _{DS} =10 V, I _D =17.5 A

⁴⁾ DYNAMIC CHARACTERISTICS

PARAMETER	Symbol	Min.	Typ.	Max.	Unit	Conditions / Note
Input capacitance	C _{iss}	-	1658	-	pF	V _{GS} =0 V, V _{DS} =20 V, f=1 MHz
Output capacitance	C _{oss}	-	445	-	pF	V _{GS} =0 V, V _{DS} =20 V, f=1 MHz
Reverse transfer capacitance	C _{rss}	-	41	-	pF	V _{GS} =0 V, V _{DS} =20 V, f=1 MHz
Turn-on delay time	t _{d(on)}	-	17	-	ns	V _{DD} =20 V, V _{GS} =10 V, I _D =17.5 A, R _{G,ext} =3Ω
Rise time	t _r	-	11	-	ns	V _{DD} =20 V, V _{GS} =10 V, I _D =17.5 A, R _{G,ext} =3Ω
Turn-off delay time	t _{d(off)}	-	27	-	ns	V _{DD} =20 V, V _{GS} =10 V, I _D =17.5 A, R _{G,ext} =3Ω
Fall time	t _f	-	9	-	ns	V _{DD} =20 V, V _{GS} =10 V, I _D =17.5 A, R _{G,ext} =3Ω

⁴⁾ GATE CHARGE CHARACTERISTICS

PARAMETER	Symbol	Min.	Typ.	Max.	Unit	Conditions / Note
Gate to source charge	Q _{gs}	-	9	-	nC	V _{DD} =20 V, I _D =17.5 A, V _{GS} =0 to 10 V
Gate charge at threshold	Q _{gs(th)}	-	5	-	nC	V _{DD} =20 V, I _D =17.5 A, V _{GS} =0 to 10 V
Gate to drain charge	Q _{gd}	-	3	-	nC	V _{DD} =20 V, I _D =17.5 A, V _{GS} =0 to 10 V
Switching charge	Q _{sw}	-	7	-	nC	V _{DD} =20 V, I _D =17.5 A, V _{GS} =0 to 10 V
Gate charge total	Q _g	-	24	-	nC	V _{DD} =20 V, I _D =17.5 A, V _{GS} =0 to 10 V
Gate plateau voltage	V _{plateau}	-	5.1	-	V	V _{DD} =20 V, I _D =17.5 A, V _{GS} =0 to 10 V

SOURCE-DRAIN DIODE

PARAMETER	Symbol	Min.	Typ.	Max.	Unit	Conditions / Note
⁴⁾ Diode continuous forward current	I _S	-	-	35	A	-
⁴⁾ Diode pulse current	I _{S,pulse}	-	-	140	A	pulsed; t _p ≤ 10 μs
Diode forward voltage	V _{SD}	-	0.9	1.2	V	V _{GS} =0 V, I _F =17.5 A
⁴⁾ Reverse recovery time	t _{rr}	-	57.1	-	ns	I _F =17.5 A, d _{I_F}/dt=100 A/μs}
⁴⁾ Reverse recovery charge	Q _{rr}	-	51.7	-	nC	I _F =17.5 A, d _{I_F}/dt=100 A/μs}

Notes

- Pulse width limited by T_{Jmax}
- Starting T_J=25°C, L=1mH, I_{AS}=9.5A, V_{DD}=36V, V_{GS}=10V
- Surface mounted FR-4 board by JEDEC (jesd51-7)
- The parameter is not subject to production testing - guaranteed by design.

ELECTRICAL CHARACTERISTICS DIAGRAMS (25 °C, unless otherwise noted)

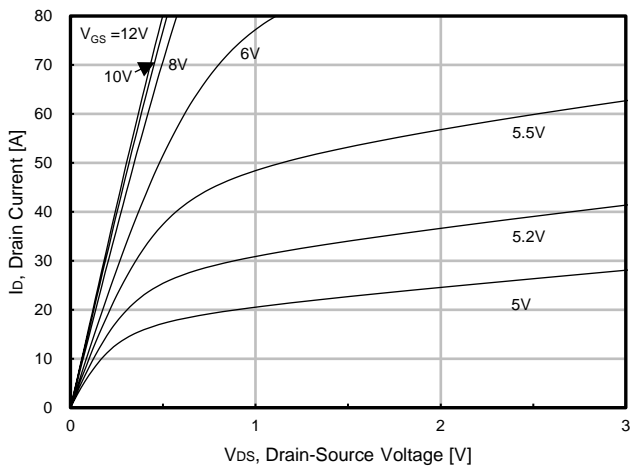

Fig. 1. Output Characteristics (25°C)

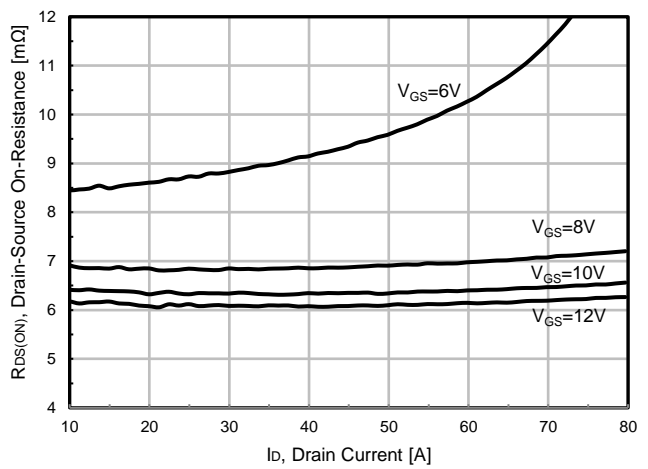

Fig. 2. Static On-Resistance Variation

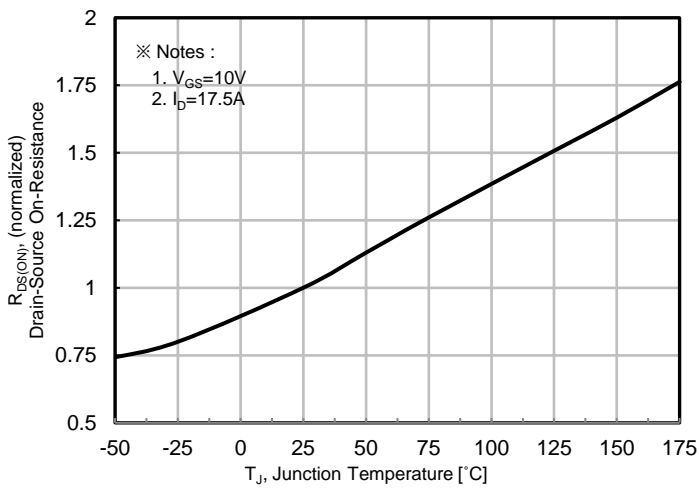

Fig. 3. On-Resistance vs. Junction Temperature

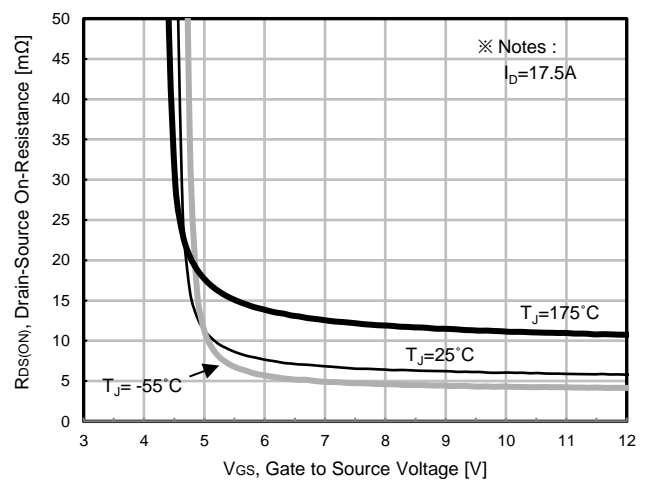

Fig. 4. On-Resistance vs. Gate to source Voltage

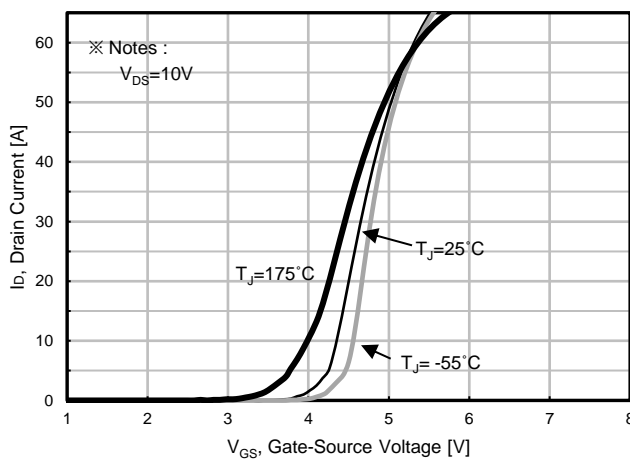

Fig. 5. Transfer Characteristics

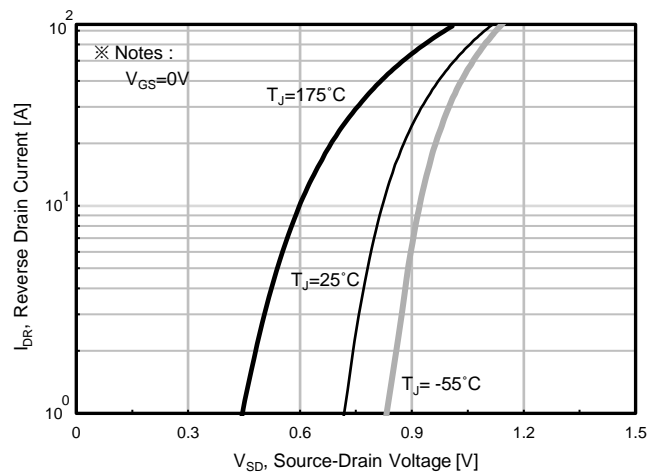

Fig. 6. Body Diode Forward Voltage Variation with Source Current and Temperature

ELECTRICAL CHARACTERISTICS DIAGRAMS (25 °C, unless otherwise noted)

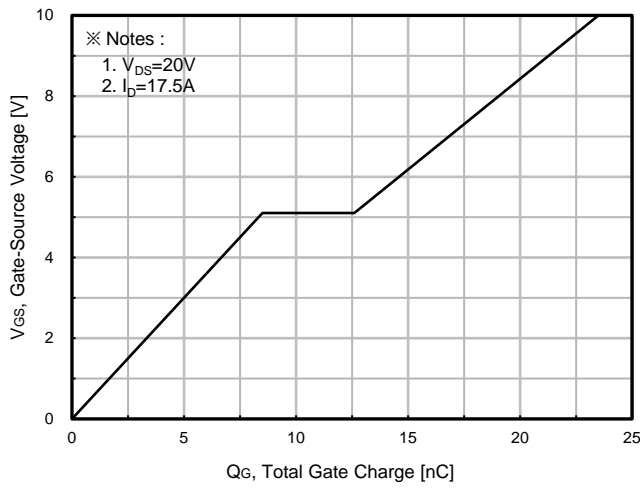

Fig. 7. Gate Charge

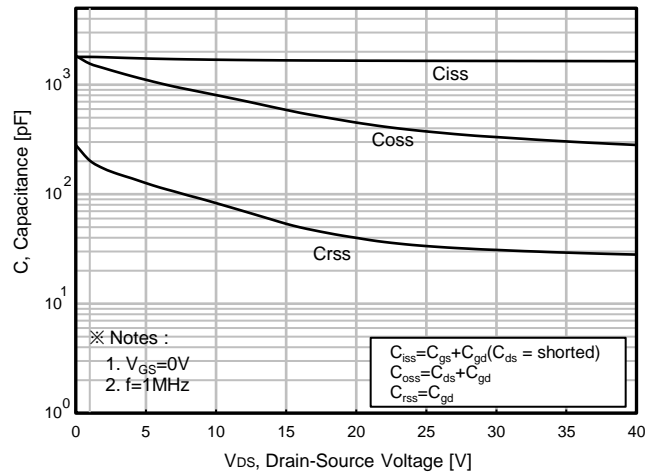

Fig. 8. Capacitance

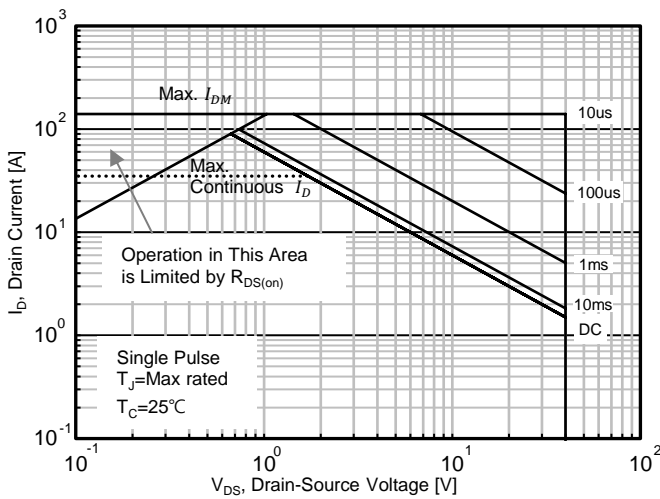

Fig. 9. Safe Operating Area, Junction-to-Ambient

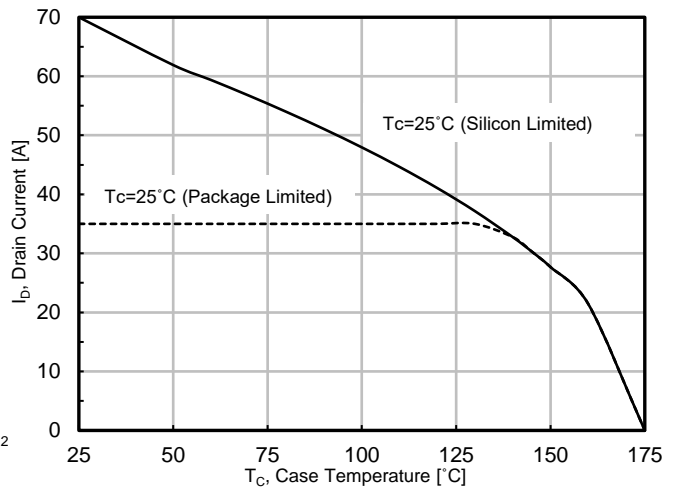

Fig. 10. Maximum Drain vs. Case Temperature

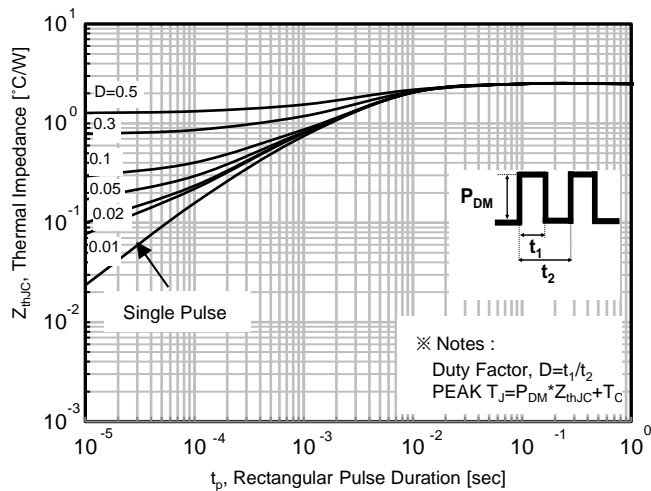
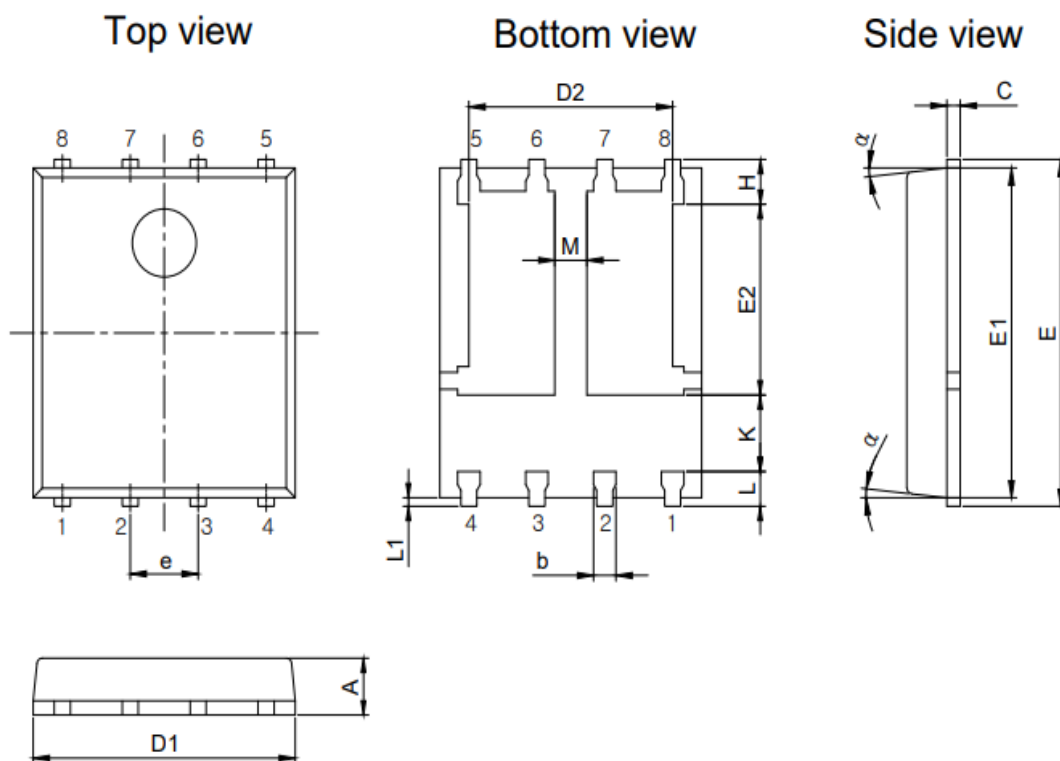

Fig. 11. Transient Thermal Impedance Junction to Case (Rthjc)

Package information

PDFN56-DUAL



Symbol	Dimension (mm)		
	Min	Nom	Max
A	0.90	1.00	1.10
b	0.33	0.41	0.51
C	0.20	0.25	0.30
D1	4.80	4.90	5.00
D2	3.61	3.81	3.96
E	5.90	6.00	6.10
E1	5.70	5.75	5.80
E2	3.38	3.58	3.78
e	1.27 BSC		
H	0.41	0.51	0.61
K	1.10	-	-
L	0.51	0.61	0.71
L1	0.06	0.13	0.20
M	0.50	-	-
α	0°	-	12°

Notes

Package body size, length and width do not include mold flash, protrusions and gate burrs.

DISCLAIMER :

The Products are not designed for use in hostile environments, including, without limitation, aircraft, nuclear power generation, medical appliances, and devices or systems in which malfunction of any Product can reasonably be expected to result in a personal injury. Seller's customers using or selling Seller's products for use in such applications do so at their own risk and agree to fully defend and indemnify Seller.

Magnachip reserves the right to change the specifications and circuitry without notice at any time. Magnachip does not consider responsibility for use of any circuitry other than circuitry entirely included in a Magnachip product.  Magnachip are registered trademarks of Magnachip Semiconductor Ltd.

单击下面可查看定价，库存，交付和生命周期等信息

[>>MAGNACHIP\(美格纳\)](#)