

Uni-polar, High Voltage Hall-Effect Switch IC

1 Product Description

The MT831X family is produced by BCD technology with both high performance and high reliability. The Hall IC internally includes an on-chip Hall voltage generator, a voltage regulator for operation with supply voltage of 3.8V to 60V, temperature compensation circuitry, small-signal amplifier, Hall IC with dynamic offset cancellation system, Schmitt trigger and an open collector output. It also includes a clamp diode at output and reversed power supply protection enhances the robustness of Hall IC.

The Hall IC designed to respond to a single poles. While the magnetic flux density(B) is larger than operating point (BOP), the output will be turned on (Low), the output is held until the magnetic flux density(B) is lower than releasing point (BRP), then turn off (High).

The MT831X family provides a variety of packages to customers: SOT-23/SOT-23 (Thin Outline)/SOT-89B for surface mount and flat TO-92 for through-hole mount. All packages are RoHS compliant.

2 Feature

- BCD Technology
- Uni-polar Switch
- 3.8~60V Operating Vcc Range
- -40°C~150°C Operating Temperature
- Package Option:
 - Flat TO-92
 - SOT-23
 - SOT-23 (Thin Outline)
 - SOT-89B
- Magnetic Sensitivity Option:
 - MT8311 (BOP=140Gs, BRP=105Gs)
 - MT8312 (BOP=255Gs, BRP=210Gs)
 - MT8313 (BOP=85Gs, BRP=50Gs)
- Open-Drain Output
- -24V Reversed Power Supply Protection
- Output Limiting Current Protection
- RoHS Compliant: 2011/65/EU

3 Product Overview of MT831X

Part No.	Description
MT831XA	Flat TO-92, bulk packaging (1000pcs/bag)
MT831XAT	SOT-23, tape & reel (3000pcs/bag)
MT831XET	SOT-23 (Thin Outline), tape & reel (3000pcs/bag)
MT831XBT	SOT-89B, tape & reel (1000pcs/bag)

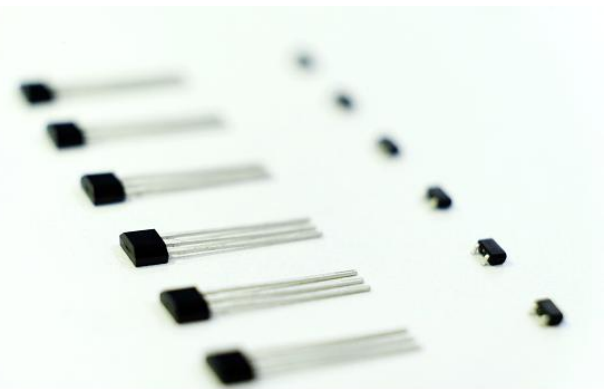

4 Application

- Automotive, Home appliances, Industrial
- Speed Detection
- Position Detection
- Magnetic Encoder
- Solid-State Switch
- Proximity Switch

5. Pin Configuration and Functions

	Vcc	Out	GND
SOT-23	1	2	3
SOT-23 (Thin Outline)	1	2	3
Flat TO-92	1	3	2
SOT-89B	1	3	2
Description	Power	Output Open-Drain	Ground

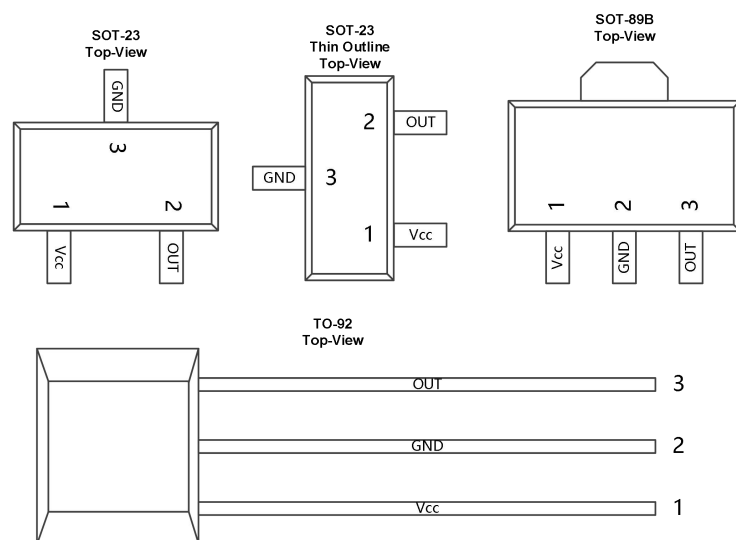

Figure.1 Pin Configuration & Functions

Table of Contents

1	Product Description.....	1
2	Feature.....	1
3	Product Overview of MT831X	1
4	Applications.....	1
5	Pin Configuration and Functions.....	1
6	Definition of Switching Function.....	3
7	Function Description.....	3
8	Feature Description.....	3
9	Functional Block Diagram.....	4
10	Electrical and Magnetic Characteristics.....	4
	10.1 Absolute Maximum Ratings.....	4
	10.2 Electrical Specifications.....	5
	10.3 Magnetic Characteristics.....	5
	10.4 ESD Ratings.....	5
	10.5 Characteristic Performance.....	6
	10.6 Typical Output Waveform.....	7
11	Typical Application Circuit.....	7
12	Package Material Information.....	8
	12.1 SOT-23 Package Information.....	8
	12.2 SOT-23 (Thin Outline) Package Information.....	9
	12.3 Flat TO-92 Package Information.....	10
	12.4 SOT-89B Package Information.....	11

Reversion History

1	Originally Version	2018 Sep	
2	1.1 Version	2018 Dec	Update MT8312 & MT8313 Series Update SOT-23 (Thin Outline) Package

6 Definition of Switching Function

Figure.2 & Figure.3 shows the device functionality and hysteresis

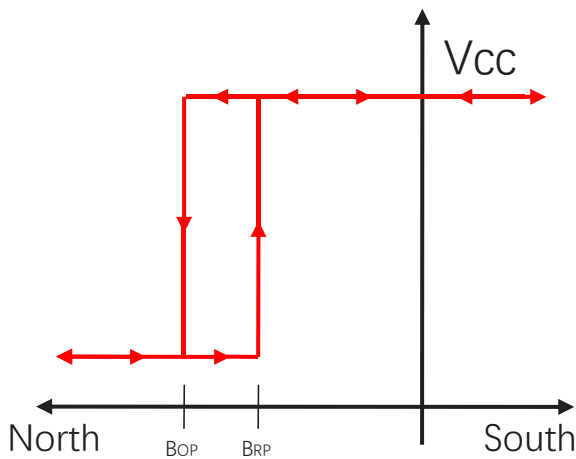

Figure.2 Switching Function Uni-polar (North)
SOT-23

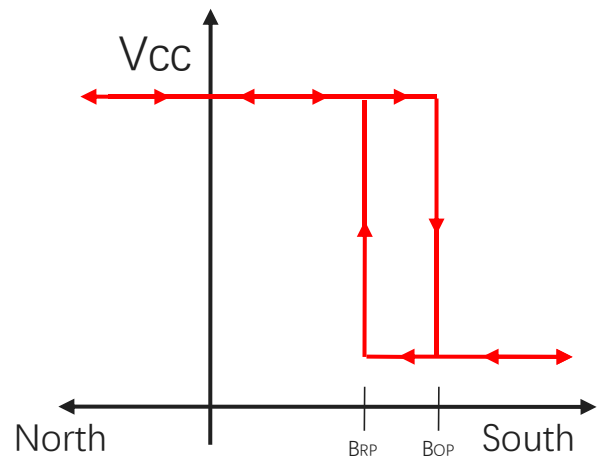

Figure.3 Switching Function Uni-polar (South)
SOT-23 (Thin Outline) / Flat TO-92 / SOT-89B

7 Function Description

B_{OP}: Operating Point, Magnetic flux density applied on the branded side of the package which turns the output driver ON ($V_{OUT}=Low$)

B_{RP}: Releasing Point, Magnetic flux density applied on the branded side of the package which turns the output driver OFF ($V_{OUT}=High$)

B_{HYST}: Hysteresis Window, $|B_{OP} - B_{RP}|$

Devices that have a lower magnetic threshold ($V_{OUT}=High$) detect magnets at a farther distance. Higher thresholds ($V_{OUT}=Low$) generally require a closer distance or larger magnet.

8 Feature Description

The MT831X device is sensitive to the magnetic field component that is perpendicular to the top of the package

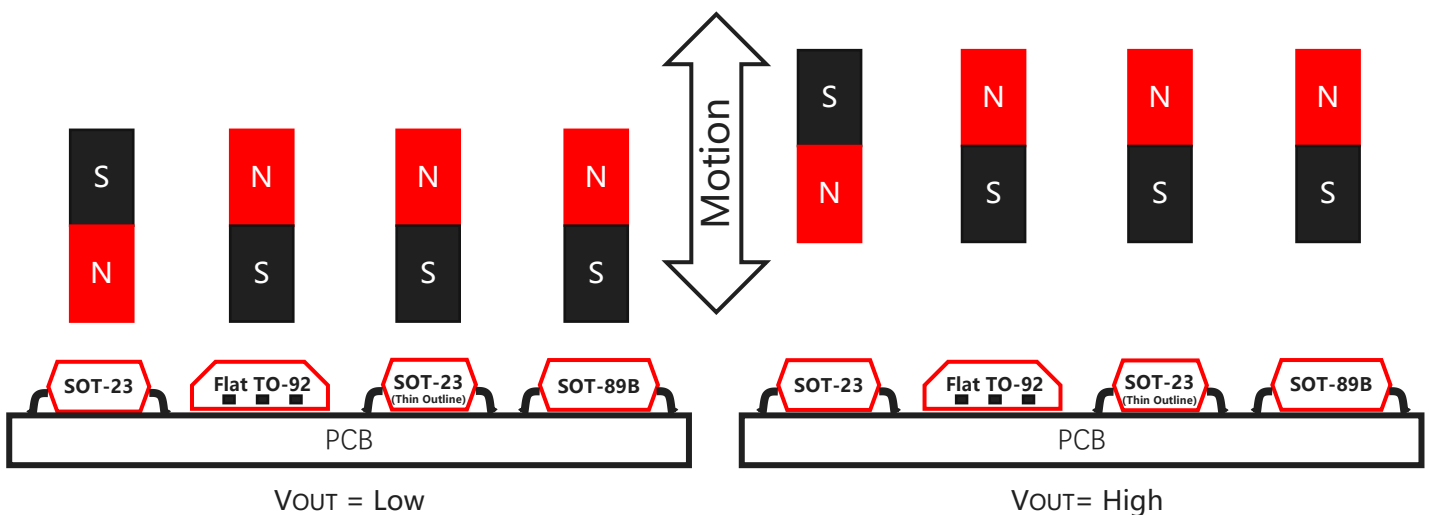

Figure.4 Flux Direction Polarity

9 Functional Block Diagram

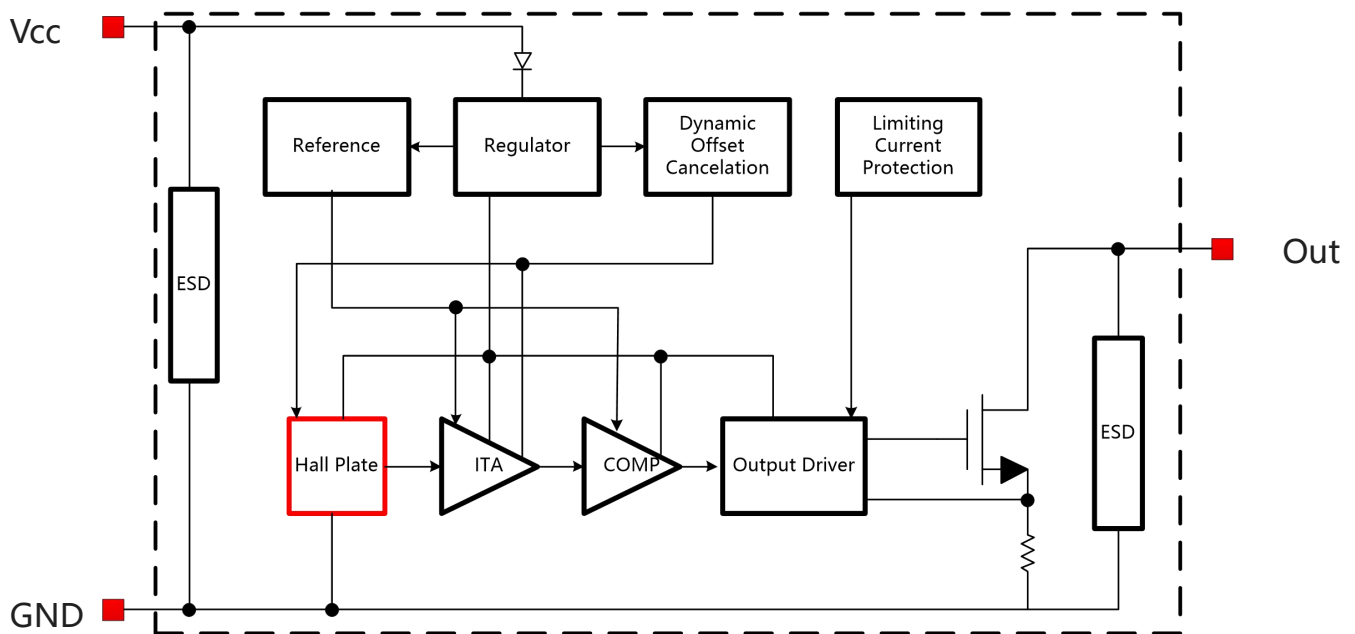

Figure.5 Functional Block Diagram

10 Electrical and Magnetic Characteristics

10.1 Absolute Maximum Ratings

Absolute maximum ratings are limited values to be applied individually, and beyond which the serviceability of the circuit may be impaired. Functional operability is not necessarily implied. Exposure to absolute maximum rating conditions for an extended period of time may affect device reliability.

Symbol	Parameters	Min	Max	Units
V _{CC}	Supply Voltage	-	65	V
V _{RCC}	Reverse Battery Voltage	-24	-	V
V _{OUT}	Output Voltage	-	65	V
I _{OUT}	Continuous Output Current	-	50	mA
T _A	Operating Ambient Temperature	-40	150	°C
T _S	Storage Temperature	-50	150	°C
T _J	Junction Temperature	-	165	°C
B	Magnetic Flux Density	No Limit		Gs

10.2 Electrical Specifications

At $T_A = -40 \sim 150$ °C, $V_{CC} = 3.8V \sim 60V$ (unless otherwise specified)

Symbol	Parameters	Test Condition	Min	Typ	Max	Unit
V _{CC}	Supply Voltage	Operating	3.8	-	60	V
I _{CC}	Supply Current	B < B _{RP}	-	4	6	mA
I _{OCP}	Short Circuit Protection Current	B > B _{OP} , V _{OUT} = V _{CC}	-	50	-	mA
V _{DSON}	Output Saturation Voltage	I _{OUT} = 20mA, B > B _{OP}	-	-	0.4	V
I _{OFF}	Output Leakage Current	V _{OUT} = 24V, B < B _{RP}	-	-	10	uA
T _R	Output Rise Time	R _L = 1KOhm, C _L = 20pF	-	-	1.0	us
T _F	Output Fall Time	R _L = 1KOhm, C _L = 20pF	-	-	1.0	us
T _{PO}	Power on Time	dV _{CC} /dt > 5V/uS B > B _{OP(MAX)}	-	-	10	us
F _C	Chopping Frequency		-	800	-	KHz
F _S	Sampling Frequency		-	200	-	KHz
R _{TH}	Thermal Resistance of SOT-23		-	301	-	°C/W
	Thermal Resistance of SOT-23 (Thin Outline)		-	301	-	°C/W
	Thermal Resistance of TO-92		-	230	-	°C/W
	Thermal Resistance of SOT-89B		-	230	-	°C/W

10.3 Magnetic Characteristics

At $V_{CC} = 3.8V \sim 60V$ (unless otherwise specified)

Part No.	Symbol	Min	Typ	Max	Unit
MT8311 Series	B _{OP} , T _A = 25°C	110	140	170	Gs
	B _{RP} , T _A = 25°C	75	105	135	Gs
	B _{HYST} , T _A = 25°C	20	35	50	Gs
MT8312 Series	B _{OP} , T _A = 25°C	210	255	300	Gs
	B _{RP} , T _A = 25°C	165	210	255	Gs
	B _{HYST} , T _A = 25°C	30	45	60	Gs
MT8313 Series	B _{OP} , T _A = 25°C	60	85	110	Gs
	B _{RP} , T _A = 25°C	25	50	75	Gs
	B _{HYST} , T _A = 25°C	15	30	45	Gs

10.4 ESD Ratings

Symbol	Reference	Values	Unit
V _{ESD}	Human-body model (HBM)	AEC-Q100-002	Class II Grade
	Charged-device model (CDM)	AEC-Q100-011	±1000 V

10.5 Characteristic Performance

At $V_{CC}=5V$

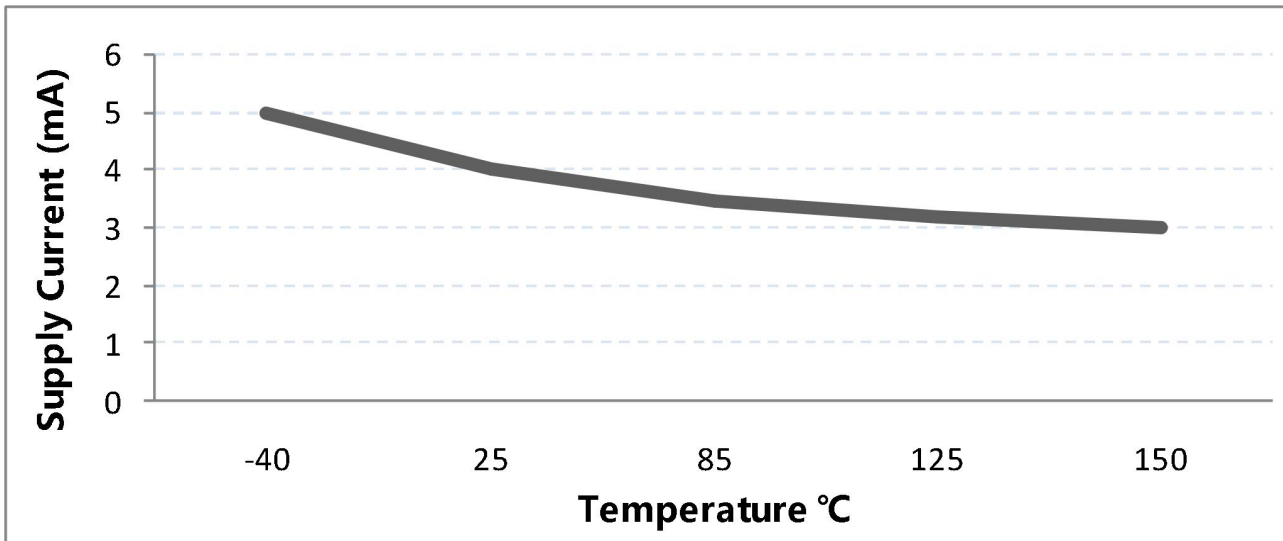

Figure.6 Supply Current vs. Temperature

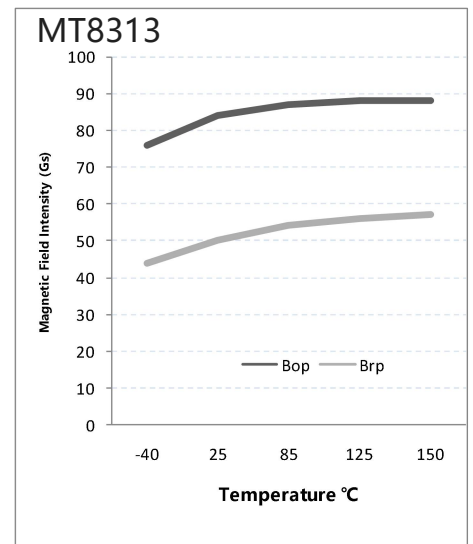
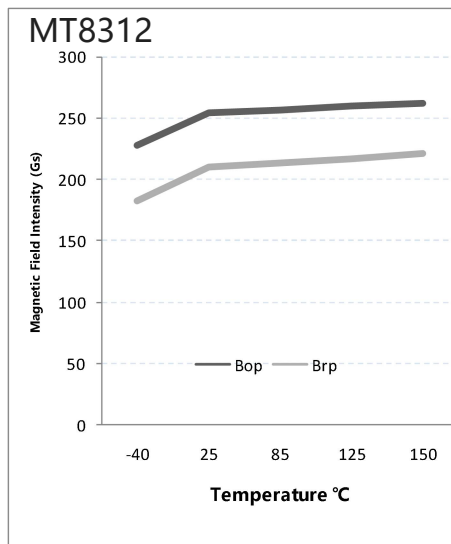
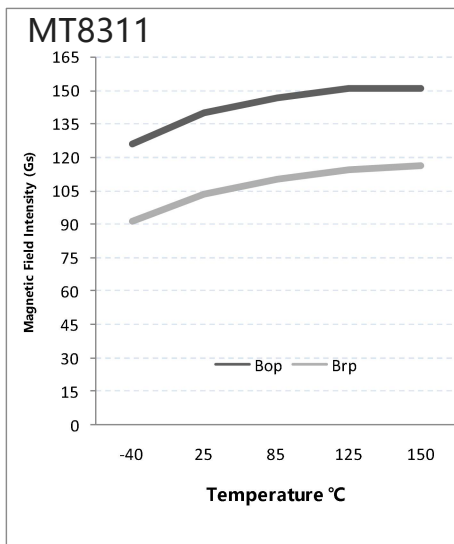

Figure.7 Magnetic Characteristics vs. Temperature (BOP & BRP)

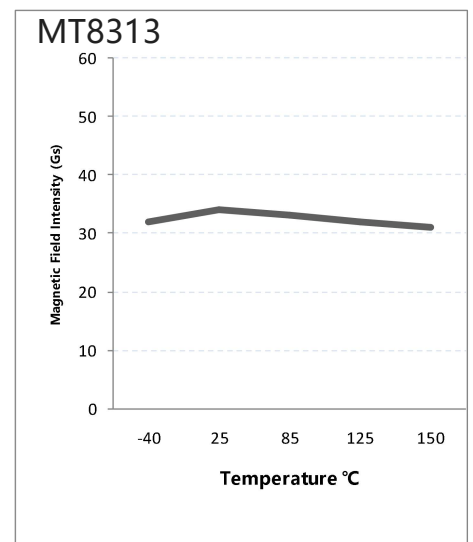
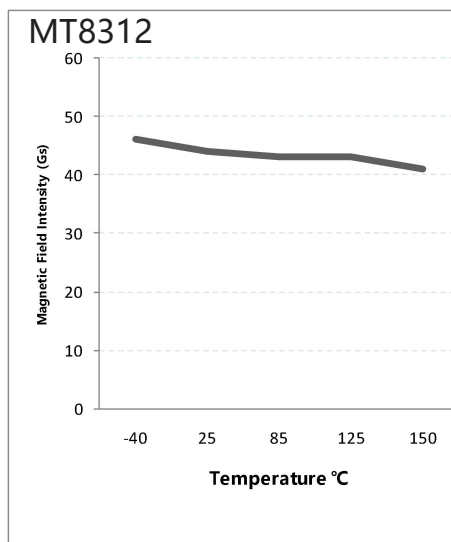
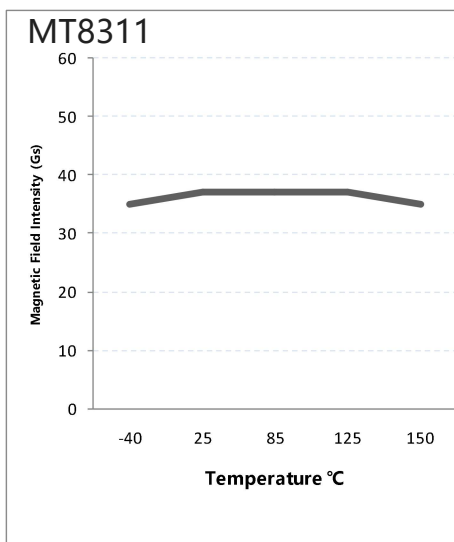

Figure.8 Magnetic Characteristics vs. Temperature (BHYST)

10.6 Typical Output Waveform

MT8311A as example

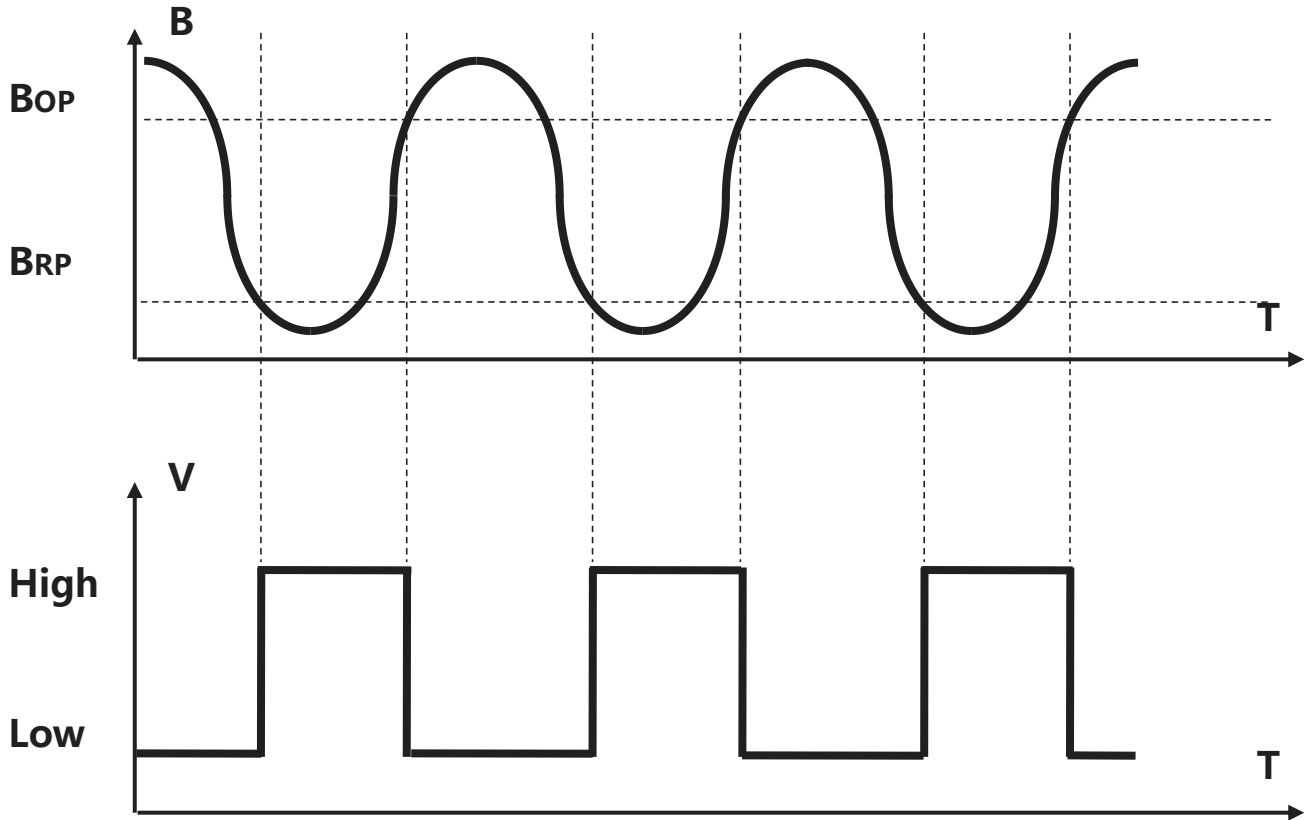

Figure.9 Digital Output vs. Magnetic Flux Density

11 Typical Application Circuit

MT8311AT as example

Note: Recommended value for R_L is 1KOhms to 10KOhms

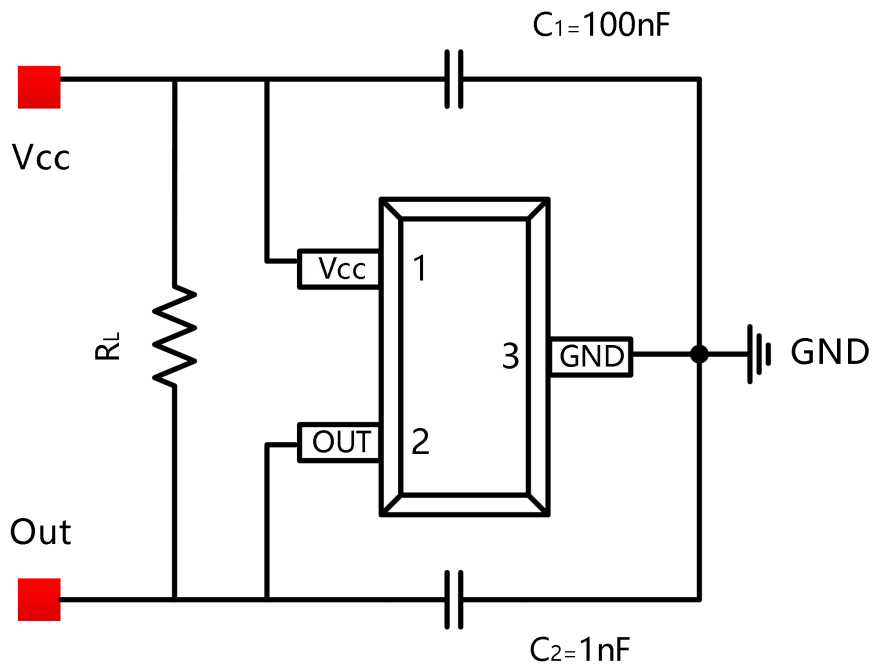

Figure.10 Typical Application Circuit

12 Package Material Information (For Reference Only – Not for Tooling Use)

12.1 SOT-23 Package Information

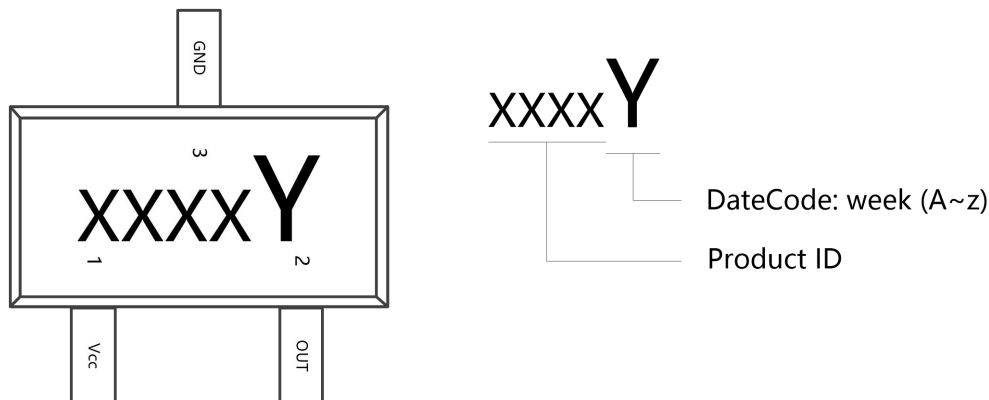

Figure.11 SOT-23 Chip Marking Spec

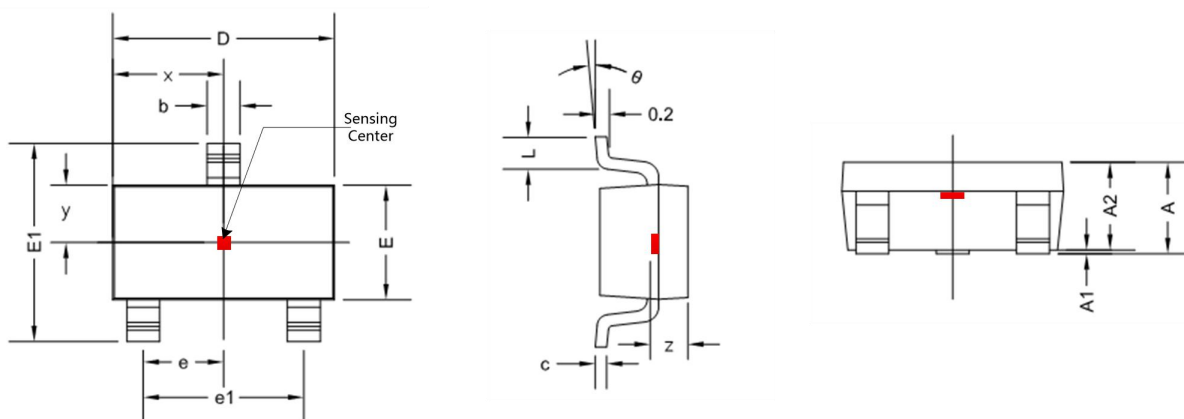

Figure.12 SOT-23 Package Drawing

Symbol	Dimensions in Millimeters		Dimensions in Inches	
	Min	Max	Min	Max
A	1.050	1.250	0.041	0.049
A1	0.000	0.100	0.000	0.004
A2	1.050	1.150	0.041	0.045
b	0.300	0.500	0.012	0.020
c	0.100	0.200	0.004	0.008
D	2.820	3.020	0.111	0.119
E	1.500	1.700	0.059	0.067
E1	2.650	2.950	0.104	0.116
e	0.950 TYP		0.037 TYP	
e1	1.800	2.000	0.071	0.079
L	0.300	0.600	0.012	0.024
θ	0 °	8 °	0 °	8 °
x	1.460 TYP		0.057 TYP	
y	0.800 TYP		0.032 TYP	
z	0.600 TYP		0.024 TYP	

12.2 SOT-23 (Thin Outline) Package Information

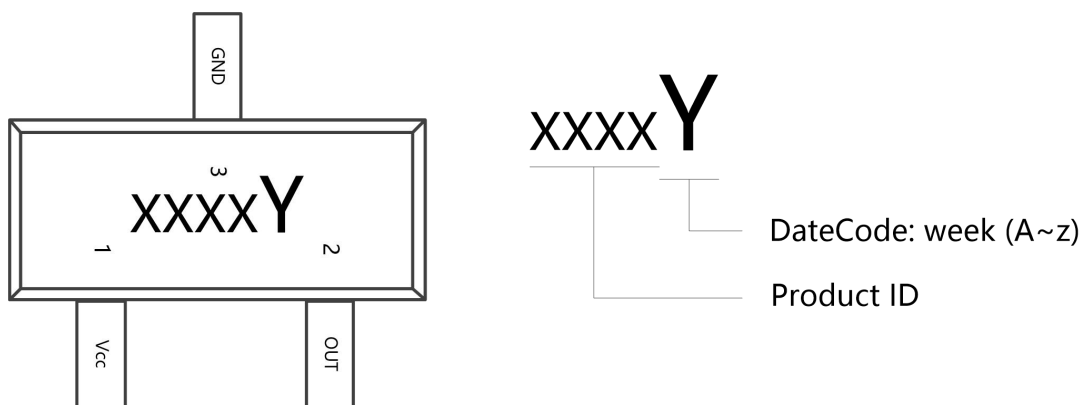

Figure.13 SOT-23 (Thin Outline) Chip Marking Spec

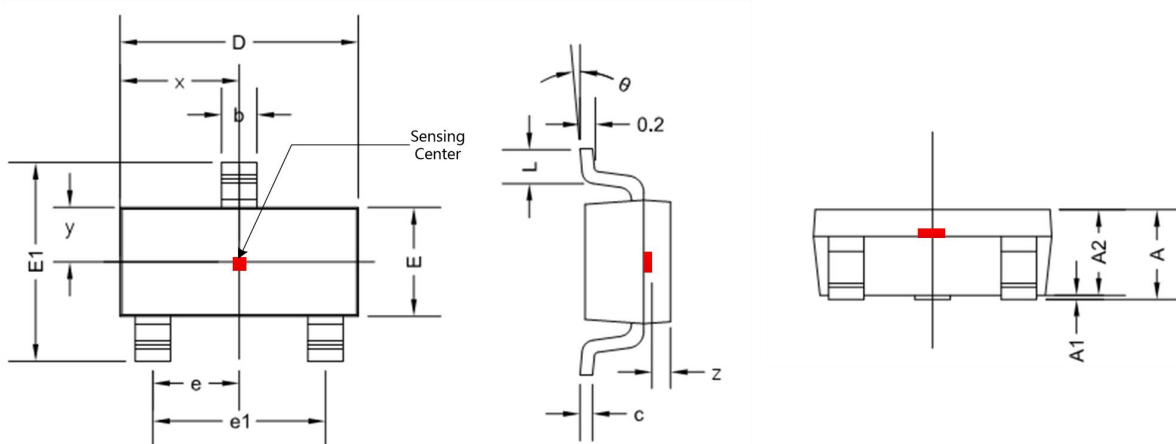

Figure.14 SOT-23 (Thin Outline) Package Drawing

Symbol	Dimensions in Millimeters		Dimensions in Inches	
	Min	Max	Min	Max
A	0.900	1.150	0.035	0.045
A1	0.000	0.100	0.000	0.004
A2	0.900	1.050	0.035	0.041
b	0.300	0.500	0.012	0.020
c	0.080	0.150	0.003	0.006
D	2.800	3.000	0.110	0.118
E	1.200	1.400	0.047	0.055
E1	2.250	2.550	0.089	0.100
e	0.950 TYP		0.037 TYP	
e1	1.800	2.000	0.071	0.079
L	0.550 REF		0.022 REF	
L1	0.300	0.500	0.012	0.020
θ	0 °	8 °	0 °	8 °
x	1.460 TYP		0.057 TYP	
y	0.650 TYP		0.026 TYP	
z	0.500 TYP		0.020 TYP	

12.3 Flat TO-92 Package Information

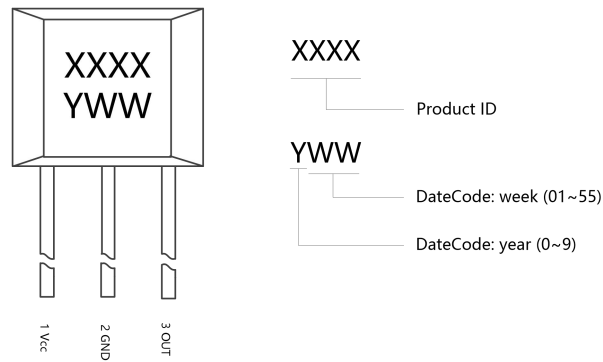

Figure.15 Flat TO-92 Chip Marking Spec

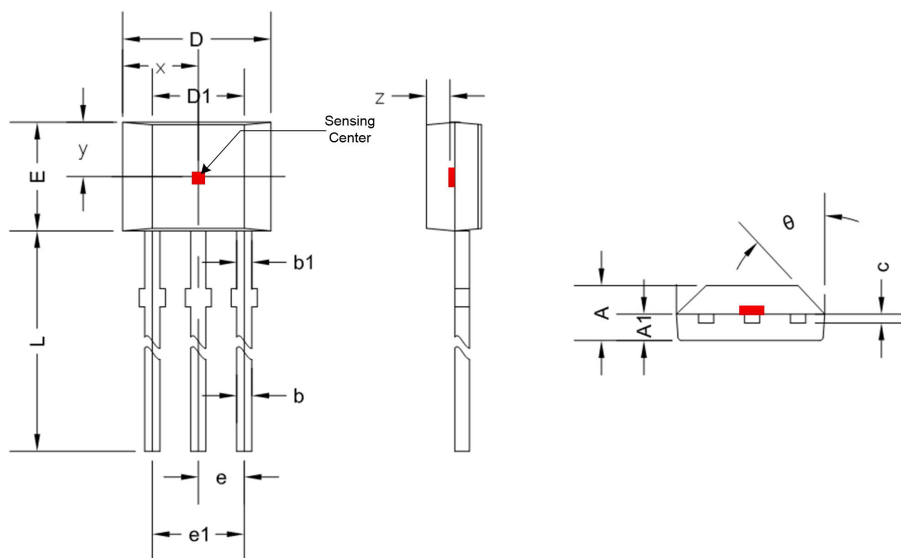

Figure.16 Flat TO-92 Package Drawing

Symbol	Dimensions in Millimeters		Dimensions in Inches	
	Min	Max	Min	Max
A	1.420	1.620	0.056	0.064
A1	0.660	0.860	0.026	0.034
b	0.350	0.480	0.013	0.019
b1	0.400	0.510	0.016	0.020
c	0.330	0.510	0.013	0.020
D	3.900	4.100	0.154	0.161
D1	2.280	2.680	0.090	0.106
E	3.050	3.250	0.120	0.128
e	1.270 TYP		0.050 TYP	
e1	2.440	2.640	0.096	0.104
L	14.350	14.750	0.565	0.581
θ	45 ° TYP		45 ° TYP	
x	2.025 TYP		0.080 TYP	
y	1.545 TYP		0.061 TYP	
z	0.500 TYP		0.020 TYP	

12.4 SOT-89B Package Information

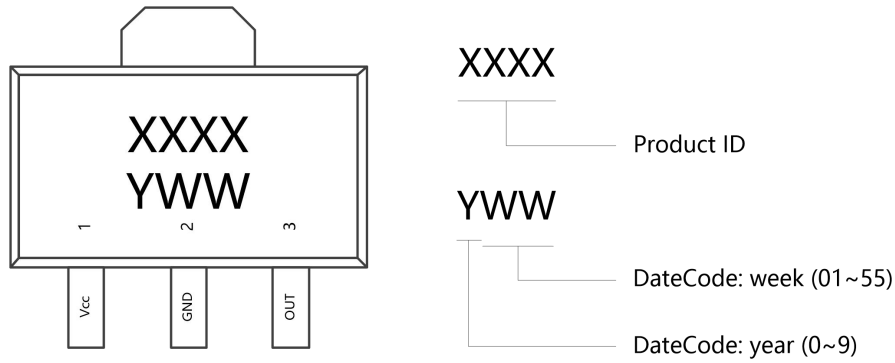

Figure.17 SOT-89B Chip Marking Spec

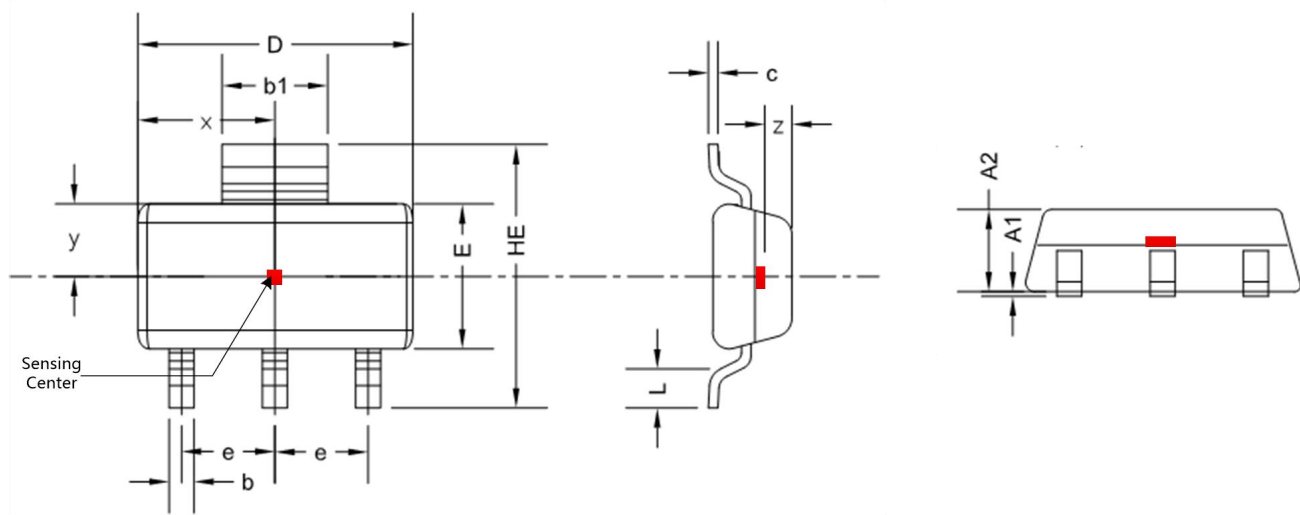

Figure.18 SOT-89B Package Drawing

Symbol	Dimensions in Millimeters		Dimensions in Inches	
	Min	Max	Min	Max
A2	1.220	1.420	0.048	0.056
A1	0.000	0.100	0.000	0.004
b	0.300	0.500	0.012	0.020
c	0.052	0.252	0.002	0.010
D	4.400	4.600	0.173	0.181
b1	1.600	1.800	0.063	0.071
E	2.400	2.600	0.094	0.102
HE	4.000	4.400	0.157	0.173
e	1.400	1.600	0.055	0.063
L	0.350	0.550	0.014	0.022
x	2.250 TYP		0.089 TYP	
y	1.250 TYP		0.049 TYP	
z	0.300 TYP		0.012 TYP	

单击下面可查看定价，库存，交付和生命周期等信息

[>>Magntek\(麦歌恩\)](#)