

## Omni-polar, Low Power, 360 Degree Switch IC

### 1 Product Description

The MT613X family is produced with monolithic technology, which builds AMR sensor & ASIC on one chip. The IC internally includes a Wheatstone bridge with magnetic film, a current regulator for operating with supply voltage from 1.65V to 5.0V, a sleep/awake logic for low power consumption requirement, small signal amplifier and Schmitt trigger comparator with dynamic offset cancellation, and an output driver with push pull output.

When combined with a magnet, it becomes a non-contact switch with low power consumption, high sensitivity and high reliability. All directions of horizontal magnetic field parallel to the electrode of the package can be detected by an arbitrary polarity.

The MT613X family provide SOT-23 for surface mount, RoHS compliant.

### 2 Feature

- Monolithic Technology
- 360 Degree AMR (Anisotropic Magneto Resistance)
- Omni-polar Switch
- 1.65~5.0V Operating Vcc Range
- -40°C~125°C Operating Temperature
- Package Option:  
SOT-23
- Magnetic Sensitivity Option:  
BOP=±18Gs, BRP=±13Gs
- Push Pull & Open Drain Output Option:  
MT6131 & MT6132: Push Pull  
MT6133 & MT6135: Open Drain
- Operation Frequency Option:  
MT6131 & MT6133: 20Hz  
MT6132 & MT6135: 1KHz
- Low Power Consumption
- RoHS Compliant: 2011/65/EU

### 3 Product Overview of MT613X

Part No.	Description
MT613XAT	SOT-23, tape & reel (3000pcs/bag)

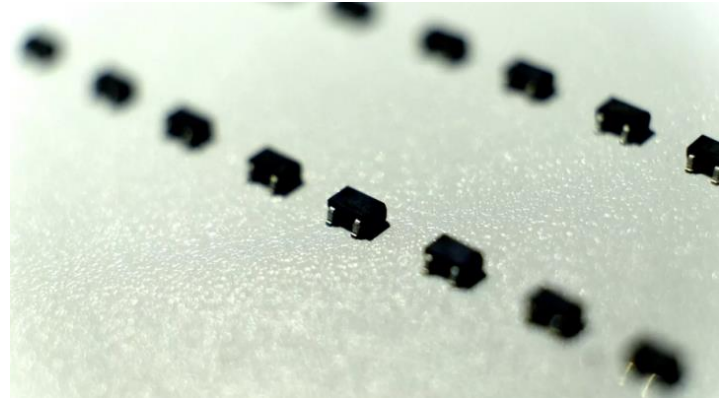

### 4 Application

- Home appliances, Industrial
- Position Detection
- Proximity Switch
- Smart Meter
- Speed Detection
- Handheld Device
- Consumer Device

### 5. Pin Configuration and Functions

	Vcc	Out	GND
SOT-23	1	2	3
Description	Power	Output Push Pull or Open Drain	Ground

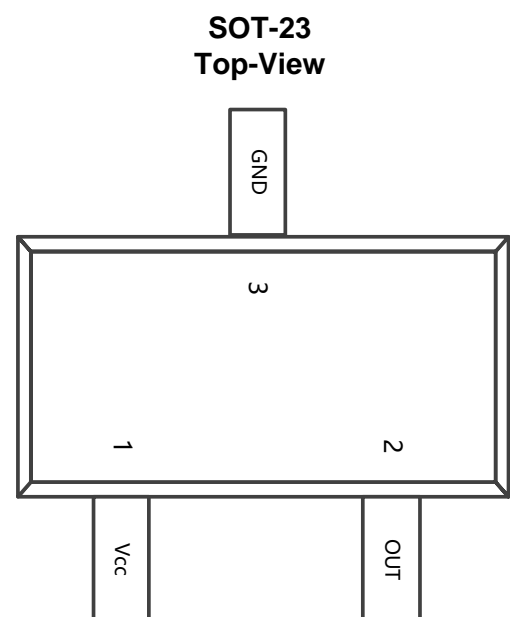

Figure.1 Pin Configuration & Functions

## Table of Contents

1	Product Description.....	1
2	Feature.....	1
3	Product Overview of MT613X .....	1
4	Applications.....	1
5	Pin Configuration and Functions.....	1
6	Definition of Switching Function.....	3
7	Function Description.....	3
8	Feature Description.....	3
9	Functional Block Diagram.....	4
10	Electrical and Magnetic Characteristics.....	5
	10.1 Absolute Maximum Ratings.....	5
	10.2 Electrical Specifications.....	5
	10.3 Magnetic Characteristics.....	6
	10.4 ESD Ratings.....	6
	10.5 Characteristic Performance.....	6
	10.6 Typical Output Waveform.....	7
11	Typical Application Circuit.....	7
12	Power on Output Waveform.....	8
13	Package Material Information.....	9
	13.1 SOT-23 Package Information.....	9

## Reversion History

1	Originally Version	2018 Nov
---	--------------------	----------

### 6 Definition of Switching Function

Figure.2 shows the device functionality and hysteresis

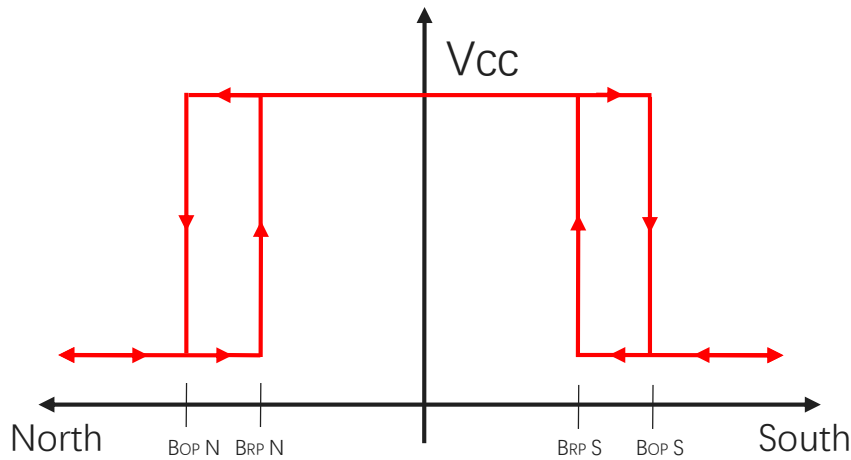

Figure.2 Omni-polar Switching Function

### 7 Function Description

**B<sub>OP</sub>:** Operating Point, Magnetic flux density applied on the branded side of the package which turns the output driver ON ( $V_{OUT}=Low$ )

**B<sub>RP</sub>:** Releasing Point, Magnetic flux density applied on the branded side of the package which turns the output driver OFF ( $V_{OUT}=High$ )

**B<sub>HYST</sub>:** Hysteresis Window,  $|B_{OP} - B_{RP}|$

### 8 Feature Description

The MT613X series is sensitive to the magnetic field that is parallel to the package (X & Y axis). To operate the MR switch, the magnetic field should be applied to the sensor parallel to the package. MT613X series detect the magnetic field in any parallel direction, but it does not respond to magnetic field in the vertical direction.

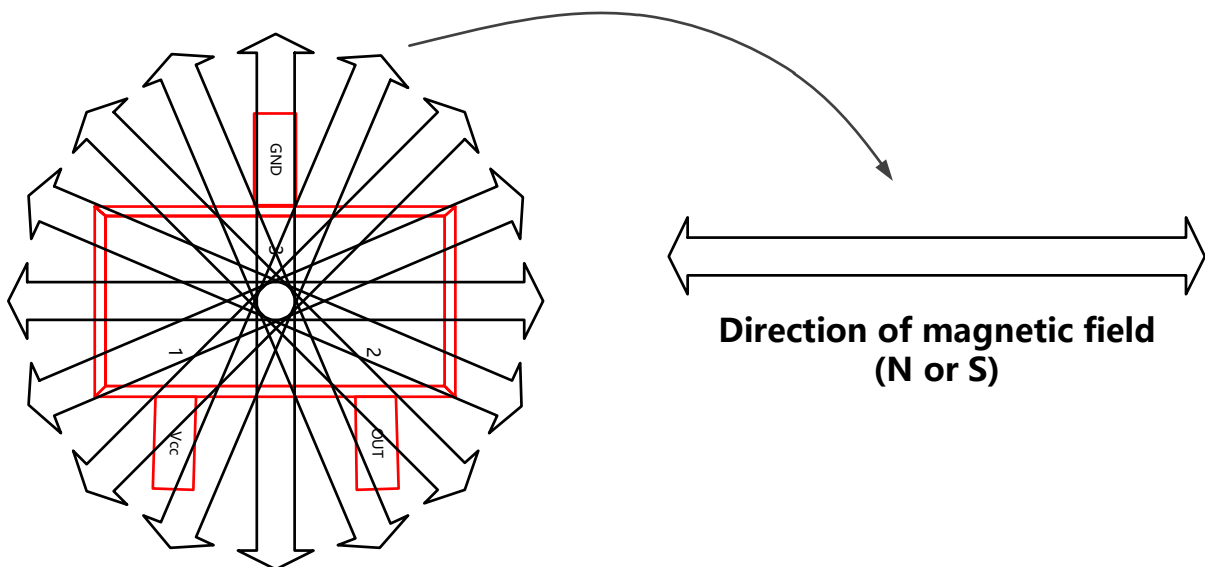

Figure.3 Detection of magnetic field

### 9 Functional Block Diagram

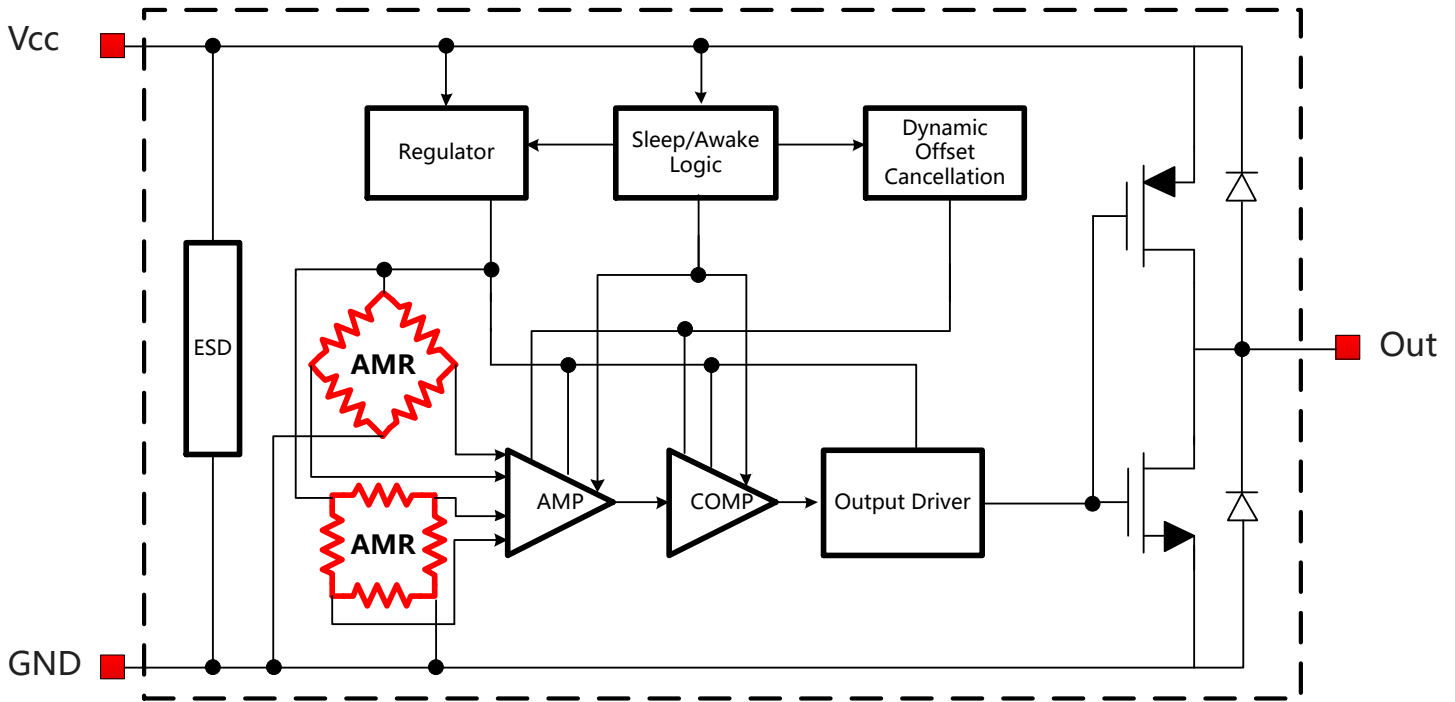

Figure.4 Functional Block Diagram (MT6131 & MT6132)

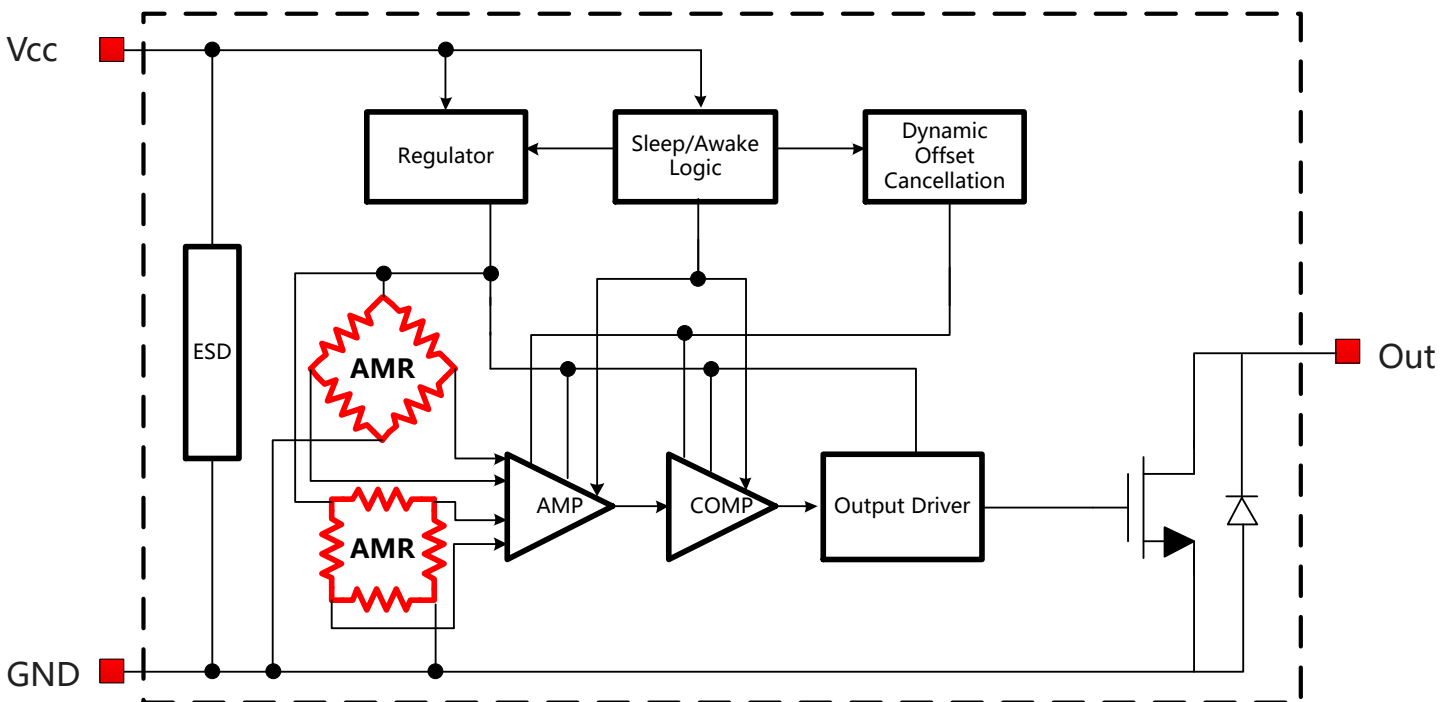

Figure.5 Functional Block Diagram (MT6133 & MT6135)

## 10 Electrical and Magnetic Characteristics

### 10.1 Absolute Maximum Ratings

Absolute maximum ratings are limited values to be applied individually, and beyond which the serviceability of the circuit may be impaired. Functional operability is not necessarily implied. Exposure to absolute maximum rating conditions for an extended period of time may affect device reliability.

Symbol	Parameters	Min	Max	Units
V <sub>CC</sub>	Supply Voltage	-	7	V
V <sub>RCC</sub>	Reverse Battery Voltage	-0.4	-	V
V <sub>OUT</sub>	Output Voltage	-	7	V
I <sub>OUT</sub>	Continuous Output Current	-	20	mA
T <sub>A</sub>	Operating Ambient Temperature	-40	125	°C
T <sub>S</sub>	Storage Temperature	-50	150	°C
T <sub>J</sub>	Junction Temperature	-	165	°C
B	Magnetic Flux Density		1200	Gs

### 10.2 Electrical Specifications

At T<sub>A</sub>=-40~125°C, V<sub>CC</sub>=1.65V~5.0V (unless otherwise specified)

Symbol	Parameters	Test Condition	Min	Typ	Max	Unit
V <sub>CC</sub>	Supply Voltage	Operating	1.65	3.60	5.00	V
I <sub>CC</sub>	Supply Current	MT6131 & MT6133, V <sub>CC</sub> =3.6V,  B  <  B <sub>RP</sub>	1.0	2.0	3.0	uA
		MT6132 & MT6135, V <sub>CC</sub> =3.6V,  B  <  B <sub>RP</sub>	10.0	15.0	20.0	uA
V <sub>OH</sub>	Output High Voltage	MT6131 & MT6132, V <sub>CC</sub> =5V, I <sub>OUT</sub> =5mA,  B  >  B <sub>OP</sub>	4.6	-	-	V
V <sub>OL</sub>	Output Low Voltage	V <sub>CC</sub> =5V, I <sub>OUT</sub> =-5mA,  B  >  B <sub>OP</sub>	-	-	0.4	V
I <sub>OFF</sub>	Output Leakage Current	V <sub>OUT</sub> =5V,  B  <  B <sub>RP</sub>	-	-	0.1	uA
T <sub>PO</sub>	Power on Time	dV <sub>CC</sub> /dt > 3.6V/us, B > B <sub>OP</sub> (MAX)	-	80	120	us
F <sub>OP</sub>	Operation Frequency	MT6131 & MT6133, V <sub>CC</sub> =3.6V	10	20	-	Hz
		MT6132 & MT6135, V <sub>CC</sub> =3.6V	0.5K	1K	-	Hz
T <sub>AW</sub>	Awake Time	V <sub>CC</sub> =3.6V	-	16	-	us
T <sub>SL</sub>	Sleep Time	V <sub>CC</sub> =3.6V	-	50	-	ms
D.C.	Duty Cycle	V <sub>CC</sub> =3.6V	-	0.03	-	%
R <sub>TH</sub>	Thermal Resistance of SOT-23		-	301	-	°C/W

### 10.3 Magnetic Characteristics

At  $T_A = 25^\circ\text{C}$ ,  $V_{CC} = 1.65\text{V} \sim 5.0\text{V}$  (unless otherwise specified)

Part No.	Symbol	Min	Typ	Max	Unit
MT613X Series	BOP	$\pm 8$	$\pm 18$	$\pm 28$	Gs
	BRP	$\pm 3$	$\pm 13$	$\pm 23$	Gs
	BHYST	3	5	8	Gs

### 10.4 ESD Ratings

Symbol	Reference	Values	Unit
$V_{ESD}$	Human-body model (HBM)	4000	V
	Charged-device model (CDM)	1000	V

### 10.5 Characteristic Performance

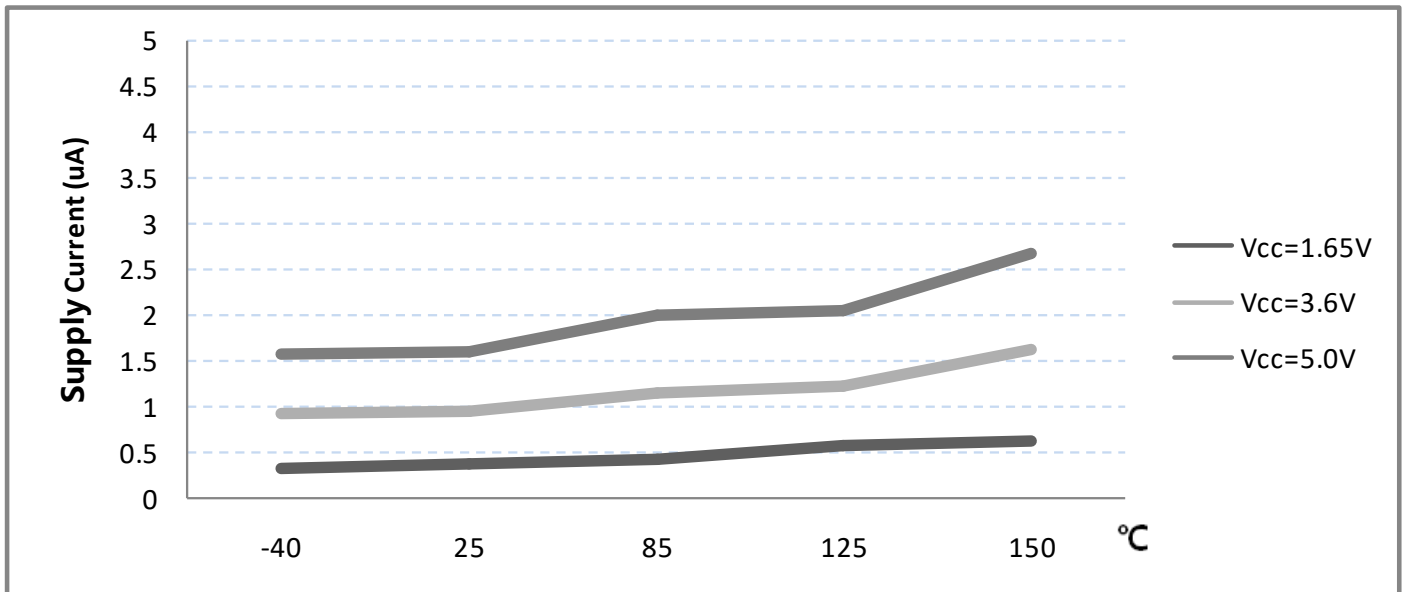

Figure.6 Supply Current vs. Temperature

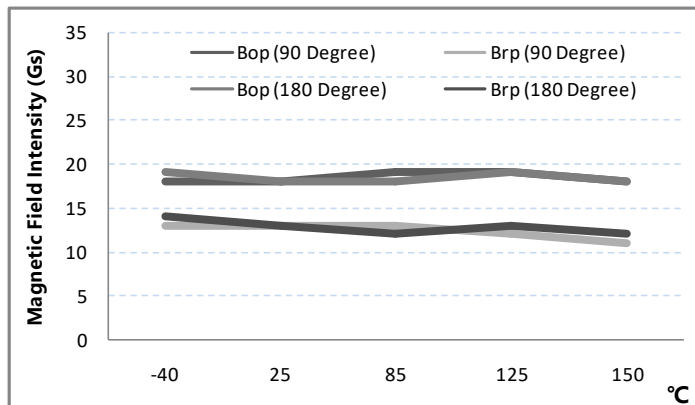

Figure.7 Magnetic Characteristics vs. Temperature (BOP & BRP) (At  $V_{CC} = 3.6\text{V}$ )  
Magnetic Field @ 90 Degree & 180 Degree

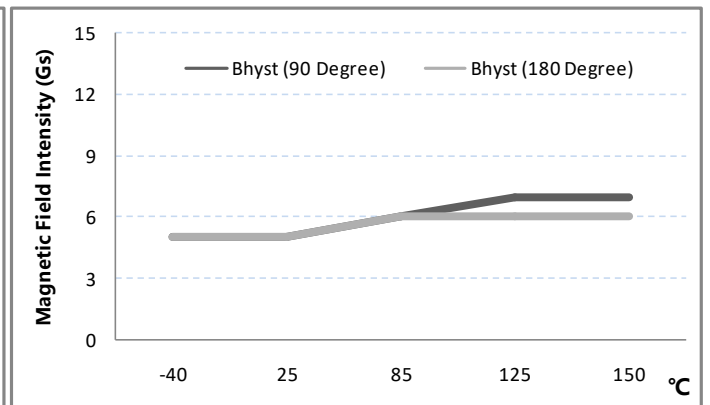

Figure.8 Magnetic Characteristics vs. Temperature (BHYST) (At  $V_{CC} = 3.6\text{V}$ )  
Magnetic Field @ 90 Degree & 180 Degree

### 10.5 Characteristic Performance (continued)

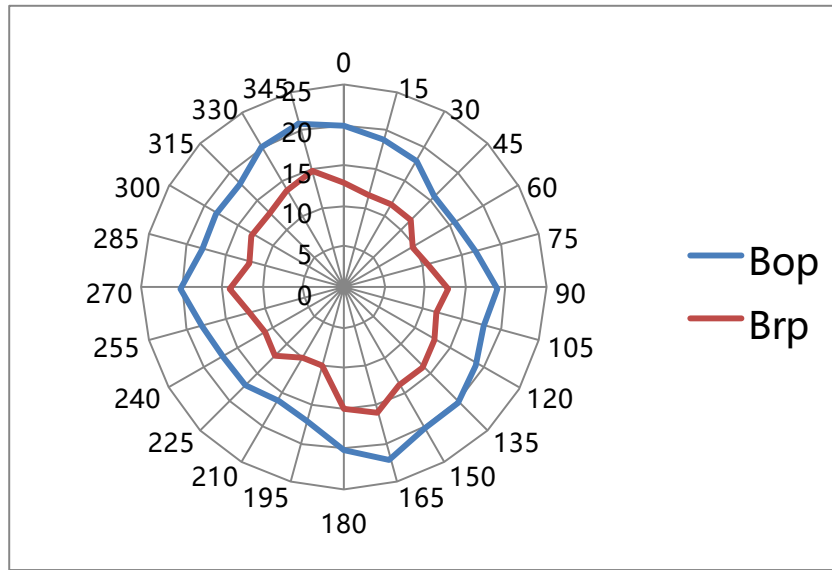
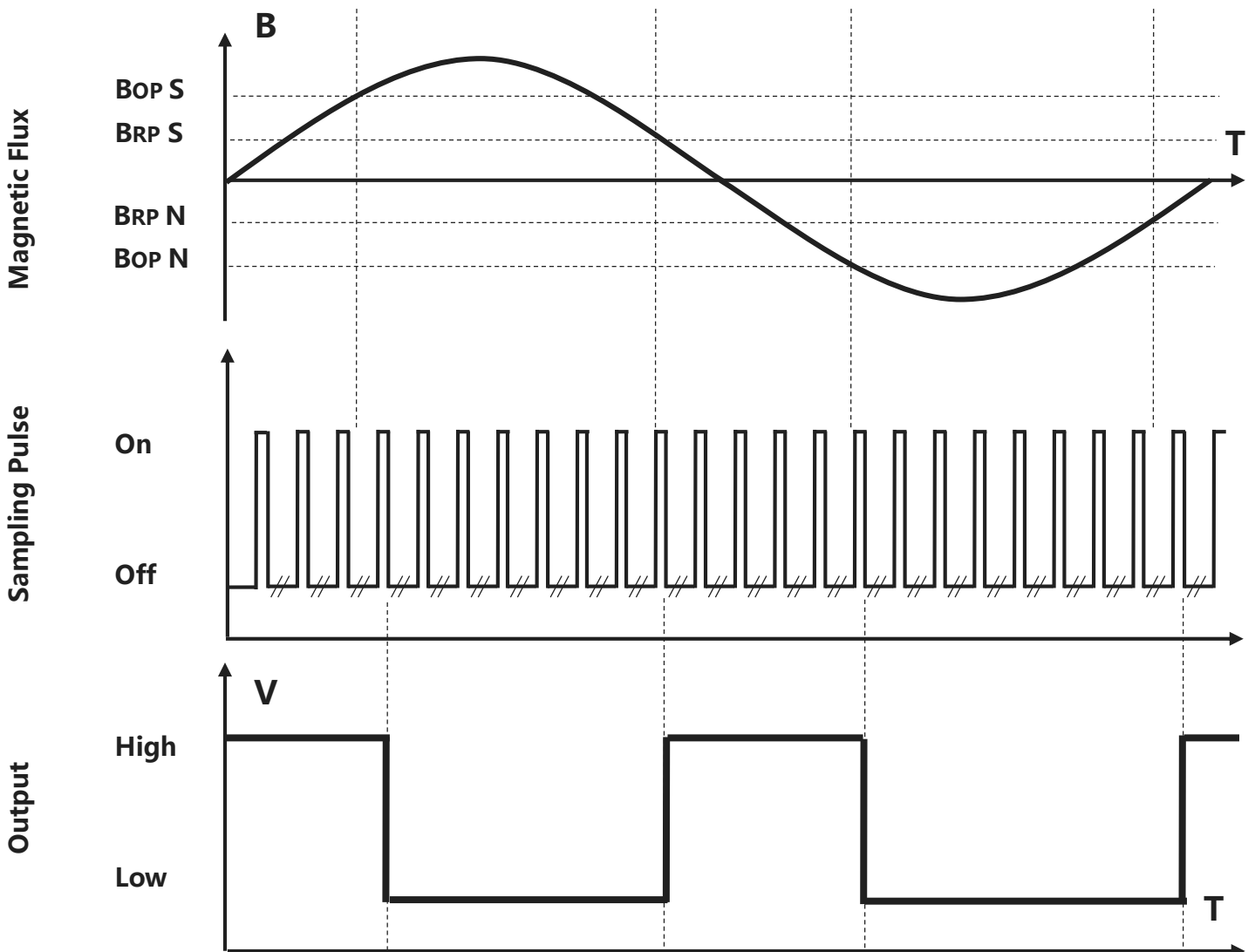

Figure.9 360 Degree Magnetic Characteristics (At Vcc=3.6V, TA=25 °C)

### 10.6 Typical Output Waveform

MT6131A as example



Note: Output is not immediately updated until the chip wakes up from sleep mode and samples the input

Figure.10 Digital Output vs. Magnetic Flux Density & Sampling Pulse

### 11 Typical Application Circuit

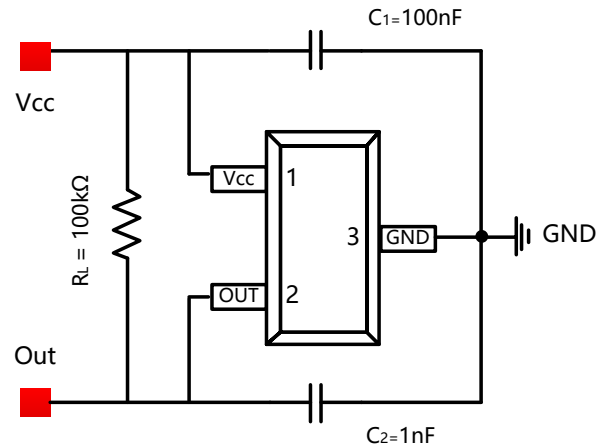
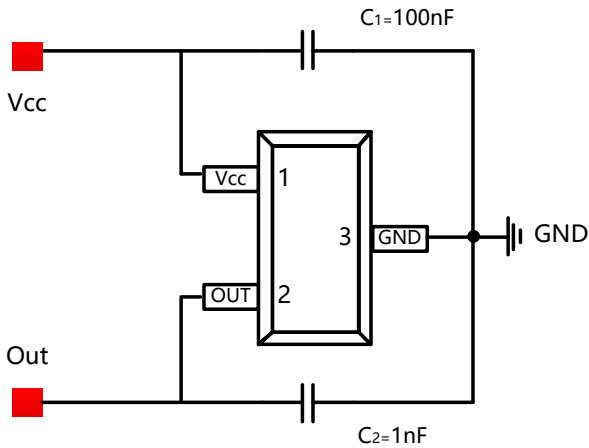
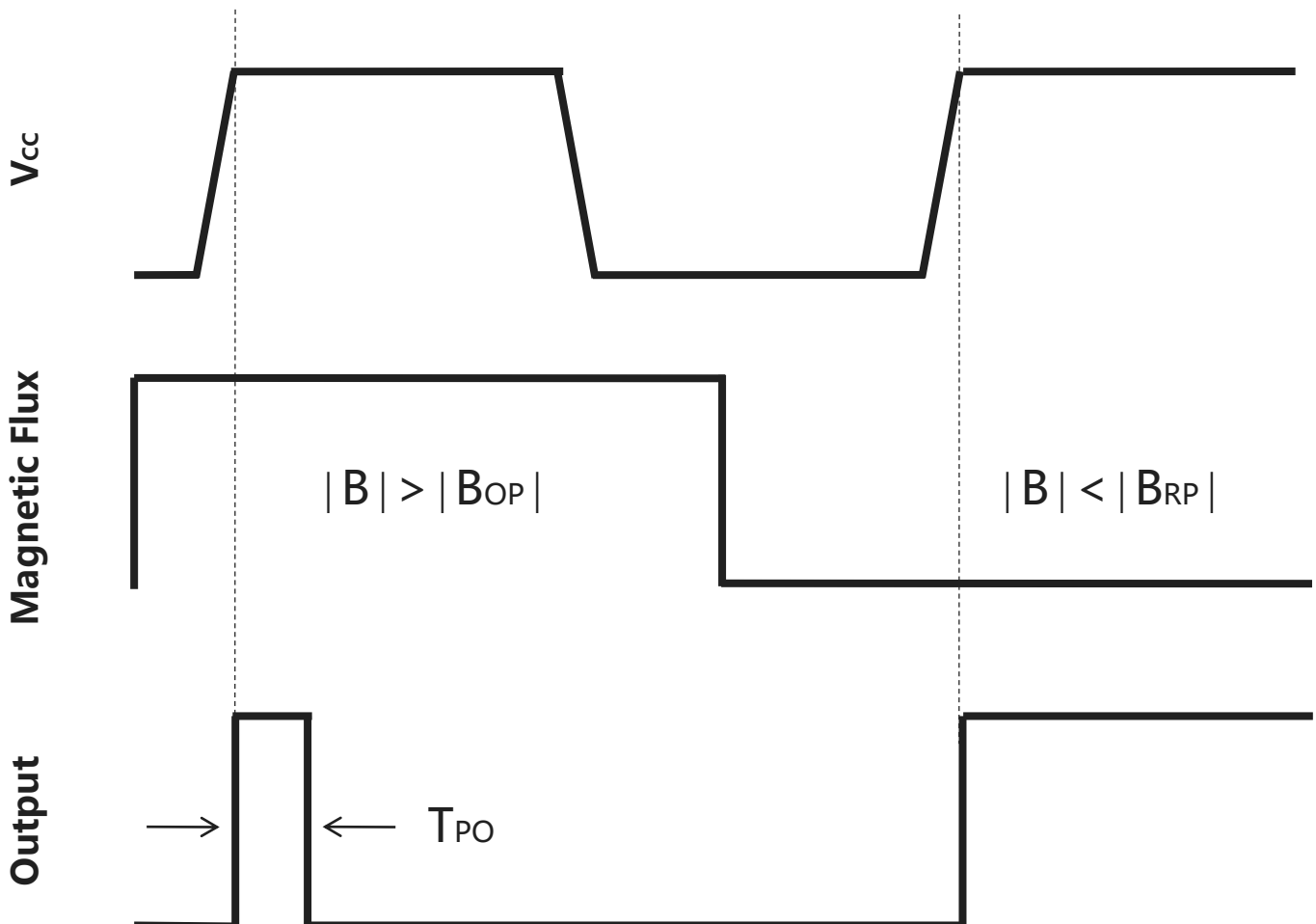

**Figure.11** Typical Application Circuit  
Push Pull Output  
MT6131 & MT 6132

**Figure.12** Typical Application Circuit  
Open Drain Output  
MT6133 & MT 6135

### 12 Power on Output Waveform

$V_{CC}$  rise time  $< 1\mu s$ ,  $T_{PO}$  is the time from the stable point of  $V_{CC}$  to the valid point of output



**Figure.13** Power on Output Waveform



### 13 Package Material Information (For Reference Only – Not for Tooling Use)

#### 13.1 SOT-23 Package Information

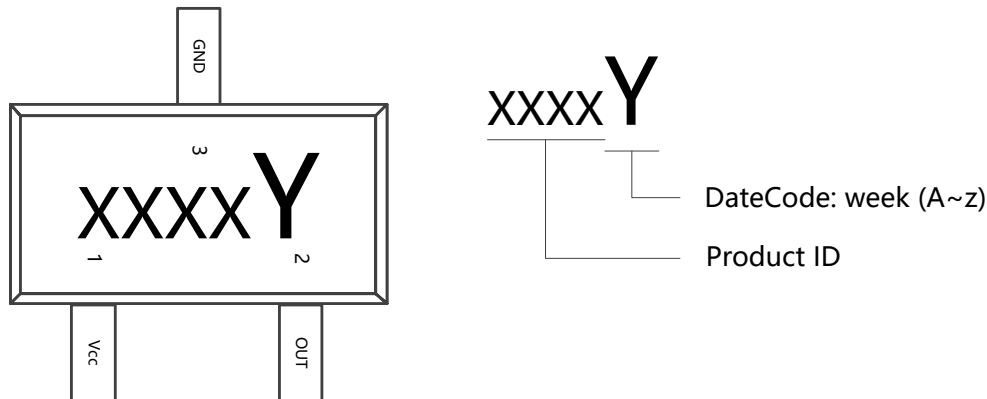

Figure.14 SOT-23 Chip Marking Spec

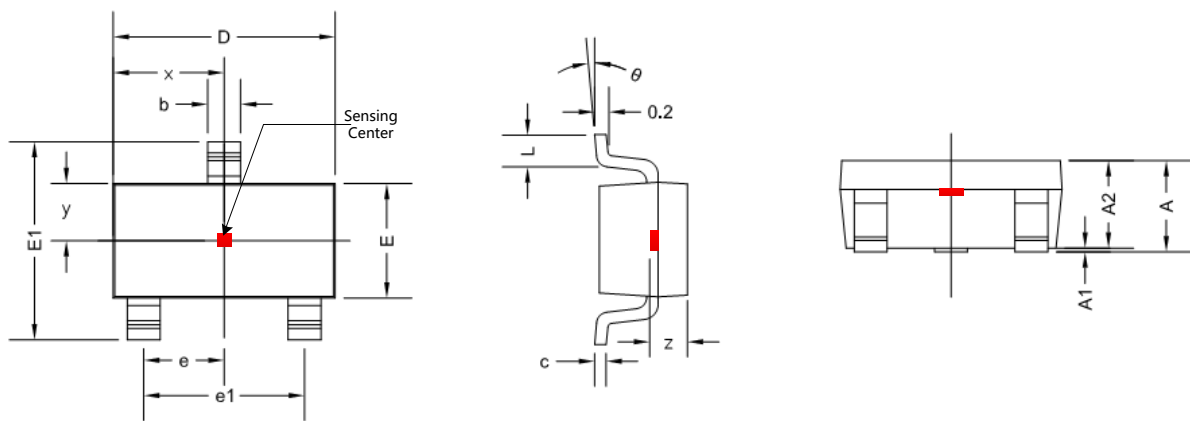

Figure.15 SOT-23 Package Drawing

Symbol	Dimensions in Millimeters		Dimensions in Inches	
	Min	Max	Min	Max
A	1.050	1.250	0.041	0.049
A1	0.000	0.100	0.000	0.004
A2	1.050	1.150	0.041	0.045
b	0.300	0.500	0.012	0.020
c	0.100	0.200	0.004	0.008
D	2.820	3.020	0.111	0.119
E	1.500	1.700	0.059	0.067
E1	2.650	2.950	0.104	0.116
e	0.950 TYP		0.037 TYP	
e1	1.800	2.000	0.071	0.079
L	0.300	0.600	0.012	0.024
θ	0 °	8 °	0 °	8 °
x	1.460 TYP		0.057 TYP	
y	0.800 TYP		0.032 TYP	
z	0.600 TYP		0.024 TYP	

单击下面可查看定价，库存，交付和生命周期等信息

[>>Magntek\(麦歌恩\)](#)