

## Omni-polar, Nano Power Hall-Effect Switch IC

### 1 Product Description

The MT863X family is produced with CMOS technology. The Hall IC internally includes high sensitivity horizontal hall plates, sleep/awake logics for mode control, a low-power on-chip oscillator, low noise analog signal chain with dynamic offset cancellation, hysteresis comparators and an output driver.

The product responds to either North pole or South pole magnetic fields. The output will be turned on (Low) when the magnetic flux density (B) is larger than the operating point (BOP), and be turned off (High) when the magnetic flux density (B) is lower than the releasing point (BRP).

The MT863X family provides a variety of packages to customers: SOT-23-3L for surface mount and flat TO-92 for through-hole mount. All packages are RoHS compliant.

### 2 Features

- CMOS Technology
- Omni-polar Switch
- 2.0~5.5V Operating Vcc Range
- -40°C~125°C Operating Temperature
- Package Option:
  - SOT-23-3L
  - Flat TO-92
- Magnetic Sensitivity Option:
  - MT8631 : BOP=±37Gs, BRP=±25Gs
  - MT8632 : BOP=±15Gs, BRP=±9Gs
- Push Pull Output
- Nano Power Consumption:
  - Average Supply Current =600nA (Vcc=2.0V)
- RoHS Compliant: (EU)2015/863

### 3 Product Overview of MT863X

| Part No. | Description                              |
|----------|--|
| MT863XA  | Flat TO-92, bulk packaging (1000pcs/bag) |
| MT863XAT | SOT-23-3L, tape & reel (3000pcs/bag)     |

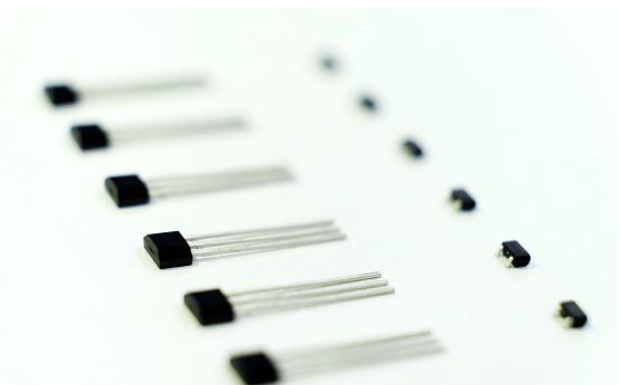

### 4 Applications

- Home appliances, Industrial
- Position Detection
- Solid-State Switch
- Proximity Switch
- Smart Meter
- Handheld Device
- Consumer Device

### 5. Pin Configuration and Functions

|             | Vcc   | Out                 | GND    |
|-------------|-------|---------------------|--------|
| SOT-23-3L   | 1     | 2                   | 3      |
| Flat TO-92  | 1     | 3                   | 2      |
| Description | Power | Output<br>Push Pull | Ground |

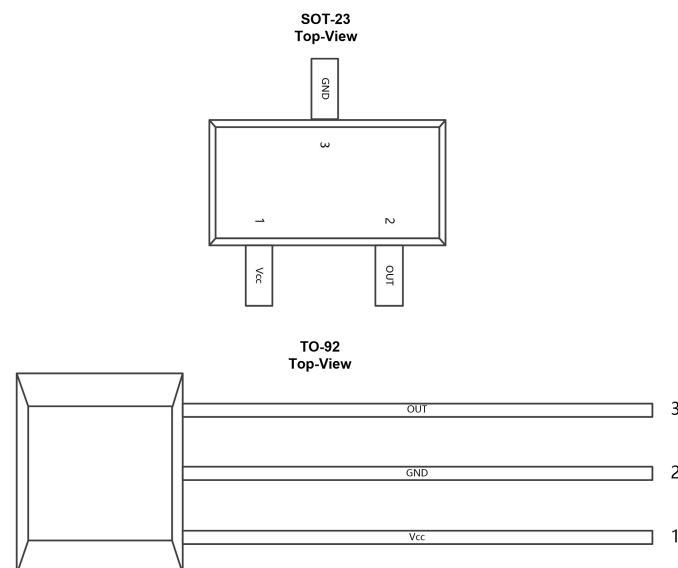

Figure.1 Pin Configuration & Functions

## Table of Contents

|    |  |    |
|----|--|----|
| 1  | Product Description.....                     | 1  |
| 2  | Features.....                                | 1  |
| 3  | Product Overview of MT863X .....             | 1  |
| 4  | Applications.....                            | 1  |
| 5  | Pin Configuration and Functions.....         | 1  |
| 6  | Definition of Switching Function.....        | 3  |
| 7  | Function Description.....                    | 3  |
| 8  | Feature Description.....                     | 3  |
| 9  | Functional Block Diagram.....                | 4  |
| 10 | Electrical and Magnetic Characteristics..... | 4  |
|    | 10.1 Absolute Maximum Ratings.....           | 4  |
|    | 10.2 Electrical Specifications.....          | 5  |
|    | 10.3 Magnetic Characteristics.....           | 5  |
|    | 10.4 ESD Ratings.....                        | 5  |
|    | 10.5 Characteristic Performance.....         | 6  |
|    | 10.6 Typical Output Waveform.....            | 7  |
| 11 | Typical Application Circuit.....             | 7  |
| 12 | Package Material Information.....            | 8  |
|    | 12.1 SOT-23-3L Package Information.....      | 8  |
|    | 12.2 Flat TO-92 Package Information.....     | 9  |
| 13 | Copy Rights and Disclaimer.....              | 10 |

## Reversion History

|   |                    |  |
|---|--------------------|--|
| 1 | Originally Version |  |
| 2 | 1.1 Version        | Tighten the B <sub>OP</sub> max spec from 57Gs to 55Gs<br>Tighten the B <sub>HYST</sub> max spec from 21Gs to 18Gs |
| 3 | 1.2 Version        | Update the I <sub>AW</sub> max spec from 4mA to 5mA  |
| 4 | 1.3 Version        | Add MT8632 Series  |

## 6 Definition of Switching Function

Figure.2 shows the device functionality and hysteresis

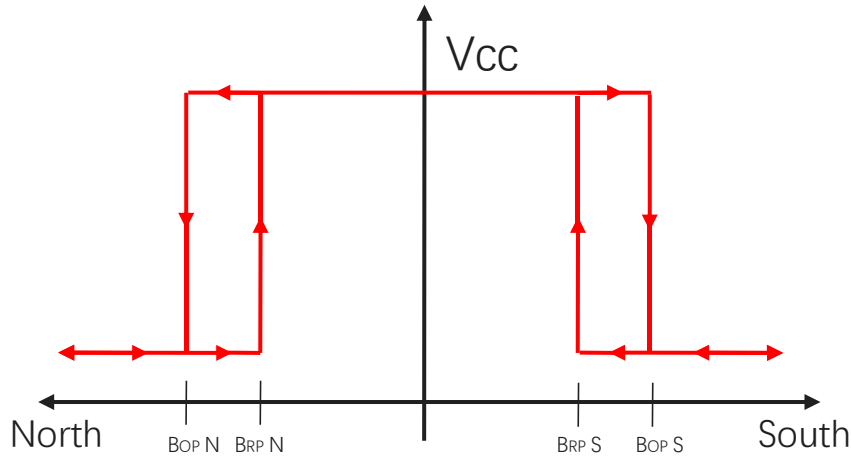

Figure.2 Omni-polar Switching Function

## 7 Function Description

**B<sub>OP</sub>:** Operating Point, Magnetic flux density applied on the branded side of the package which turns the output driver ON ( $V_{OUT}=Low$ )

**B<sub>RP</sub>:** Releasing Point, Magnetic flux density applied on the branded side of the package which turns the output driver OFF ( $V_{OUT}=High$ )

**B<sub>HYST</sub>:** Hysteresis Window,  $|B_{OP} - B_{RP}|$

Devices that have a lower magnetic threshold ( $V_{OUT}=High$ ) detect magnets at a farther distance. Higher thresholds ( $V_{OUT}=Low$ ) generally require a closer distance or larger magnet.

## 8 Feature Description

The MT863X device is sensitive to the magnetic field component that is perpendicular to the top of the package

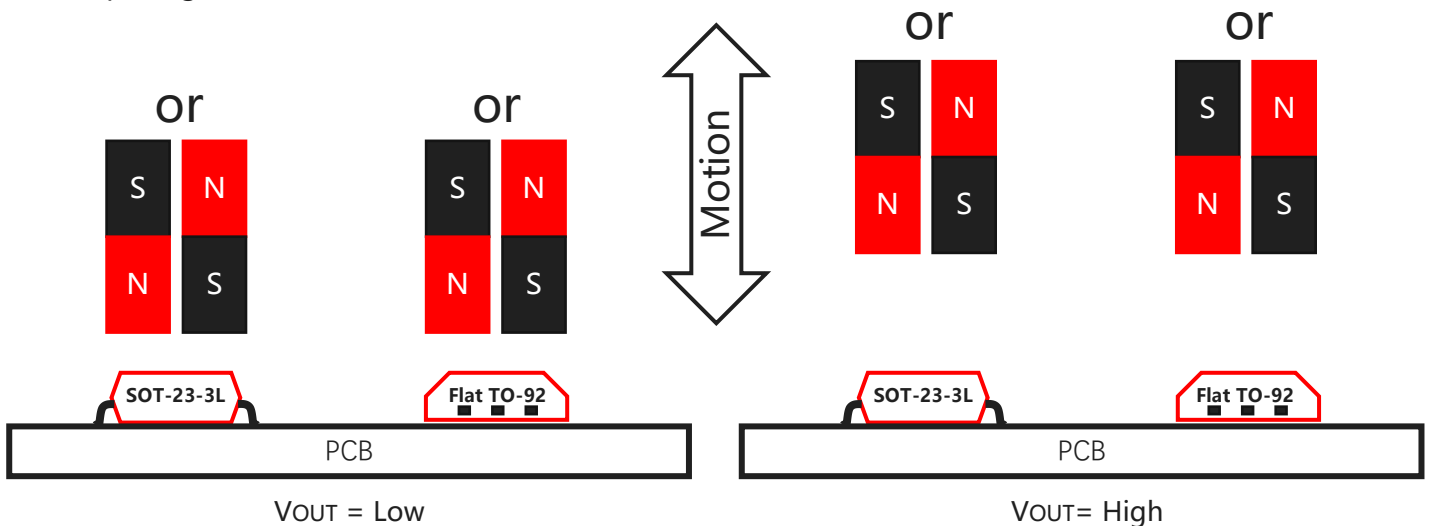

Figure.3 Flux Direction Polarity

## 9 Functional Block Diagram

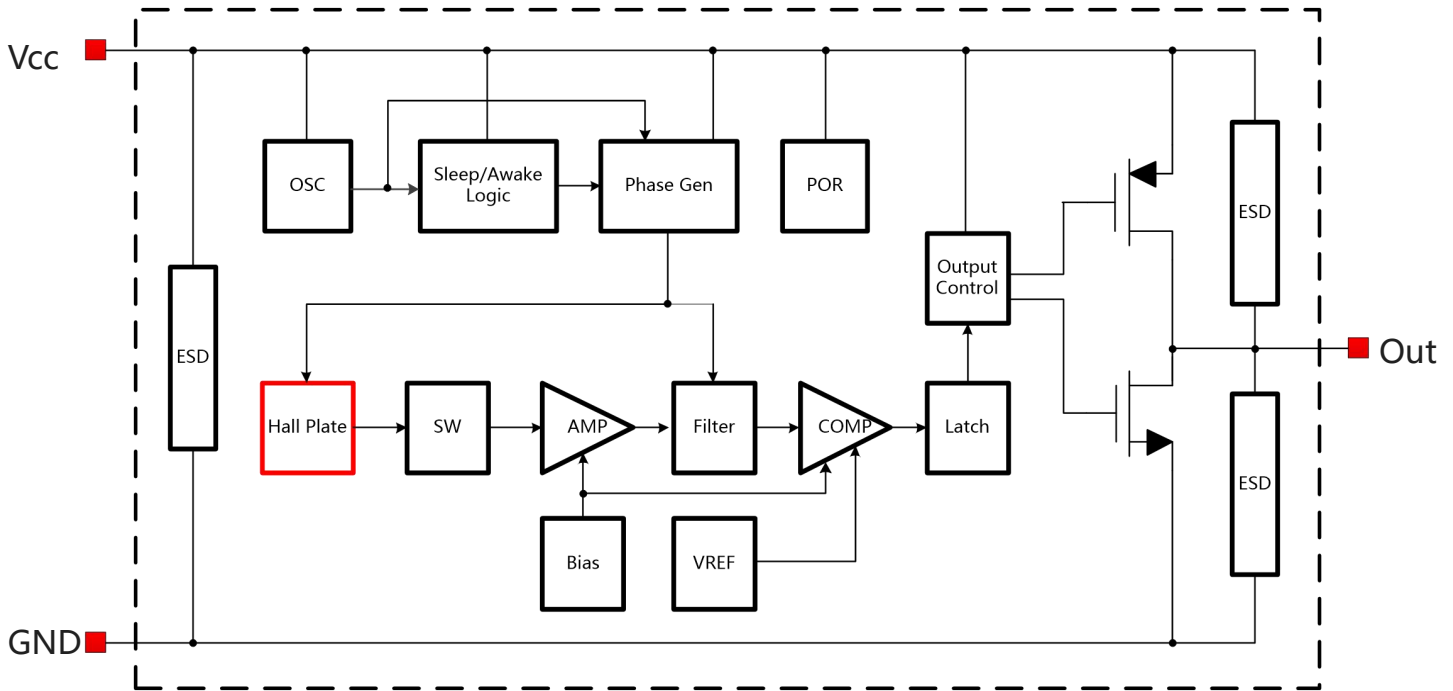

Figure.4 Functional Block Diagram

## 10 Electrical and Magnetic Characteristics

### 10.1 Absolute Maximum Ratings

Absolute maximum ratings are limited values to be applied individually, and beyond which the serviceability of the circuit may be impaired. Functional operability is not necessarily implied. Exposure to absolute maximum rating conditions for an extended period of time may affect device reliability.

| Symbol | Parameters                    | Min      | Max | Units |
|--------|-------------------------------|----------|-----|-------|
| VCC    | Supply Voltage                | -        | 7   | V     |
| VRCC   | Reverse Battery Voltage       | -0.5     | -   | V     |
| VOUT   | Output Voltage                | -        | 7   | V     |
| IOUT   | Continuous Output Current     | -        | 8   | mA    |
| TA     | Operating Ambient Temperature | -40      | 125 | °C    |
| TS     | Storage Temperature           | -50      | 150 | °C    |
| TJ     | Junction Temperature          | -        | 165 | °C    |
| B      | Magnetic Flux Density         | No Limit |     | Gs    |

## 10.2 Electrical Specifications

At  $T_A = -40 \sim 125^\circ\text{C}$ ,  $V_{CC} = 2.0\text{V} \sim 5.5\text{V}$  (unless otherwise specified)

| Symbol   | Parameters                       | Test Condition   | Min            | Typ  | Max | Unit                      |
|----------|----------------------------------|--|----------------|------|-----|---------------------------|
| $V_{CC}$ | Supply Voltage                   | Operating  | 2.0            | 3.6  | 5.5 | V                         |
| $I_{CC}$ | Supply Current                   | $V_{CC} = 3.6\text{V}$                                     | -              | 1.2  | 2.0 | $\mu\text{A}$             |
|          |                                  | $V_{CC} = 2.0\text{V}$                                     | -              | 600  | -   | nA                        |
| $I_{AW}$ | Awake Current                    | $V_{CC} = 3.6\text{V}$                                     | -              | 3.0  | 5.0 | mA                        |
| $I_{SL}$ | Sleep Current                    | $V_{CC} = 3.6\text{V}$                                     | -              | 1.2  | 2.0 | $\mu\text{A}$             |
| $V_{OL}$ | Output Low Voltage               | $I_{OUT} = 5\text{mA}$ , $ B  >  B_{OP} $                  | -              | -    | 0.4 | V                         |
| $V_{OH}$ | Output High Voltage              | $I_{OUT} = 5\text{mA}$ , $ B  <  B_{RP} $                  | $V_{CC} - 0.4$ | -    | -   | V                         |
| $F_{SW}$ | Switching Frequency              | $V_{CC} = 3.6\text{V}$                                     | 10             | 20   | 40  | Hz                        |
| $T_{AW}$ | Awake Time                       | $V_{CC} = 2.0\text{V}$ to $5.5\text{V}$                    | 4              | 10   | 16  | $\mu\text{s}$             |
| $T_{SL}$ | Sleep Time                       | $V_{CC} = 2.0\text{V}$ to $5.5\text{V}$                    | 25             | 50   | 100 | ms                        |
| D.C.     | Duty Cycle                       | $V_{CC} = 2.0\text{V}$ to $5.5\text{V}$                    | -              | 0.02 | -   | %                         |
| $T_{PO}$ | Power on Time                    | $dV_{CC}/dt > 5\text{V}/\mu\text{s}$ ,<br>$ B  >  B_{OP} $ | -              | -    | 120 | $\mu\text{s}$             |
| $R_{TH}$ | Thermal Resistance of SOT-23-3L  |  | -              | 301  | -   | $^\circ\text{C}/\text{W}$ |
|          | Thermal Resistance of Flat TO-92 |  | -              | 230  | -   | $^\circ\text{C}/\text{W}$ |

## 10.3 Magnetic Characteristics

At  $V_{CC} = 2.0\text{V} \sim 5.5\text{V}$  (unless otherwise specified)

| Part No.      | Symbol                          | Min      | Typ      | Max      | Unit |
|---------------|---------------------------------|----------|----------|----------|------|
| MT8631 Series | BOP, $T_A = 25^\circ\text{C}$   | $\pm 17$ | $\pm 37$ | $\pm 55$ | Gs   |
|               | BRP, $T_A = 25^\circ\text{C}$   | $\pm 10$ | $\pm 25$ | $\pm 40$ | Gs   |
|               | BHYST, $T_A = 25^\circ\text{C}$ | 3        | 12       | 18       | Gs   |
| MT8632 Series | BOP, $T_A = 25^\circ\text{C}$   | $\pm 8$  | $\pm 16$ | $\pm 24$ | Gs   |
|               | BRP, $T_A = 25^\circ\text{C}$   | $\pm 2$  | $\pm 9$  | $\pm 16$ | Gs   |
|               | BHYST, $T_A = 25^\circ\text{C}$ | -        | 7        | -        | Gs   |

## 10.4 ESD Ratings

| Symbol    | Reference                  | Values       | Unit       |   |
|-----------|----------------------------|--------------|------------|---|
| $V_{ESD}$ | Human-body model (HBM)     | AEC-Q100-002 | $\pm 5000$ | V |
|           | Charged-device model (CDM) | AEC-Q100-011 | $\pm 1000$ | V |

### 10.5 Characteristic Performance

At  $V_{CC}=3.6V$

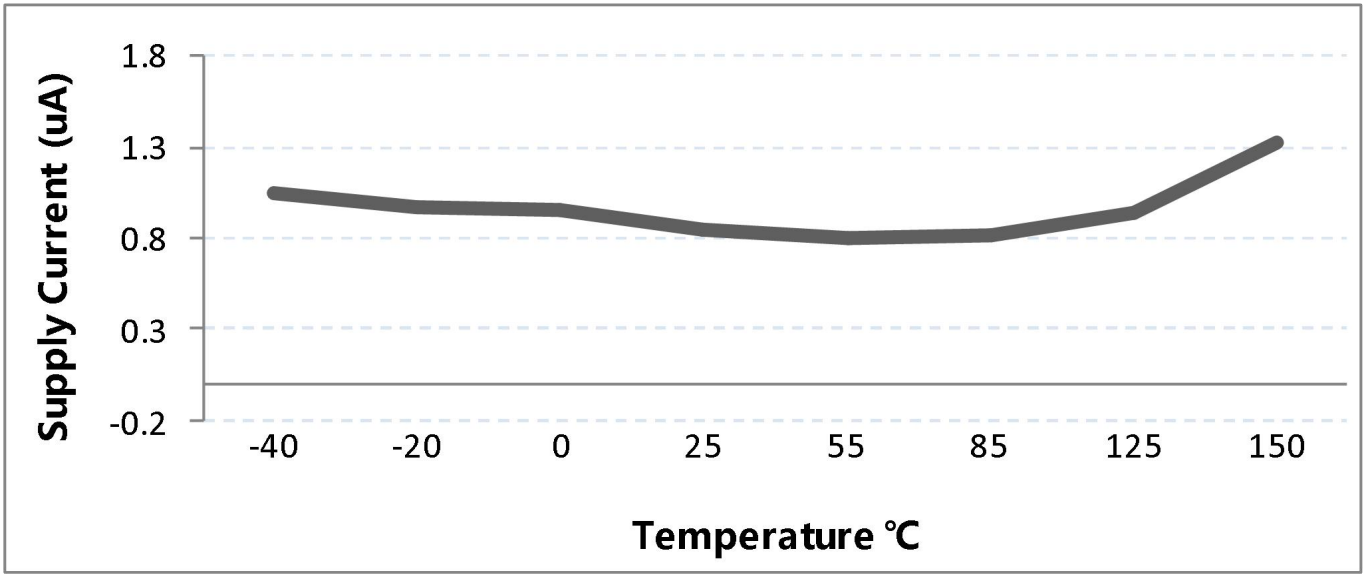

Figure.5 Supply Current vs. Temperature

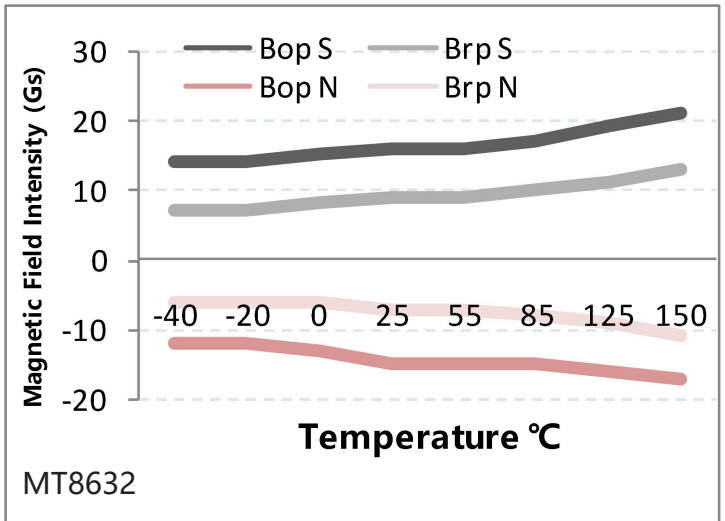
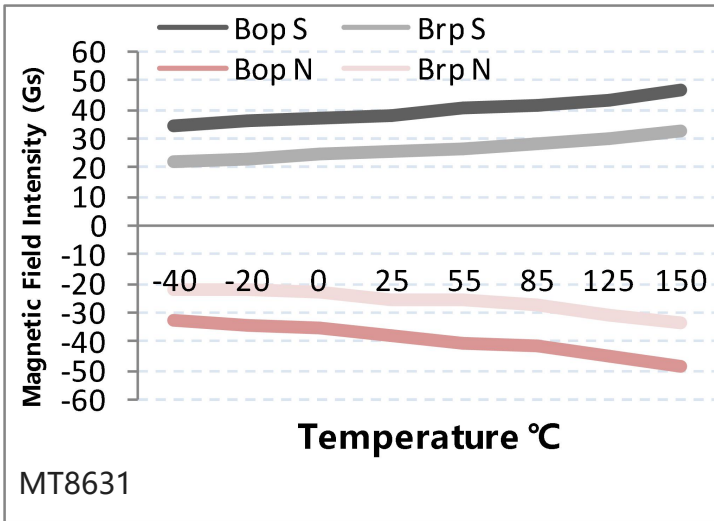

Figure.6 Magnetic Characteristics vs. Temperature (BOP & BRP)

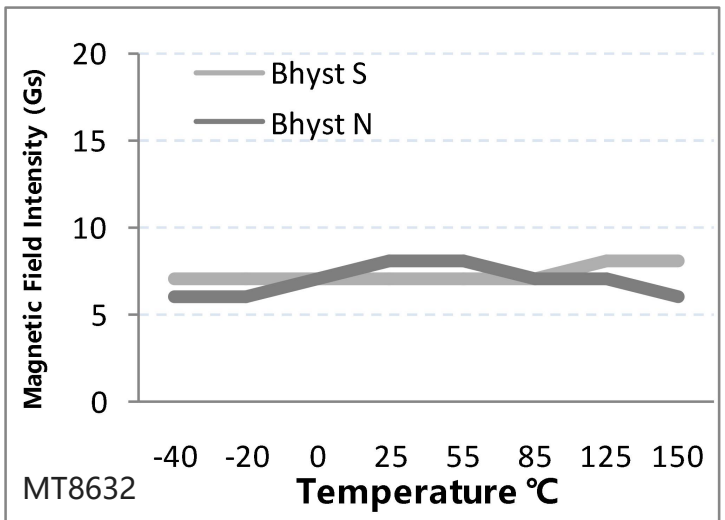
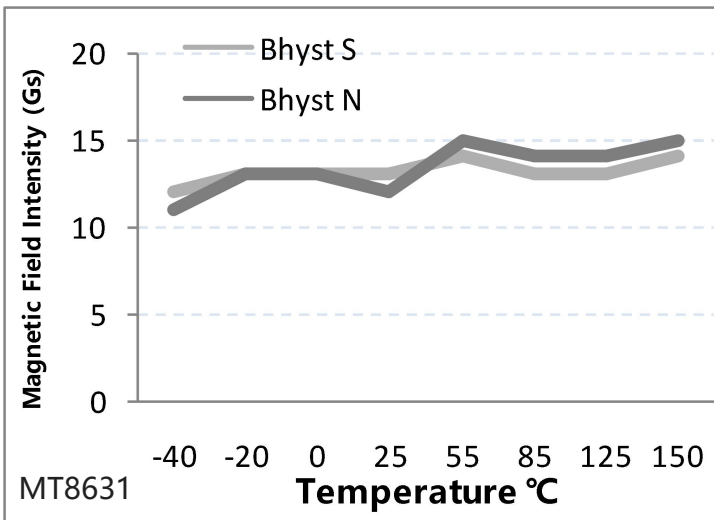

Figure.7 Magnetic Characteristics vs. Temperature (BHYST)

### 10.6 Typical Output Waveform

MT8631A as example

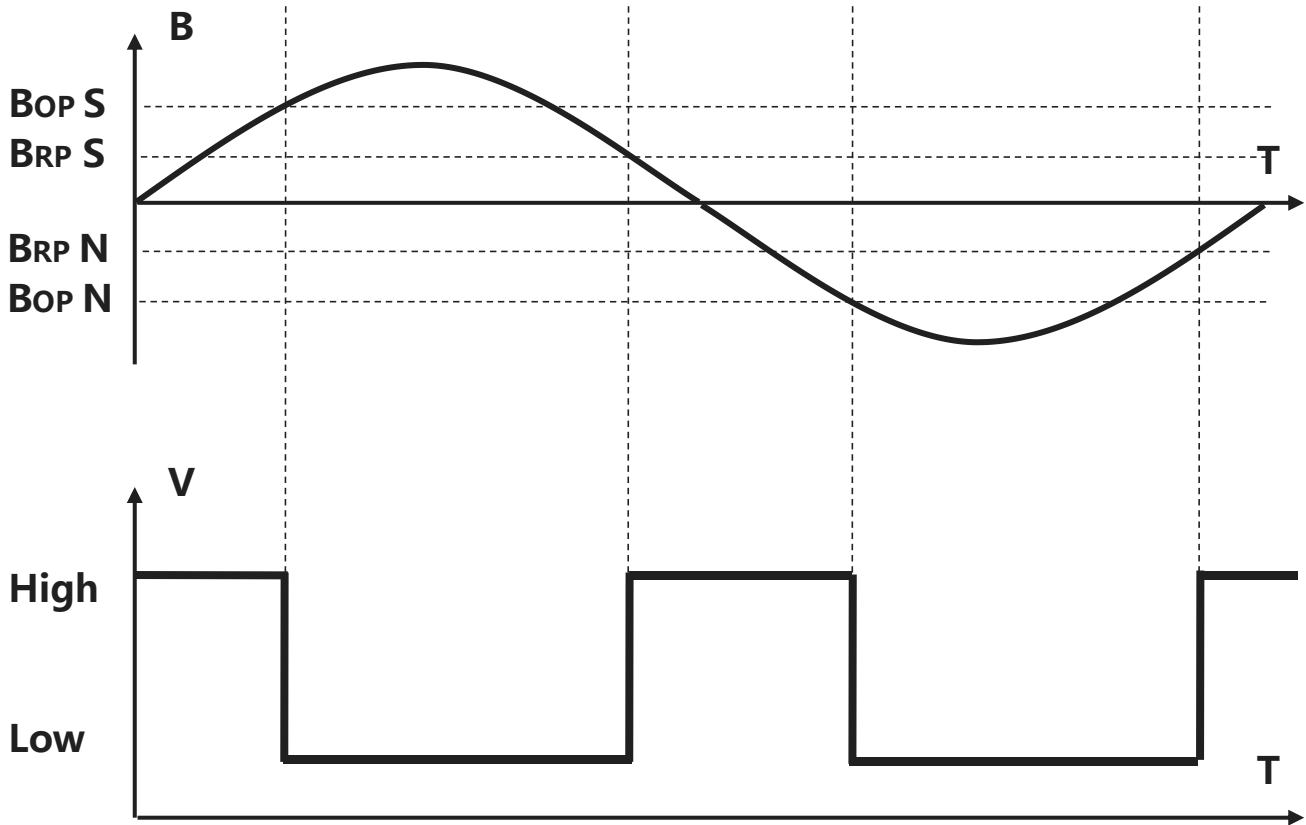

Figure.8 Digital Output vs. Magnetic Flux Density

### 11 Typical Application Circuit

MT8631AT as example

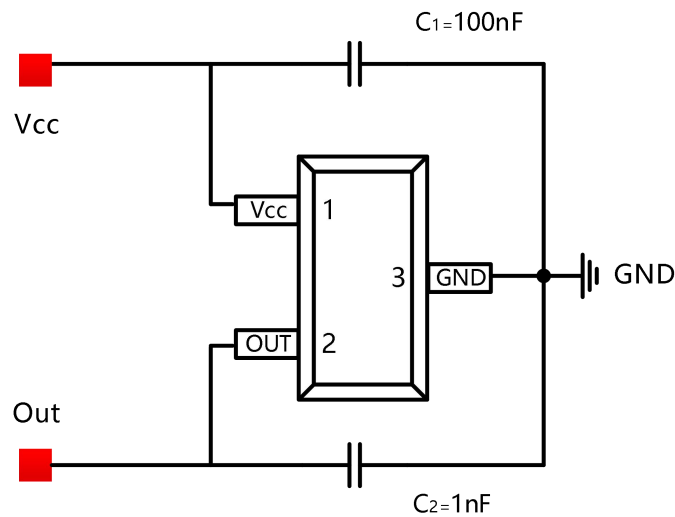

Figure.9 Typical Application Circuit

12 Package Material Information ( For Reference Only – Not for Tooling Use )

12.1 SOT-23-3L Package Information

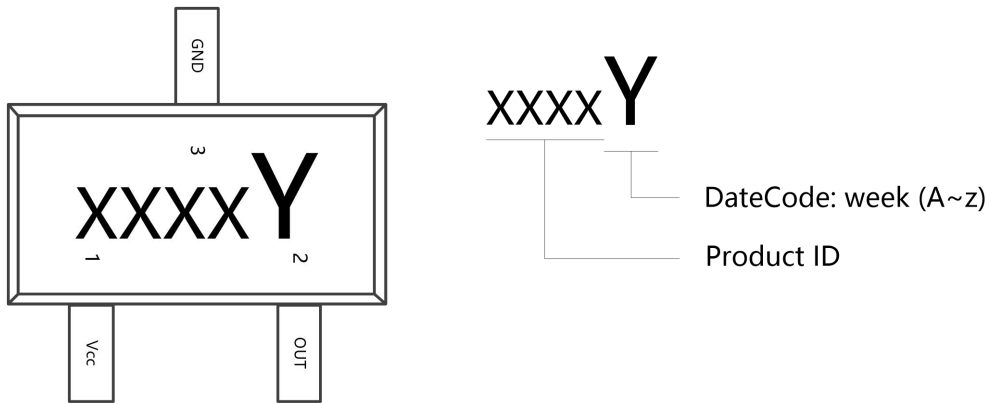

Figure.10 SOT-23-3L Chip Marking Spec

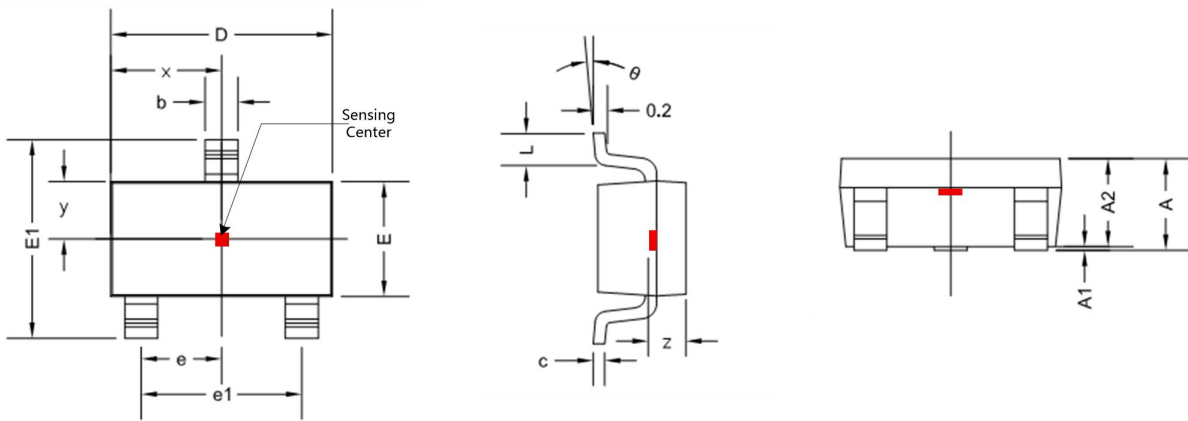

Figure.11 SOT-23-3L Package Drawing

| Symbol | Dimensions in Millimeters |       | Dimensions in Inches |        |
|--------|---------------------------|-------|----------------------|--------|
|        | Min                       | Max   | Min                  | Max    |
| A      | -                         | 1.300 | -                    | 0.0512 |
| A1     | 0.000                     | 0.150 | 0.0000               | 0.0059 |
| A2     | 1.000                     | 1.200 | 0.0394               | 0.0472 |
| b      | 0.300                     | 0.500 | 0.0118               | 0.0197 |
| c      | 0.080                     | 0.220 | 0.0031               | 0.0087 |
| D      | 2.800                     | 3.000 | 0.1102               | 0.1181 |
| E      | 1.500                     | 1.700 | 0.0591               | 0.0669 |
| E1     | 2.600                     | 3.000 | 0.1024               | 0.1181 |
| e      | 0.870                     | 1.030 | 0.0343               | 0.0406 |
| e1     | 1.820                     | 1.980 | 0.0717               | 0.0780 |
| L      | 0.300                     | 0.600 | 0.0118               | 0.0236 |
| θ      | 0 °                       | 8 °   | 0 °                  | 8 °    |
| x      | 1.450 TYP                 |       | 0.057 TYP            |        |
| y      | 0.800 TYP                 |       | 0.032 TYP            |        |
| z      | 0.600 TYP                 |       | 0.024 TYP            |        |



## 12.2 Flat TO-92 Package Information

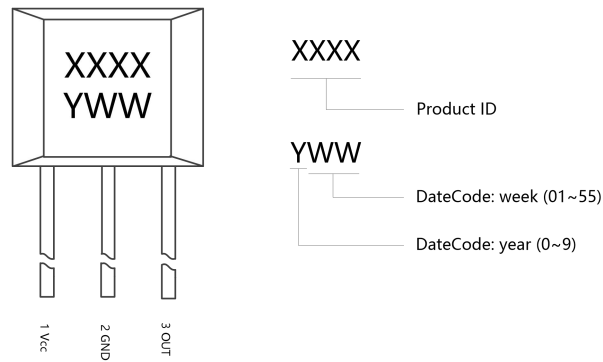

Figure.12 Flat TO-92 Chip Marking Spec

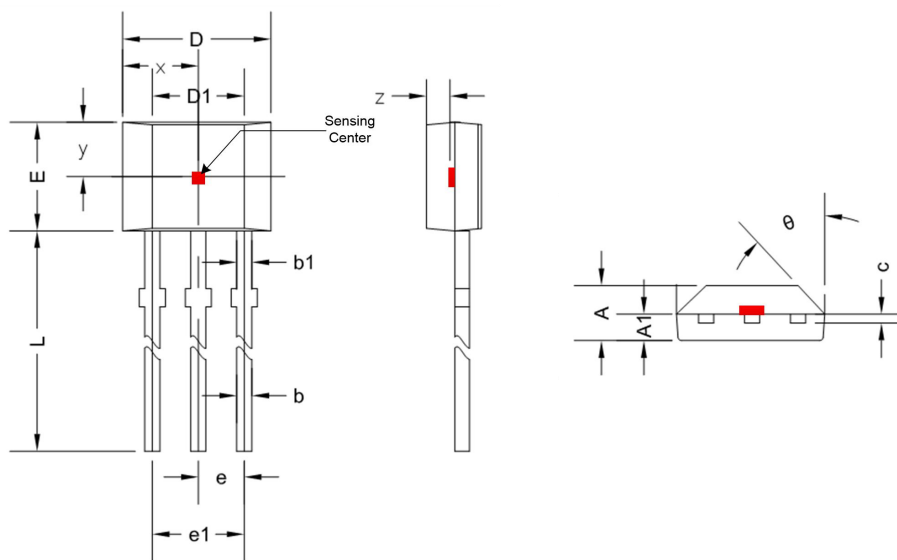

Figure.13 Flat TO-92 Package Drawing

| Symbol   | Dimensions in Millimeters |        | Dimensions in Inches |       |
|----------|---------------------------|--------|----------------------|-------|
|          | Min                       | Max    | Min                  | Max   |
| A        | 1.420                     | 1.620  | 0.056                | 0.064 |
| A1       | 0.660                     | 0.860  | 0.026                | 0.034 |
| b        | 0.350                     | 0.480  | 0.013                | 0.019 |
| b1       | 0.400                     | 0.510  | 0.016                | 0.020 |
| c        | 0.330                     | 0.510  | 0.013                | 0.020 |
| D        | 3.900                     | 4.100  | 0.154                | 0.161 |
| D1       | 2.280                     | 2.680  | 0.090                | 0.106 |
| E        | 3.050                     | 3.250  | 0.120                | 0.128 |
| e        | 1.270 TYP                 |        | 0.050 TYP            |       |
| e1       | 2.440                     | 2.640  | 0.096                | 0.104 |
| L        | 14.350                    | 14.750 | 0.565                | 0.581 |
| $\theta$ | 45 ° TYP                  |        | 45 ° TYP             |       |
| x        | 2.025 TYP                 |        | 0.080 TYP            |       |
| y        | 1.545 TYP                 |        | 0.061 TYP            |       |
| z        | 0.500 TYP                 |        | 0.020 TYP            |       |

### 13 Copy Rights and Disclaimer

1. This document may not be reproduced or duplicated, in any form, in whole or in part without prior written consent of MagnTek . Copyrights © 2019, MagnTek Incorporated.
2. MagnTek reserves the right to make changes to the information published in this document at anytime without notice.
3. MagnTek' s products are limited for use in normal commercial applications. MagnTek' s products are not to be used in any device or system, including but not limited to medical life support equipment and system.

For the latest version of this document, please visit our website: [www.magntek.com.cn](http://www.magntek.com.cn)

单击下面可查看定价，库存，交付和生命周期等信息

[>>Magntek\(麦歌恩\)](#)