



SLP32N20C / SLF32N20C 200V N-Channel MOSFET

SLP32N20C / SLF32N20C

General Description

This Power MOSFET is produced using True semi's advanced planar stripe DMOS technology. This advanced technology has been especially tailored to minimize on-state resistance, provide superior switching performance, and withstand high energy pulse in the avalanche and commutation mode. These devices are well suited for high efficiency switched mode power supplies, active power factor correction based on half bridge topology.

Features

- 32A, 200V, $R_{DS(on) typ.} = 0.080\Omega @ V_{GS} = 10V$
- Low gate charge (typical 50 nC)
- High ruggedness
- Fast switching
- 100% avalanche tested
- Improved dv/dt capability

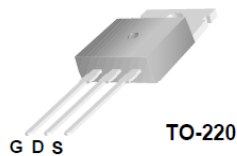

TO-220

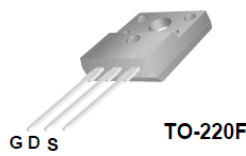

TO-220F

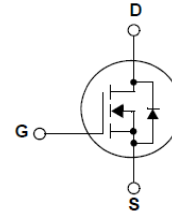

Absolute Maximum Ratings T_C = 25°C unless otherwise noted

Symbol	Parameter	SLP32N20C	SLF32N20C	Units
V _{DSS}	Drain-Source Voltage	200		V
I _D	Drain Current - Continuous (T _C = 25°C)	32	32 *	A
	- Continuous (T _C = 100°C)	19.2	19.2 *	A
I _{DM}	Drain Current - Pulsed (Note 1)	128	128 *	A
V _{GSS}	Gate-Source Voltage	±30		V
E _{AS}	Single Pulsed Avalanche Energy (Note 2)	1120		mJ
I _{AR}	Avalanche Current (Note 1)	32		A
E _{AR}	Repetitive Avalanche Energy (Note 1)	25.6		mJ
dv/dt	Peak Diode Recovery dv/dt (Note 3)	4.5		V/ns
P _D	Power Dissipation (T _C = 25°C)	256	41.8	W
	- Derate above 25°C	2.05	0.34	W/°C
T _J , T _{STG}	Operating and Storage Temperature Range	-55 to +150		°C
T _L	Maximum lead temperature for soldering purposes, 1/8" from case for 5 seconds	300		°C

* Drain current limited by maximum junction temperature.

Thermal Characteristics

Symbol	Parameter	SLP32N20C	SLF32N20C	Units
R _{θJC}	Thermal Resistance, Junction-to-Case	0.49	3.0	°C/W
R _{θJS}	Thermal Resistance, Case-to-Sink Typ.	0.5	--	°C/W
R _{θJA}	Thermal Resistance, Junction-to-Ambient	62.5	62.5	°C/W

Electrical Characteristics $T_C = 25^\circ\text{C}$ unless otherwise noted

Symbol	Parameter	Test Conditions	Min	Typ	Max	Units
Off Characteristics						
BV_{DSS}	Drain-Source Breakdown Voltage	$V_{GS} = 0\text{ V}, I_D = 250\text{ }\mu\text{A}$	200	--	--	V
$\frac{\Delta BV_{DSS}}{\Delta T_J}$	Breakdown Voltage Temperature Coefficient	$I_D = 250\text{ }\mu\text{A}$, Referenced to 25°C	--	0.2	--	$\text{V}/^\circ\text{C}$
I_{DSS}	Zero Gate Voltage Drain Current	$V_{DS} = 200\text{ V}, V_{GS} = 0\text{ V}$	--	--	1	μA
		$V_{DS} = 160\text{ V}, T_C = 125^\circ\text{C}$	--	--	10	μA
I_{GSSF}	Gate-Body Leakage Current, Forward	$V_{GS} = 30\text{ V}, V_{DS} = 0\text{ V}$	--	--	100	nA
I_{GSSR}	Gate-Body Leakage Current, Reverse	$V_{GS} = -30\text{ V}, V_{DS} = 0\text{ V}$	--	--	-100	nA
On Characteristics						
$V_{GS(th)}$	Gate Threshold Voltage	$V_{DS} = V_{GS}, I_D = 250\text{ }\mu\text{A}$	2.0	--	4.0	V
$R_{DS(on)}$	Static Drain-Source On-Resistance	$V_{GS} = 10\text{ V}, I_D = 16\text{ A}$	--	0.080	0.1	Ω
g_{FS}	Forward Transconductance	$V_{DS} = 40\text{ V}, I_D = 16\text{ A}$ (Note 4)	--	22	--	S
Dynamic Characteristics						
C_{iss}	Input Capacitance	$V_{DS} = 25\text{ V}, V_{GS} = 0\text{ V},$ $f = 1.0\text{ MHz}$	--	1560	--	pF
C_{oss}	Output Capacitance		--	370	--	pF
C_{riss}	Reverse Transfer Capacitance		--	150	--	pF
Switching Characteristics						
$t_{d(on)}$	Turn-On Delay Time	$V_{DD} = 100\text{ V}, I_D = 32\text{ A},$ $R_G = 25\text{ }\Omega$ (Note 4, 5)	--	26	--	ns
t_r	Turn-On Rise Time		--	32	--	ns
$t_{d(off)}$	Turn-Off Delay Time		--	141	--	ns
t_f	Turn-Off Fall Time		--	83	--	ns
Q_g	Total Gate Charge	$V_{DS} = 160\text{ V}, I_D = 32\text{ A},$ $V_{GS} = 10\text{ V}$ (Note 4, 5)	--	50	--	nC
Q_{gs}	Gate-Source Charge		--	12	--	nC
Q_{gd}	Gate-Drain Charge		--	22	--	nC
Drain-Source Diode Characteristics and Maximum Ratings						
I_S	Maximum Continuous Drain-Source Diode Forward Current		--	--	32	A
I_{SM}	Maximum Pulsed Drain-Source Diode Forward Current		--	--	128	A
V_{SD}	Drain-Source Diode Forward Voltage	$V_{GS} = 0\text{ V}, I_S = 32\text{ A}$	--	--	1.4	V
t_{rr}	Reverse Recovery Time	$V_{GS} = 0\text{ V}, I_S = 32\text{ A},$	--	215	--	ns
Q_{rr}	Reverse Recovery Charge	$di_F / dt = 100\text{ A}/\mu\text{s}$ (Note 4)	--	1.8	--	μC

Notes:

1. Repetitive Rating : Pulse width limited by maximum junction temperature
2. $L = 1.45\text{ mH}, I_{AS} = 32\text{ A}, V_{DD} = 50\text{ V}, R_G = 25\text{ }\Omega$, Starting $T_J = 25^\circ\text{C}$
3. $I_{SD} \leq 32\text{ A}, di/dt \leq 200\text{ A}/\mu\text{s}, V_{DD} \leq BV_{DSS}$, Starting $T_J = 25^\circ\text{C}$
4. Pulse Test : Pulse width $\leq 300\text{ }\mu\text{s}$, Duty cycle $\leq 2\%$
5. Essentially independent of operating temperature

Typical Characteristics

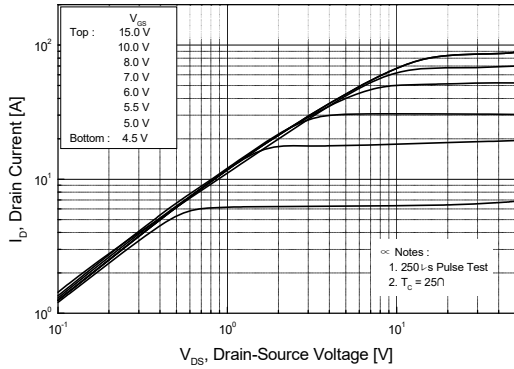

Figure 1. On-Region Characteristics

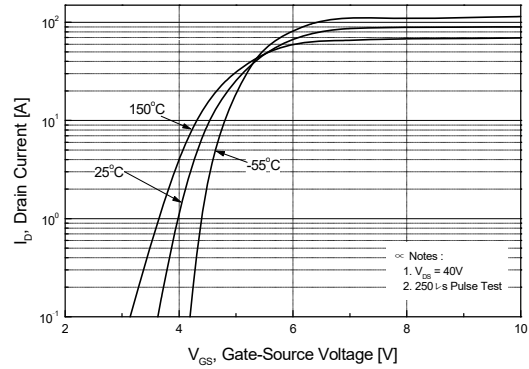

Figure 2. Transfer Characteristics

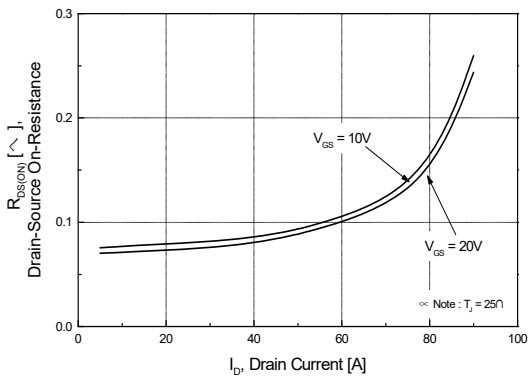

Figure 3. On-Resistance Variation vs Drain Current and Gate Voltage

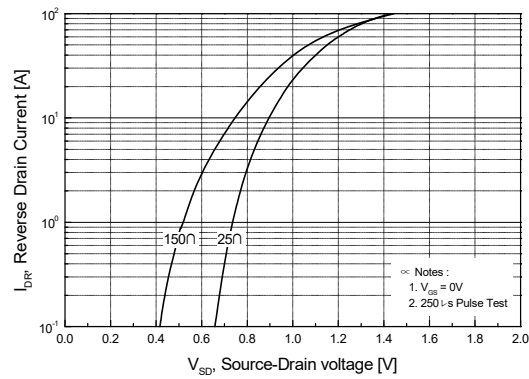

Figure 4. Body Diode Forward Voltage Variation with Source Current and Temperature

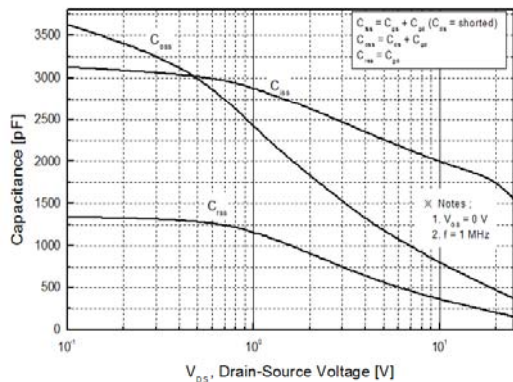

Figure 5. Capacitance Characteristics

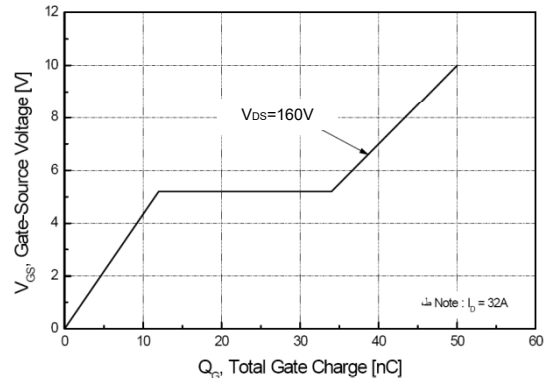

Figure 6. Gate Charge Characteristics

Typical Characteristics (Continued)

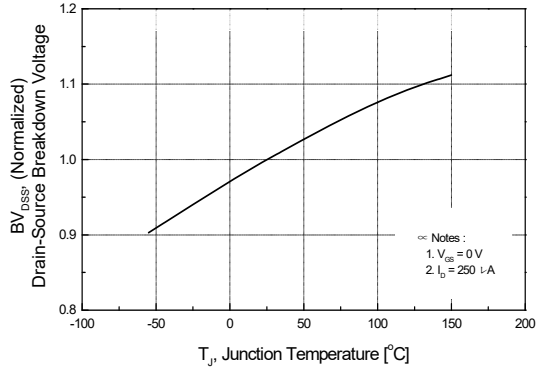

Figure 7. Breakdown Voltage Variation vs Temperature

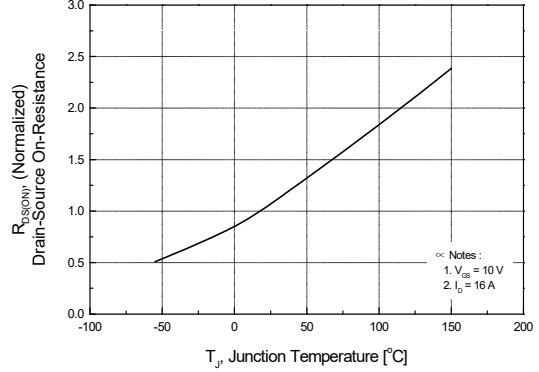

Figure 8. On-Resistance Variation vs Temperature

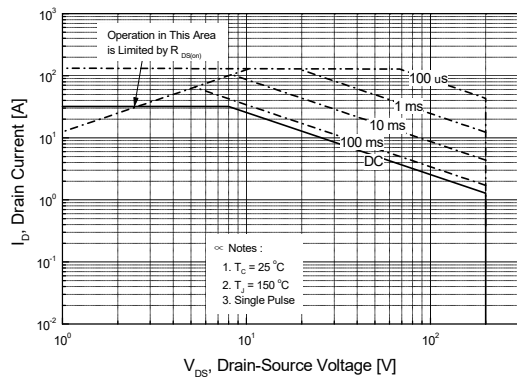

Figure 9-1. Maximum Safe Operating Area for SLP32N20C

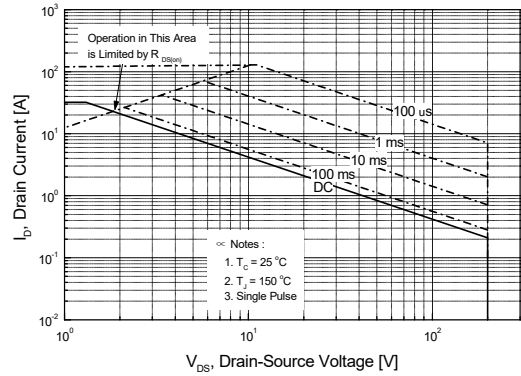

Figure 9-2. Maximum Safe Operating Area for SLF32N20C

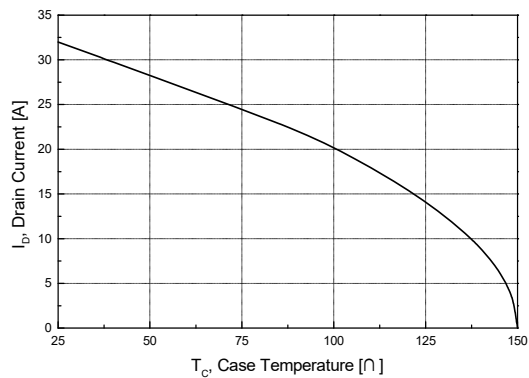

Figure 10. Maximum Drain Current vs Case Temperature

Typical Characteristics

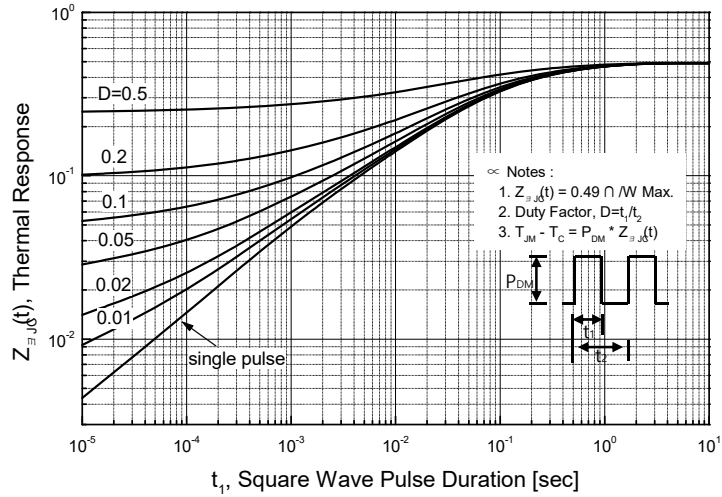

Figure 11-1. Transient Thermal Response Curve for SLP32N20C

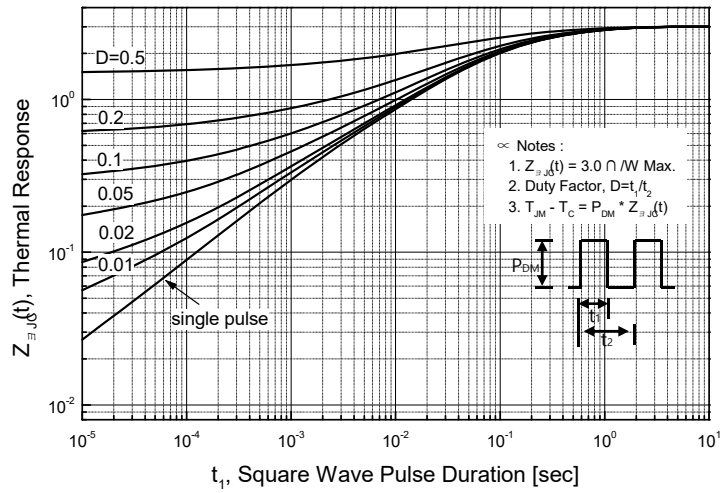
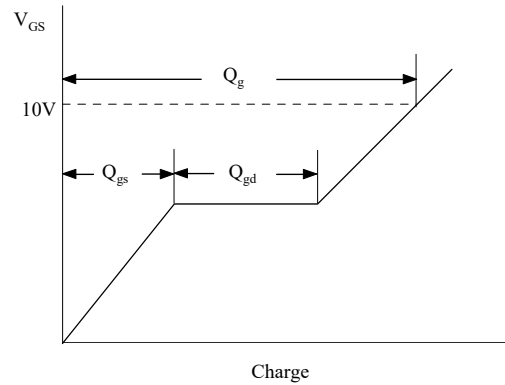
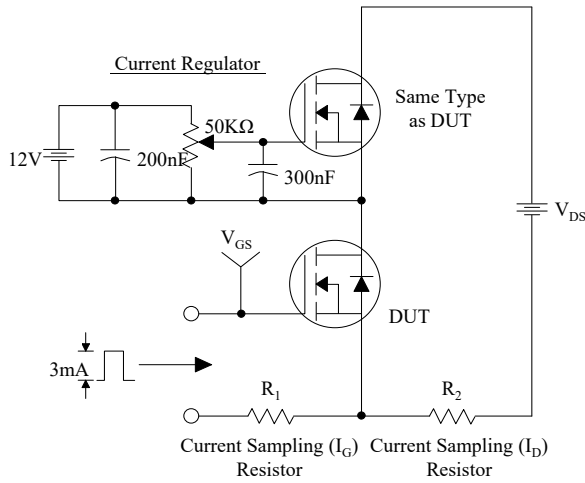
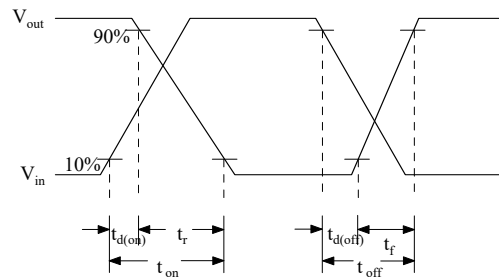
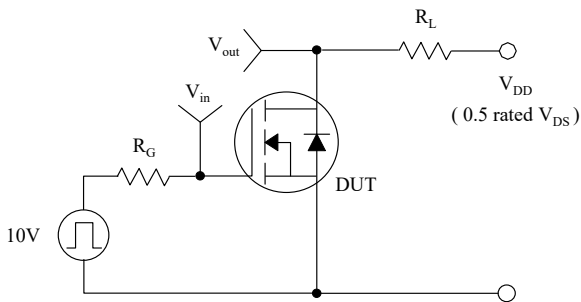

Figure 11-2. Transient Thermal Response Curve for SLF32N20C

Gate Charge Test Circuit & Waveform



Resistive Switching Test Circuit & Waveforms



Unclamped Inductive Switching Test Circuit & Waveforms

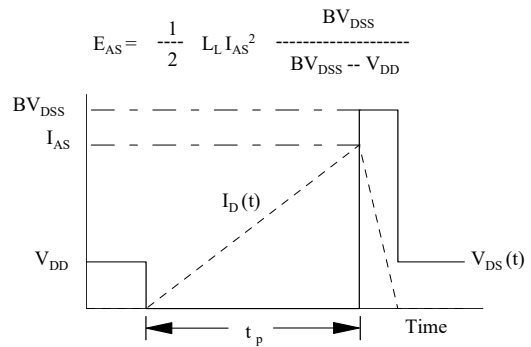
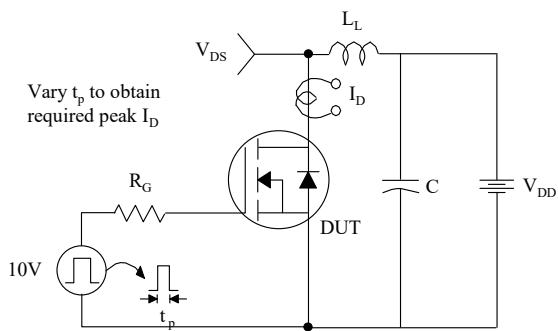

Peak Diode Recovery dv/dt Test Circuit & Waveforms

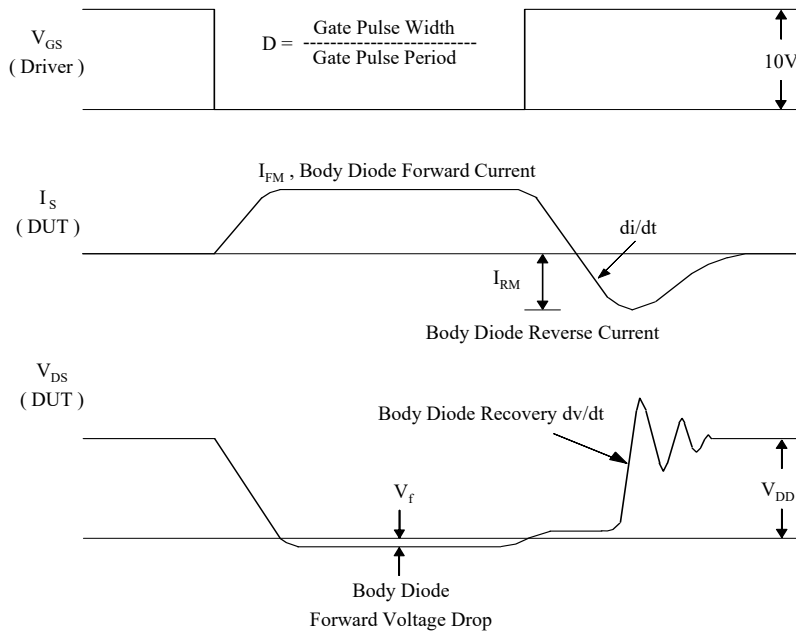
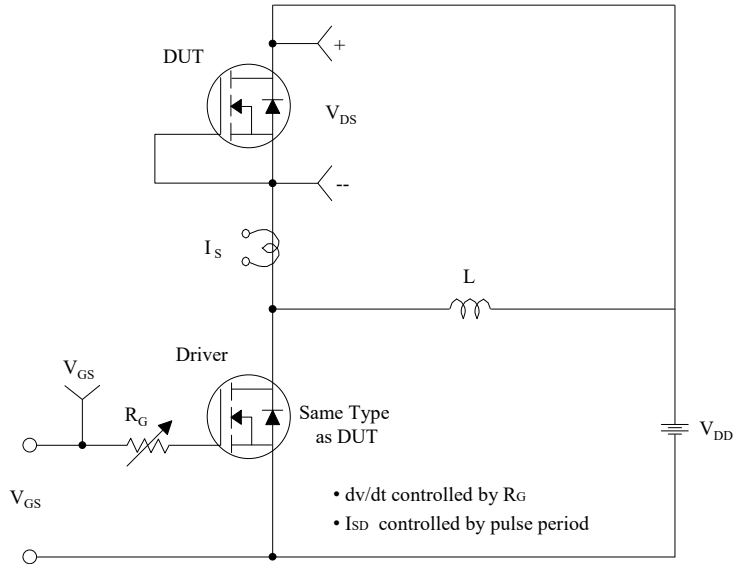

单击下面可查看定价，库存，交付和生命周期等信息

[>>Maplesemi\(美浦森半导体\)](#)