

SLN80N03T

30V N -Channel MOSFET

General Description

This Power MOSFET is produced using Msemitek's advanced TRENCH technology. This advanced technology has been especially tailored to minimize conduction loss, provide superior switching performance, and withstand high energy pulse in the avalanche and commutation mode.

Application

- PWM Application
- Load Switch
- Power Management

Features

- N-Channel: 30V 80A
 - $R_{DS(on)Typ} = 4.5m\Omega @ V_{GS} = 10V$
 - $R_{DS(on)Typ} = 6.8m\Omega @ V_{GS} = 4.5V$
- Very Low On-resistance $R_{DS(on)}$
- Low C_{rss}
- Fast switching
- 100% avalanche tested
- Improved dv/dt capability

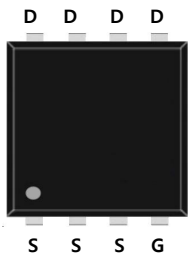

DFN3*3

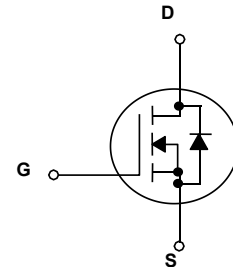
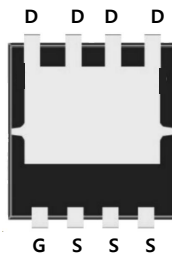

Absolute Maximum Ratings

 $T_C = 25^\circ\text{C}$ unless otherwise noted

Symbol	Parameter	SLN80N03T	Units
V_{DSS}	Drain-Source Voltage	30	V
I_D	Drain Current - Continuous ($T_C = 25^\circ\text{C}$) - Continuous ($T_C = 100^\circ\text{C}$)	80	A
		45	A
I_{DM}	Drain Current - Pulsed (Note 1)	320	A
V_{GSS}	Gate-Source Voltage	± 20	V
E_{AS}	Single Pulsed Avalanche Energy	306	mJ
P_D	Power Dissipation ($T_C = 25^\circ\text{C}$)	70	W
$R_{\theta JC}$	Thermal Resistance, Junction to Case	1.8	W/ $^\circ\text{C}$
T_J, T_{STG}	Operating and Storage Temperature Range	-55 to +150	$^\circ\text{C}$
T_L	Maximum lead temperature for soldering purposes, 1/8" from case for 5 seconds	300	$^\circ\text{C}$

* Drain current limited by maximum junction temperature.

Package Marking

Part Number	Top Marking	Package	Packing Method	MOQ	QTY
SLN80N03T	SLN80N03T	DFN3*3	Tape & Reel	5000	30000

Electrical Characteristics

 $T_C = 25^\circ\text{C}$ unless otherwise noted

Symbol	Parameter	Test Conditions	Min	Typ	Max	Units
--------	-----------	-----------------	-----	-----	-----	-------

Off Characteristics

BV_{DSS}	Drain-Source Breakdown Voltage	$V_{GS} = 0\text{ V}, I_D = 250\ \mu\text{A}$	30	--	--	V
I_{DSS}	Zero Gate Voltage Drain Current	$V_{DS} = 30\text{ V}, V_{GS} = 0\text{ V}$	--	--	1	μA
I_{GSSF}	Gate-Body Leakage Current, Forward	$V_{GS} = 20\text{ V}, V_{DS} = 0\text{ V}$	--	--	100	nA
I_{GSSR}	Gate-Body Leakage Current, Reverse	$V_{GS} = -20\text{ V}, V_{DS} = 0\text{ V}$	--	--	-100	nA

On Characteristics

$V_{GS(th)}$	Gate Threshold Voltage	$V_{DS} = V_{GS}, I_D = 250\ \mu\text{A}$	1.0	1.6	2.2	V
$R_{DS(on)}$	Static Drain-Source On-Resistance	$V_{GS} = 10\text{ V}, I_D = 30\text{ A}$	--	4.5	4.9	$\text{m}\Omega$
		$V_{GS} = 4.5\text{ V}, I_D = 20\text{ A}$	-	6.8	7.9	

Dynamic Characteristics

C_{iss}	Input Capacitance	$V_{DS} = 15\text{ V}, V_{GS} = 0\text{ V},$ $f = 1.0\text{ MHz}$	--	1970	-	pF
C_{oss}	Output Capacitance		--	215	-	pF
C_{rss}	Reverse Transfer Capacitance		--	178	-	pF

Switching Characteristics

$t_{d(on)}$	Turn-On Delay Time	$V_{GS} = 10\text{ V}, V_{DS} = 15\text{ V},$ $R_G = 2.7\ \Omega, I_D = 30\text{ A}$ (Note 3)	--	20	--	ns
t_r	Turn-On Rise Time		--	15	--	ns
$t_{d(off)}$	Turn-Off Delay Time		--	60	--	ns
t_f	Turn-Off Fall Time	$V_{DS} = 15\text{ V}, I_D = 30\text{ A},$ $V_{GS} = 10\text{ V}$ (Note 3)	--	10	--	ns
Q_g	Total Gate Charge		--	37.3	--	nC
Q_{gs}	Gate-Source Charge		--	5.8	--	nC
Q_{gd}	Gate-Drain Charge		--	7.7	--	nC

Drain-Source Diode Characteristics and Maximum Ratings

I_S	Maximum Continuous Drain-Source Diode Forward Current	--	--	80	A
I_{SM}	Maximum Pulsed Drain-Source Diode Forward Current	--	--	320	A
V_{SD}	Drain to Source Diode Forward Voltage, $V_{GS} = 0\text{ V}, I_{SD} = 30\text{ A}, T_J = 25^\circ\text{C}$	--	--	1.2	V
t_{rr}	Reverse Recovery Time & $T_J = 25^\circ\text{C}, I_F = 80\text{ A}, di/dt = 100\text{ A}/\mu\text{s}$	--	32	--	nS
Q_{rr}	Reverse Recovery Charge & $T_J = 25^\circ\text{C}, I_F = 80\text{ A}, di/dt = 100\text{ A}/\mu\text{s}$	--	12	--	nC

Notes:

1. Repetitive Rating: Pulse Width Limited by Maximum Junction Temperature
2. EAS condition: $T_J = 25^\circ\text{C}, V_{DD} = 15\text{ V}, V_G = 10\text{ V}, R_G = 25\ \Omega, L = 0.5\text{ mH}$,
3. Pulse Test: Pulse Width $\leq 300\ \mu\text{s}$, Duty Cycle $\leq 0.5\%$

N- Channel Typical Characteristics

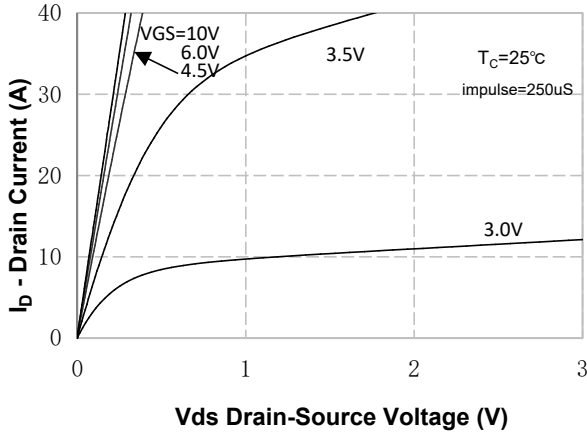

Figure 1. On-Region Characteristics

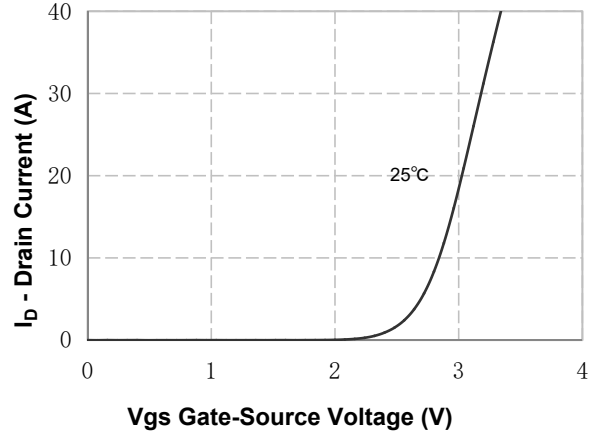

Figure 2. Transfer Characteristics

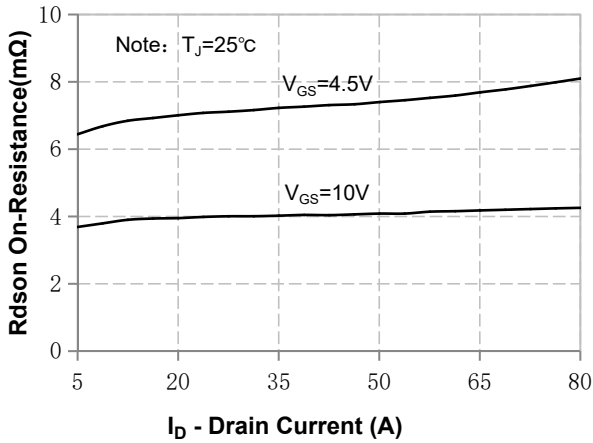

Figure 3. On-Resistance Variation vs Drain Current and Gate Voltage

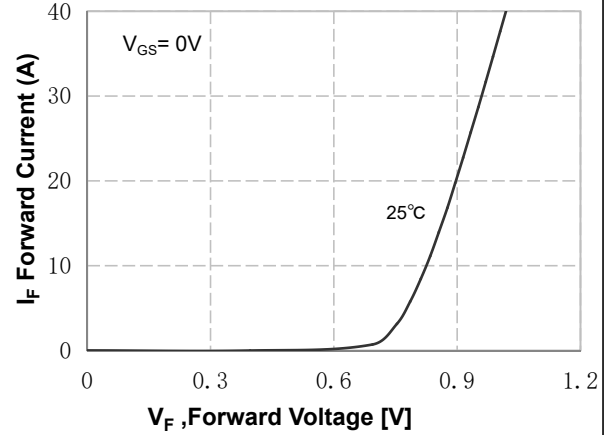

Figure 4. Body Diode Forward Voltage Variation vs Source Current

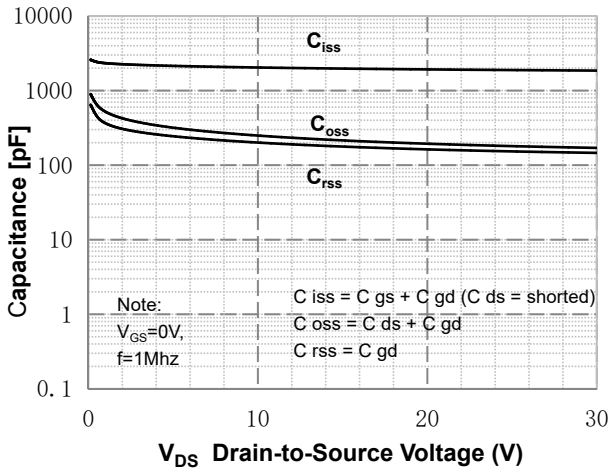

Figure 5. Capacitance Characteristics

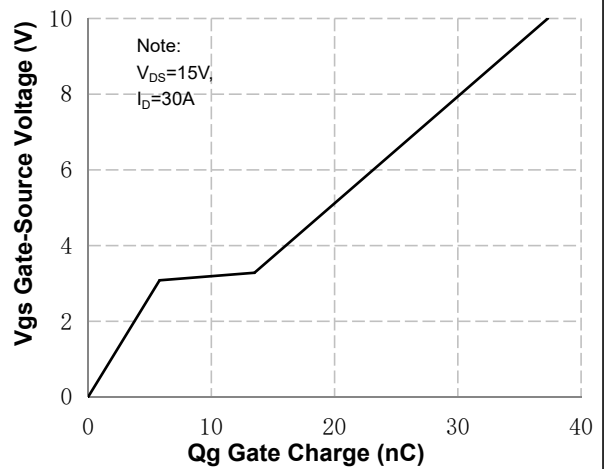

Figure 6. Gate Charge Characteristics

N- Channel Typical Characteristics (Continued)

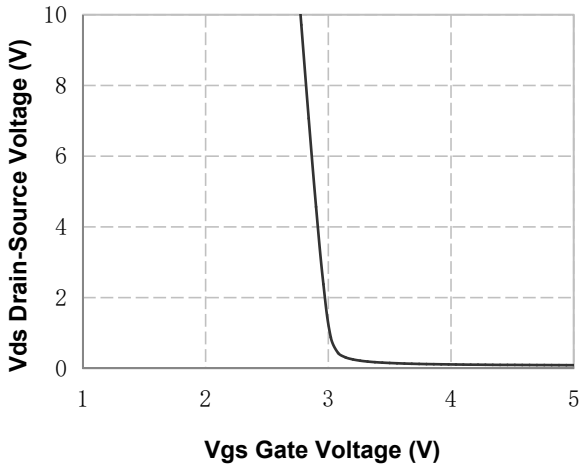

Figure 7. Vds Drain-Source Voltage vs Gate Voltage

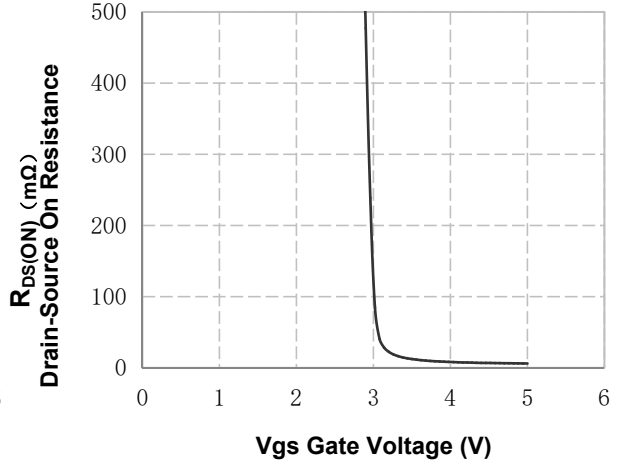

Figure 8. On-Resistance vs Gate Voltage

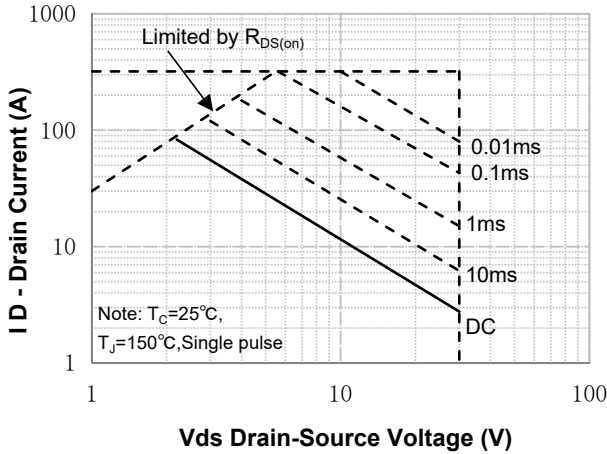

Figure 9. Maximum Safe Operating Area

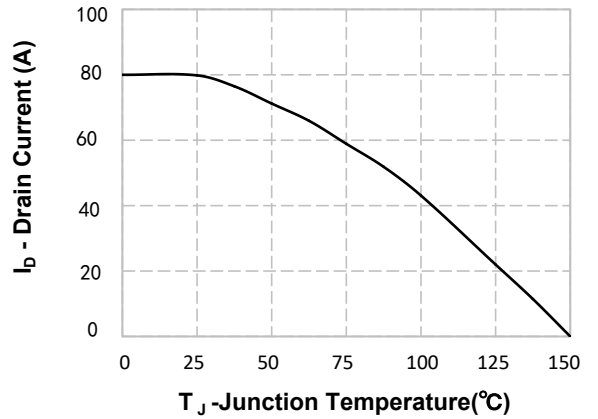

Figure 10. Maximum Continuous Drain Current vs Temperature

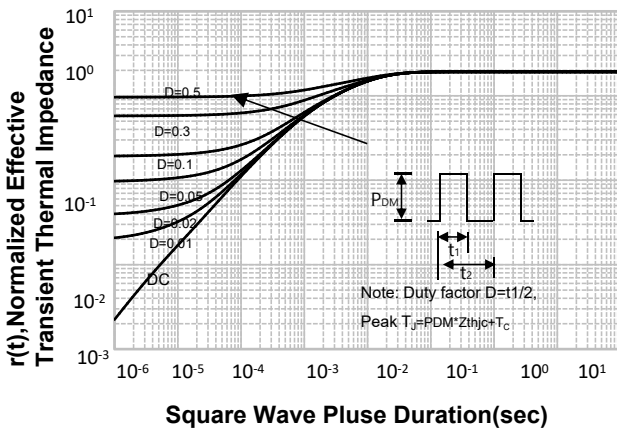
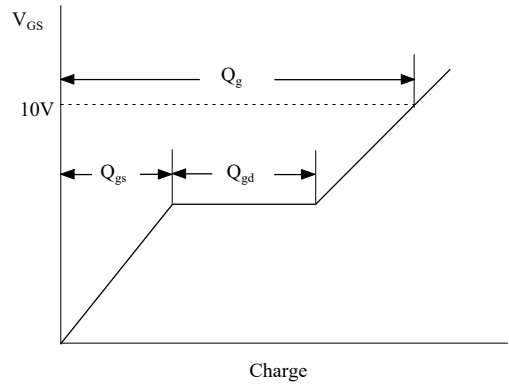
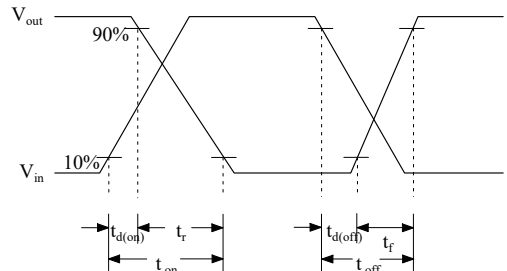
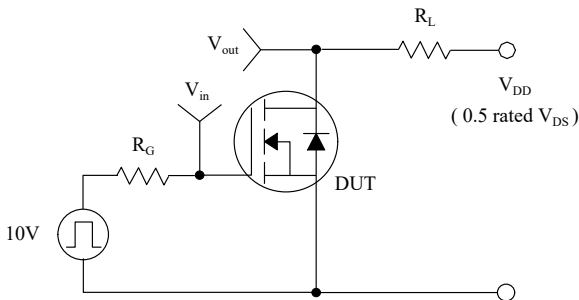

Figure 11. Transient Thermal Response Curve

Gate Charge Test Circuit & Waveform



Resistive Switching Test Circuit & Waveforms



Unclamped Inductive Switching Test Circuit & Waveforms

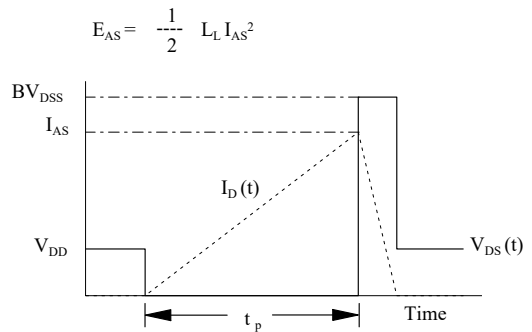

Peak Diode Recovery dv/dt Test Circuit & Waveforms

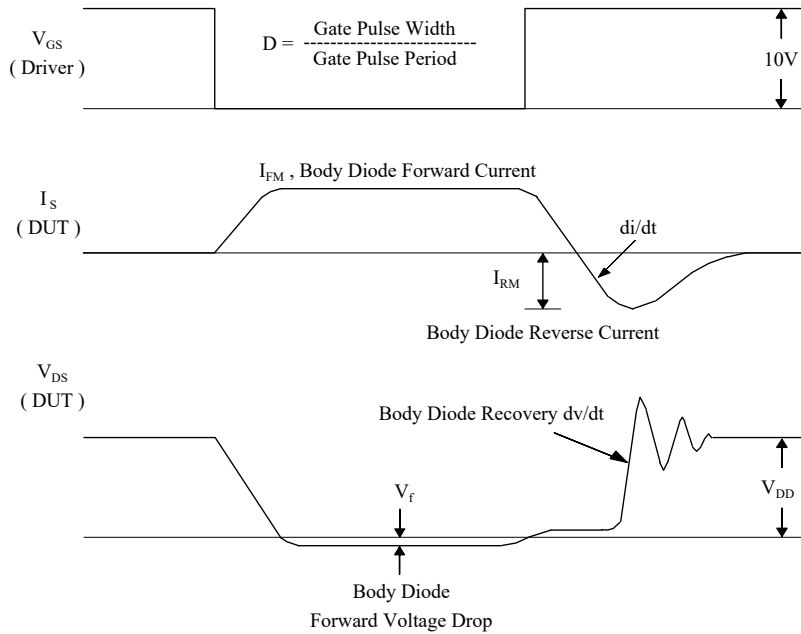

DFN 3*3 OUTLINE

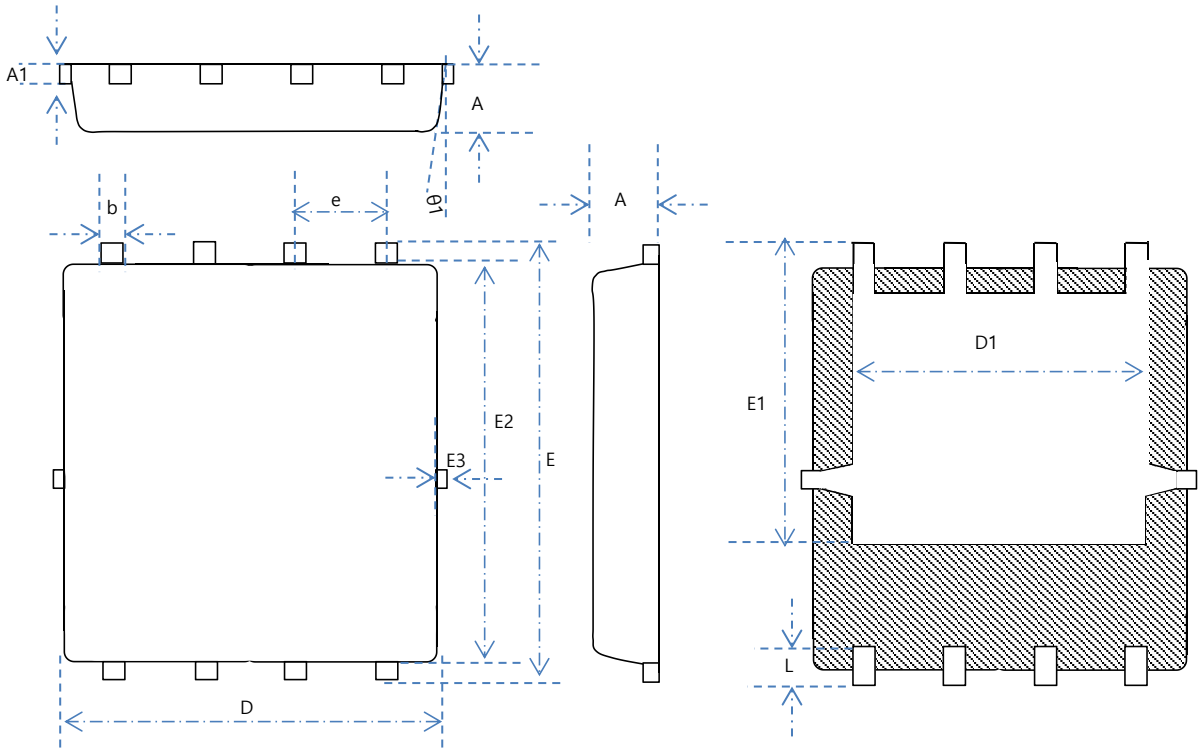

SYMBOL	Mechanical Dimensions/mm			SYMBOL	Mechanical Dimensions/mm		
	MIN	NOM	MAX		MIN	NOM	MAX
A	0.725	0.775	0.825	D	3.05	3.15	3.25
A1	0.152 REF			e	0.65 TYPE		
b	0.27	0.32	0.37	D1	2.25	2.45	2.65
E	3.25	3.35	3.45	L	0.28	0.38	0.48
E1	1.63	1.73	1.83				
E2	3.0	3.1	3.2	$\theta 1$	8°	10°	12°
E3	-	-	0.10				

NAME	DFN 3*3 OUTLINE	UNIT	mm	DESIGNED	Shawn	THIRD ANGLE SYSTEM
DWGNO		PAGE	1 OF 1	CHECKED		
VERSION	Ver1.0	ISSUE DATE		APPROVED		

Disclaimer

The content specified herein is for the purpose of introducing Msemitek's products (here in after "Products"). The information given in this document shall in no event be regarded as a guarantee of conditions or characteristics. Examples of application circuits, circuit constants and any other information contained herein illustrate the standard usage and operations of the Products. The peripheral conditions must be taken into account when designing circuits for mass production.

Msemitek does not assume any liability for infringement of patents, copyrights, or other intellectual property rights of third parties by or arising from the use of the Products or technical information described in this document.

The products are not designed or manufactured to be used with any equipment, device or system which requires an extremely high level of reliability the failure or malfunction of which may result in a direct threat to human life or create a risk of human injury (such as a medical instrument, transportation equipment, aerospace machinery, nuclear-reactor controller, fuel-controller or other safety device). Msemitek shall bear no responsibility in any way for use of any of the Products for the above special purposes.

Although, Msemitek endeavors to improve the quality and reliability of its products, semiconductor products have specific characteristics such as the occurrence of failure at a certain rate and malfunctions under certain use conditions. Please be sure to implement safety measures to guard them against the possibility of physical injury, and injury or damage caused by fire in the event of the failure of a Msemitek's product.

The content specified herein is subject to change for improvement without notice. When using a Msemitek's product, be sure to obtain the latest specifications.

单击下面可查看定价，库存，交付和生命周期等信息

[>>Maplesemi\(美浦森半导体\)](#)