

GPS+GSM+WIFI 厚贴片组合天线

AN_GPS_GSM_WF_056 Adhesive

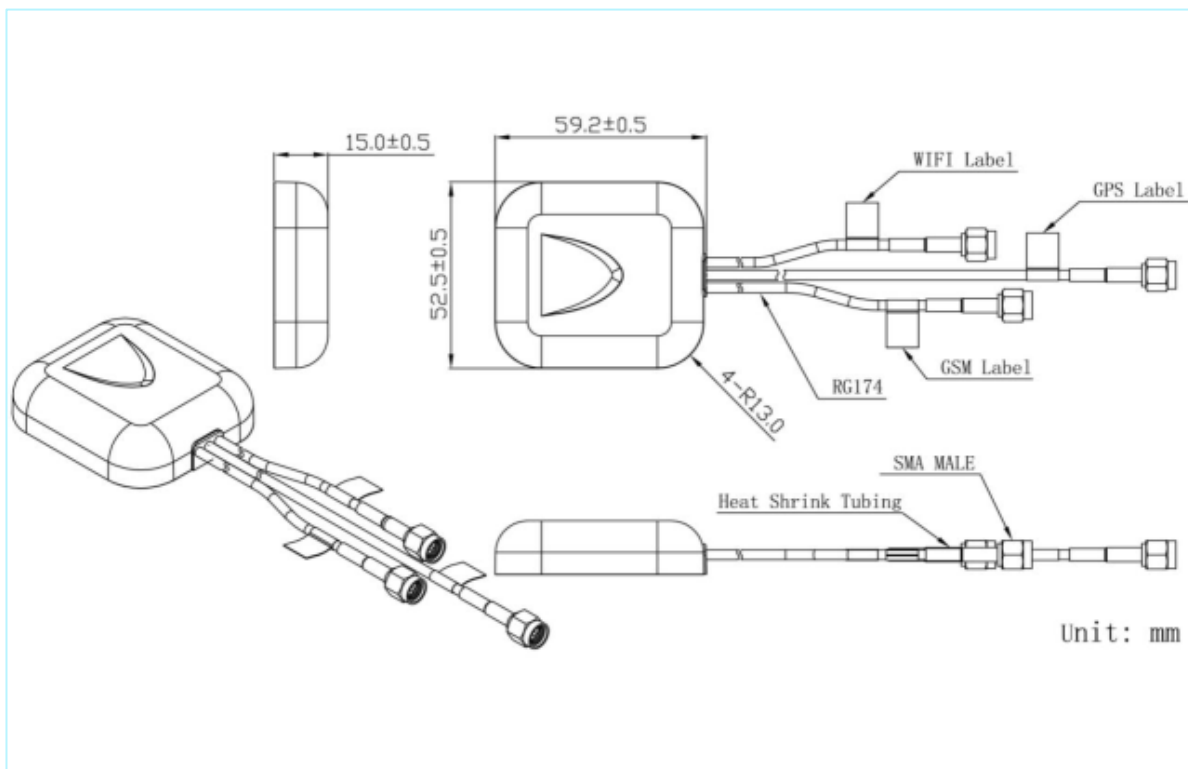

机械尺寸



GPS+GSM+WIFI 厚贴片组合天线

规格

项目		规格	
GPS天线	电介质天线	中心频率	1575.42±3MHz
		带宽	CF±5MHz
		极化	右旋圆极化
		增益	2dBic (最高值)
		V.S.W.R	<1.5
		阻抗	50Ω
		轴比	3dB (最大值)
	低噪声放大器	增益	28±2dB
		噪声因数	<1.5
		前频段衰减	12dB@CF+50MHz/16dB@CF-50MHz
		V.S.W.R	<2.0
		电源电压	2.2~5V直流
	电流消耗	<15mA	
GSM天线	频率范围	824~960MHz/1710~2170MHz	
	V.S.W.R	<2.0 (最小值)	
	极化	线性	
	增益	2.0dBi	
	阻抗	50Ω	
WIFI天线	频率范围	2400~2483.5MHz	
	带宽	83.5MHz	
	极化	线性	
	增益	3dBi	
	V.S.W.R	<2.0 (最小值)	
	阻抗	50Ω	
机械	电缆	RG174 5m (可定制)	
	连接器	GPS+GSM:SMA male WiFi:RP-SMA plug (可定制)	
	材料	ABS	
	安装方法	粘贴	



GPS+GSM+WIFI 厚贴片组合天线

规格

环境	工作温度	-40°C~+85°C
	相对湿度	高达95%
	入口保护	IP65~IP66 (不含电缆插座)
	振动	10至55Hz, 1.5mm振幅, 2小时
	环保	符合ROHS标准

GPS+GSM+WIFI 厚贴片组合天线

辐射方向图

GPS部分方向图

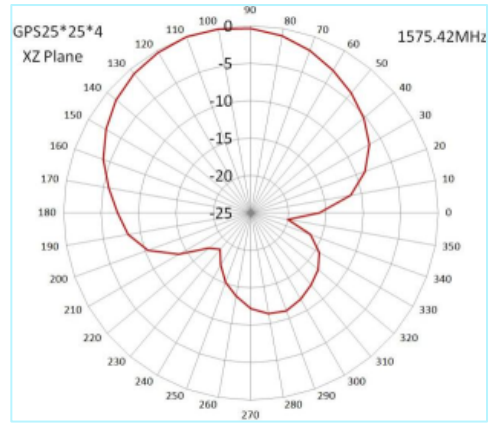
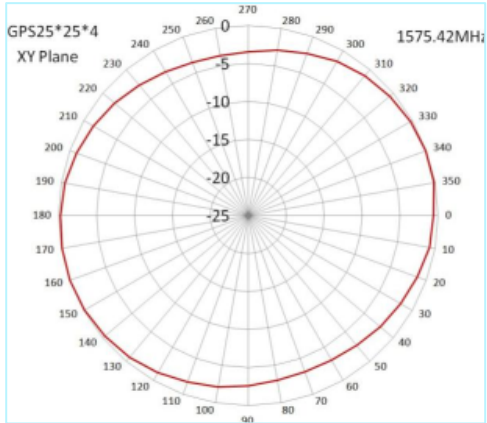

GSM部分方向图

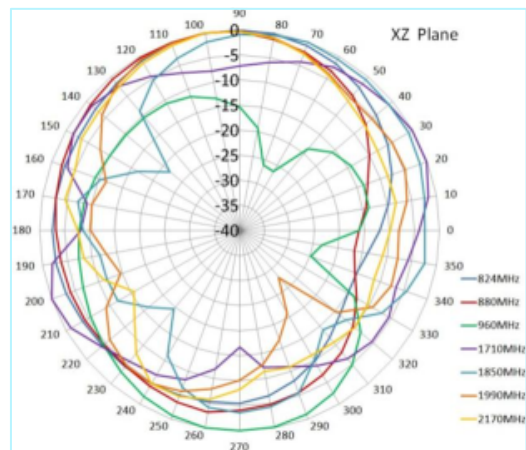
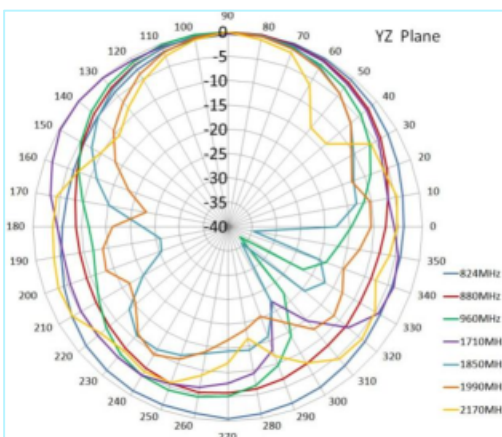
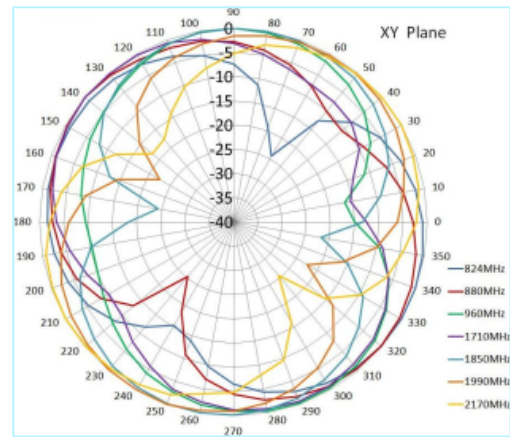
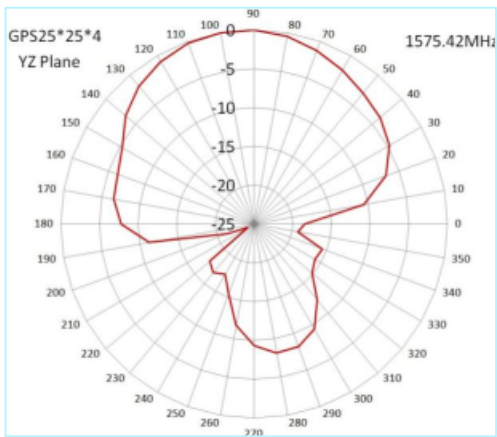

GPS+GSM+WIFI 厚贴片组合天线

辐射方向图

WIFI部分方向图

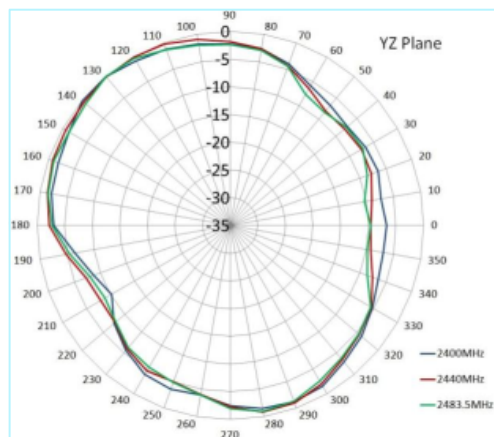
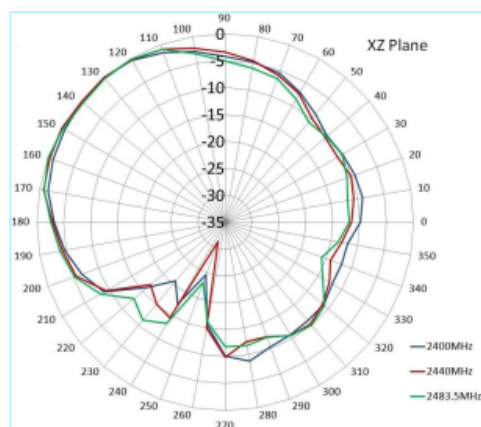
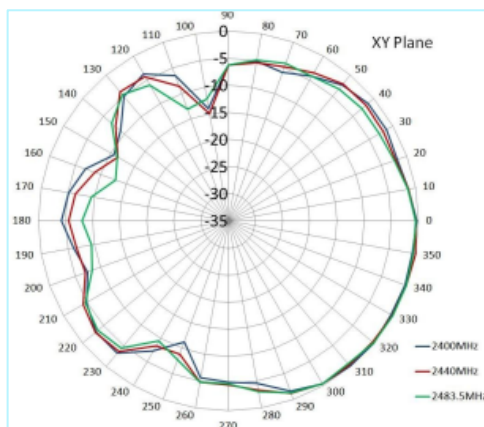

单击下面可查看定价，库存，交付和生命周期等信息

[>>Maswell\(迈斯维\)](#)