

	E480232
---	----------------

Features

- AEC-Q101 Qualified
- For Surface Mount Application in Order to Optimize Board Space
- Built-in Strain Relief
- Glass Passivated Junction
- Plastic Package Has Underwrites Laboratory Flammability
- Typical I_D less Than $1\mu A$ Above 10V
- High Temperature Soldering: 260°C/10 Seconds at Terminals
- Halogen Free. "Green" Device (Note 1)
- Moisture Sensitivity Level 1
- Epoxy Meets UL 94 V-0 Flammability Rating
- Lead Free Finish/RoHS Compliant (Note2) ("P" Suffix Designates RoHS Compliant. See Ordering Information)
- For Bidirectional Devices Add "C" To The Suffix of The Part Number: i.e.SMCJ10CAHE3 for 5% Tolerance

Mechanical Data

- Polarity: Color Band Denotes Positive End(Cathode) Except Bi-directional Types
- Weight: 0.007 ounce, 0.21 gram
- Manufacturing Code Added for Better Tracking
- Standard Packaging: 16mm Tape Per (EIA 481)
- Terminals: Solderable Per MIL-STD-750, Method 2026

Maximum Ratings

- Operating Junction Temperature Range: -55°C to +175°C
- Storage Temperature Range: -55°C to +175°C

Electrical Characteristics @ 25°C Unless Otherwise Specified

Peak Pulse Power Surge Current on 10/1000 μs Waveform	I_{PPM}	See the Table	Note 3, Fig4
Peak Pulse Power Dissipation on 10/1000 μs Waveform	P_{PPM}	1500W(Min)	Note 3,4, Fig1

Notes:

1. Halogen free "Green" products are defined as those which contain <900ppm bromine, <900ppm chlorine (<1500ppm total Br + Cl) and <1000ppm antimony compounds.
2. High Temperature Solder Exemption Applied, see EU Directive Annex 7a.
3. Non-repetitive current pulse, per Fig.3 and derated above $T_A=25^\circ C$ per Fig.4.
4. Mounted on 8.0mm² copper pads to each terminal.

Pin Configuration:

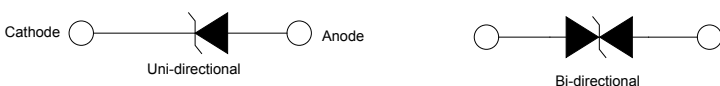

1500 Watt TVS
10 to 190 Volts

SMC (DO-214AB) (LEAD FRAME)

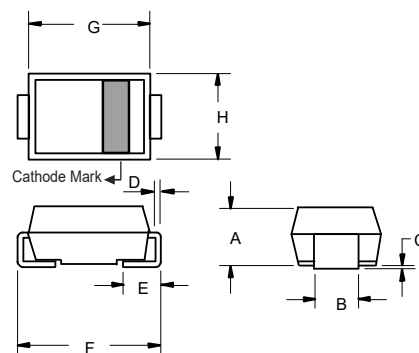

DIM	DIMENSIONS				NOTE
	INCHES		MM		
	MIN	MAX	MIN	MAX	
A	0.079	0.103	2.00	2.62	
B	0.108	0.128	2.75	3.25	
C	0.002	0.008	0.051	0.203	
D	0.006	0.012	0.152	0.305	
E	0.030	0.060	0.76	1.52	
F	0.305	0.320	7.75	8.13	
G	0.260	0.280	6.60	7.11	
H	0.220	0.245	5.59	6.22	

Suggested Solder Pad Layout

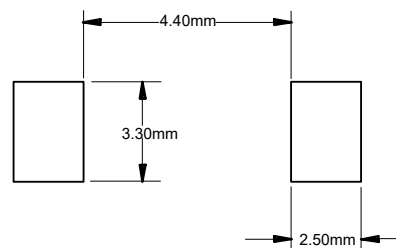

Electrical Characteristics @ 25°C Unless Otherwise Specified

MCC Part Number		Reverse Stand-Off Voltage	Breakdown Voltage $V_{BR}(V)$		Test Current	Max. Clamping Voltage @ I_{PP}	Peak Pulse Current	Reverse Leakage Current @ V_{WM}	Marking Code	
Uni-Polar	Bi-Polar	$V_{WM}(V)$	Min	Max	$I_T(mA)$	$V_C(V)$	$I_{PP}(A)$	$I_D(\mu A)$	UNI	BI
SMCJ10AHE3	SMCJ10CAHE3	10	11.1	12.3	1	17.0	88.3	5	GDX	BDX
SMCJ11AHE3	SMCJ11CAHE3	11	12.2	13.5	1	18.2	82.5	1	GDZ	BDZ
SMCJ12AHE3	SMCJ12CAHE3	12	13.3	14.7	1	19.9	75.4	1	GEE	BEE
SMCJ13AHE3	SMCJ13CAHE3	13	14.4	15.9	1	21.5	69.8	1	GEG	BEG
SMCJ14AHE3	SMCJ14CAHE3	14	15.6	17.2	1	23.2	64.7	1	GEK	BEK
SMCJ15AHE3	SMCJ15CAHE3	15	16.7	18.5	1	24.4	61.5	1	GEM	BEM
SMCJ16AHE3	SMCJ16CAHE3	16	17.8	19.7	1	26.0	57.7	1	GEP	BEP
SMCJ17AHE3	SMCJ17CAHE3	17	18.9	20.9	1	27.6	54.4	1	GER	BER
SMCJ18AHE3	SMCJ18CAHE3	18	20.0	22.1	1	29.2	51.4	1	GET	BET
SMCJ20AHE3	SMCJ20CAHE3	20	22.2	24.5	1	32.4	46.3	1	GEV	BEV
SMCJ22AHE3	SMCJ22CAHE3	22	24.4	26.9	1	35.5	42.3	1	GEX	BEX
SMCJ24AHE3	SMCJ24CAHE3	24	26.7	29.5	1	38.9	38.6	1	GEZ	BEZ
SMCJ26AHE3	SMCJ26CAHE3	26	28.9	31.9	1	42.1	35.7	1	GFE	BFE
SMCJ28AHE3	SMCJ28CAHE3	28	31.1	34.4	1	45.4	33.1	1	GFG	BFG
SMCJ30AHE3	SMCJ30CAHE3	30	33.3	36.8	1	48.4	31.0	1	GFK	BFK
SMCJ33AHE3	SMCJ33CAHE3	33	36.7	40.6	1	53.3	28.2	1	GFM	BFM
SMCJ36AHE3	SMCJ36CAHE3	36	40.0	44.2	1	58.1	25.9	1	GFP	BFP
SMCJ40AHE3	SMCJ40CAHE3	40	44.4	49.1	1	64.5	23.3	1	GFR	BFR
SMCJ43AHE3	SMCJ43CAHE3	43	47.8	52.8	1	69.4	21.7	1	GFT	BFT
SMCJ45AHE3	SMCJ45CAHE3	45	50.0	55.3	1	72.7	20.6	1	GFV	BFV
SMCJ48AHE3	SMCJ48CAHE3	48	53.3	58.9	1	77.4	19.4	1	GFY	BFY
SMCJ51AHE3	SMCJ51CAHE3	51	56.7	62.7	1	82.4	18.2	1	GFZ	BFZ
SMCJ54AHE3	SMCJ54CAHE3	54	60.0	66.3	1	87.1	17.3	1	GGE	BGE
SMCJ58AHE3	SMCJ58CAHE3	58	64.4	71.2	1	93.6	16.1	1	GGG	BGG
SMCJ60AHE3	SMCJ60CAHE3	60	66.7	73.7	1	96.8	15.5	1	GGK	BGK
SMCJ64AHE3	SMCJ64CAHE3	64	71.1	78.6	1	103.0	14.6	1	GGM	BGM
SMCJ70AHE3	SMCJ70CAHE3	70	77.8	86.0	1	113.0	13.3	1	GGP	BGP
SMCJ75AHE3	SMCJ75CAHE3	75	83.3	92.1	1	121.0	12.4	1	GGR	BGR
SMCJ78AHE3	SMCJ78CAHE3	78	86.7	95.8	1	126.0	11.9	1	GGT	BGT
SMCJ80AHE3	SMCJ80CAHE3	80	88.8	97.6	1	129.6	11.6	1	GGU	BGU
SMCJ85AHE3	SMCJ85CAHE3	85	94.4	104.0	1	137.0	11.0	1	GGV	BGV
SMCJ90AHE3	SMCJ90CAHE3	90	100.0	111.0	1	146.0	10.3	1	GGX	BGX
SMCJ100AHE3	SMCJ100CAHE3	100	111.0	123.0	1	162.0	9.3	1	GGZ	BGZ
SMCJ110AHE3	SMCJ110CAHE3	110	122.0	135.0	1	177.0	8.5	1	GHE	BHE
SMCJ120AHE3	SMCJ120CAHE3	120	133.0	147.0	1	193.0	7.8	1	GHG	BHG
SMCJ130AHE3	SMCJ130CAHE3	130	144.0	159.0	1	209.0	7.2	1	GHK	BHK
SMCJ150AHE3	SMCJ150CAHE3	150	167.0	185.0	1	243.0	6.2	1	GHM	BHM
SMCJ160AHE3	SMCJ160CAHE3	160	178.0	197.0	1	259.0	5.8	1	GHP	BHP
SMCJ170AHE3	SMCJ170CAHE3	170	189.0	209.0	1	275.0	5.5	1	GHR	BHR
SMCJ180AHE3	SMCJ180CAHE3	180	200.0	220.0	1	292.0	5.1	1	GHT	BHT
SMCJ190AHE3	SMCJ190CAHE3	190	211.0	232.0	1	307.8	4.9	1	GHX	BHX

For bi-directional type having V_{WM} of 10volts and less, the I_R limit is double. For parts without A, the V_{BR} is $\pm 10\%$

Curve Characteristics

Fig. 1 - Peak Pulse Power Rating Curve

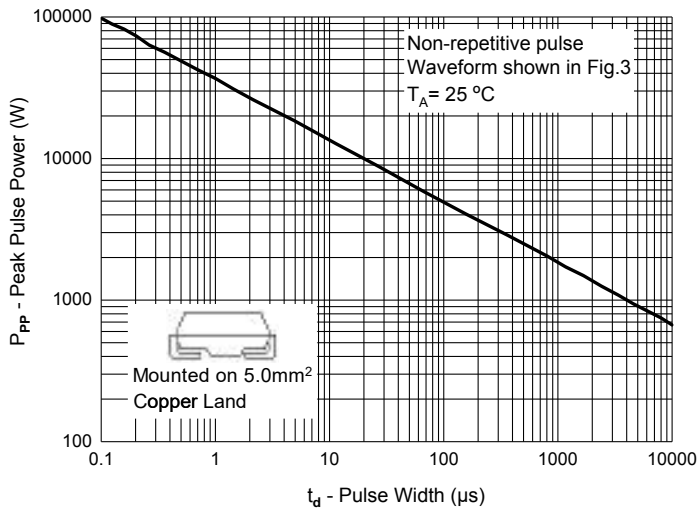

Fig. 2 - Typical Junction Capacitance

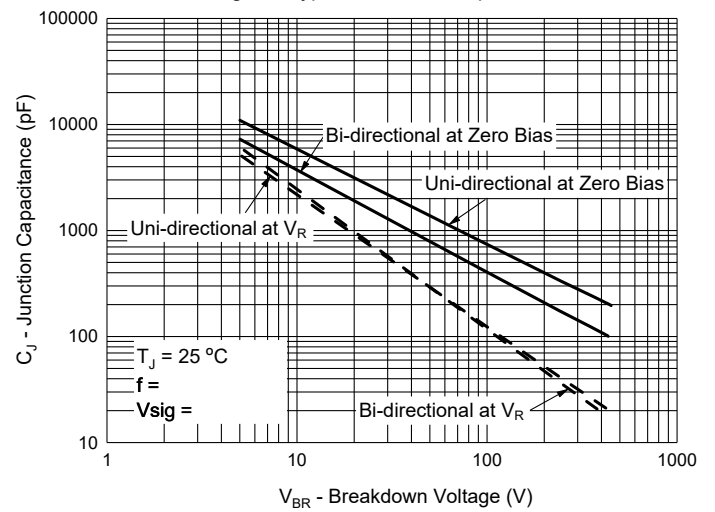

Fig. 3 - Pulse Waveform

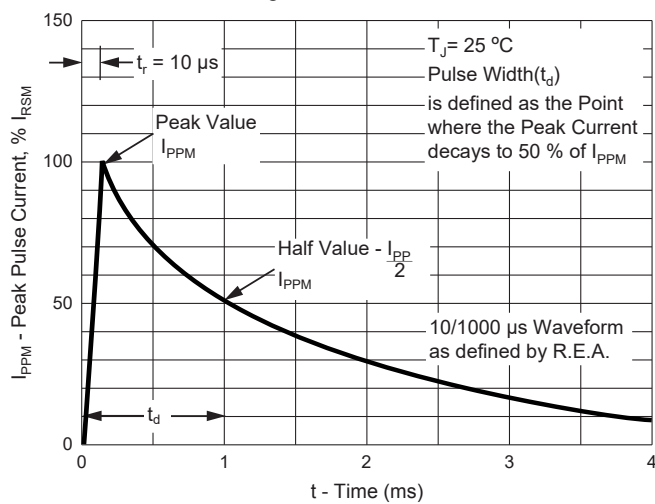
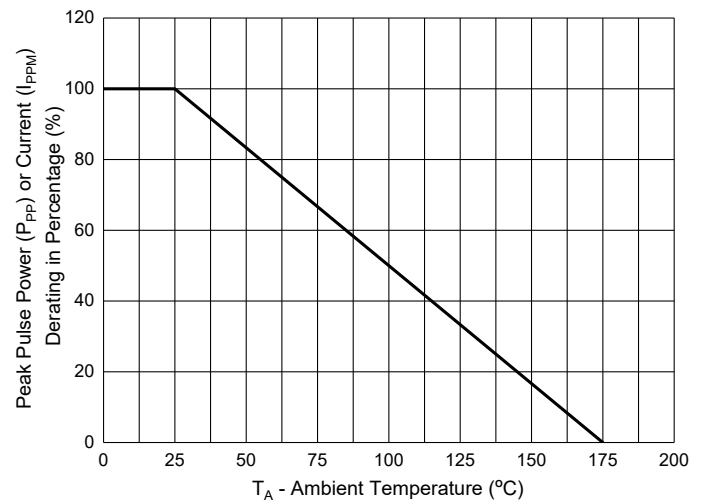

Fig. 4 - Pulse Derating Curve



Ordering Information

Device	Packing
Part Number-TP	Tape&Reel:3Kpcs/Reel

IMPORTANT NOTICE

Micro Commercial Components Corp. reserves the right to make changes without further notice to any product herein to make corrections, modifications, enhancements, improvements, or other changes. *Micro Commercial Components Corp.* does not assume any liability arising out of the application or use of any product described herein; neither does it convey any license under its patent rights, nor the rights of others. The user of products in such applications shall assume all risks of such use and will agree to hold *Micro Commercial Components Corp.* and all the companies whose products are represented on our website, harmless against all damages. *Micro Commercial Components Corp.* products are sold subject to the general terms and conditions of commercial sale, as published at <https://www.mccsemi.com/Home/TermsAndConditions>.

LIFE SUPPORT

MCC's products are not authorized for use as critical components in life support devices or systems without the express written approval of Micro Commercial Components Corporation.

CUSTOMER AWARENESS

Counterfeiting of semiconductor parts is a growing problem in the industry. Micro Commercial Components (MCC) is taking strong measures to protect ourselves and our customers from the proliferation of counterfeit parts. MCC strongly encourages customers to purchase MCC parts either directly from MCC or from Authorized MCC Distributors who are listed by country on our web page cited below. Products customers buy either from MCC directly or from Authorized MCC Distributors are genuine parts, have full traceability, meet MCC's quality standards for handling and storage. **MCC will not provide any warranty coverage or other assistance for parts bought from Unauthorized Sources.** MCC is committed to combat this global problem and encourage our customers to do their part in stopping this practice by buying direct or from authorized distributors.

单击下面可查看定价，库存，交付和生命周期等信息

[>>MCC\(美微科\)](#)