

**Features**

- Low Operating Voltage
- Ultra Low Clamping Voltage
- Moisture Sensitivity Level 1
- Epoxy Meets UL 94 V-0 Flammability Rating
- Halogen Free. "Green" Device (Note 1)
- Lead Free Finish/RoHS Compliant ("P" Suffix Designates RoHS Compliant. See Ordering Information)

**Maximum Ratings**

- Operating Junction Temperature Range: -55°C to +125°C
- Storage Temperature Range: -55°C to +150°C

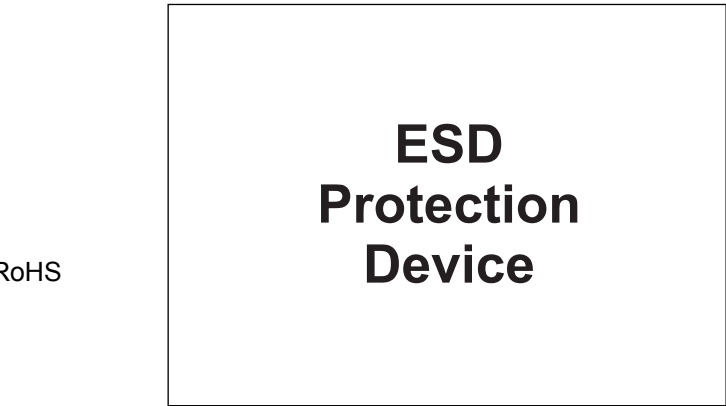

MCC Part Number	Device Marking
ESD7V0P4	73P

IEC61000-4-2(ESD)	Air Contact	±30KV ±30KV
IEC61000-4-4 (EFT) @5/50ns		80A
Peak Pulse Current(8/20µs)	I <sub>PP</sub>	275A
Peak Pulse Power (8/20µs)	P <sub>PK</sub>	6000W

Note: 1. Halogen free "Green" products are defined as those which contain <900ppm bromine, <900ppm chlorine (<1500ppm total Br + Cl) and <1000ppm antimony compounds.

**DFN2020-3L**

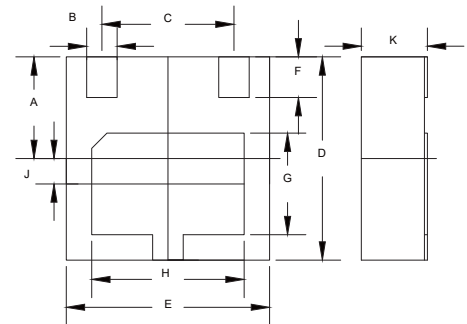

**Circuit and Pin Schematic**

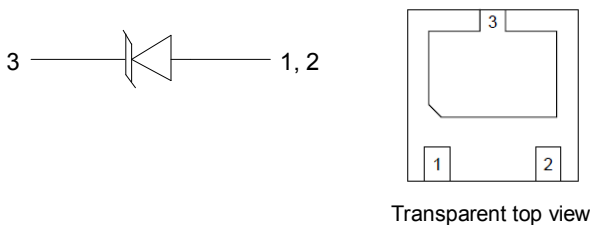

DIM	INCHES		MM		NOTE
	MIN	MAX	MIN	MAX	
A	0.037	0.041	0.950	1.050	
B	0.010	0.014	0.250	0.350	
C	0.051		1.30		TYP.
D	0.075	0.083	1.900	2.100	
E	0.075	0.083	1.900	2.100	
F	0.014	0.018	0.350	0.450	
G	0.035	0.043	0.900	1.100	
H	0.055	0.063	1.400	1.600	
J	0.008	0.012	0.200	0.300	
K	-	0.026	-	0.650	

**Electrical Characteristics @ 25°C (Unless Otherwise Specified)**

Parameter	Symbol	Conditions	Min.	Typ.	Max.	Units
Reverse Working Voltage	$V_{RWM}$				7.5	V
Reverse Breakdown Voltage	$V_{BR}$	$I_T = 1\text{mA}$	8			V
Reverse Leakage Current	$I_R$	$V_{RWM} = 7.5\text{V}$			1	$\mu\text{A}$
Clamping Voltage	$V_C$	$I_{PP} = 20\text{A}$ , $t_p = 8/20\mu\text{s}$			10	V
Clamping Voltage	$V_C$	$I_{PP} = 275\text{A}$ , $t_p = 8/20\mu\text{s}$			22	V
Junction Capacitance	$C_J$	$V_R = 0\text{V}$ , $f = 1\text{MHz}$			1500	pF

**Curve Characteristics**

Fig. 1 - 8 X 20µs Pulse Waveform

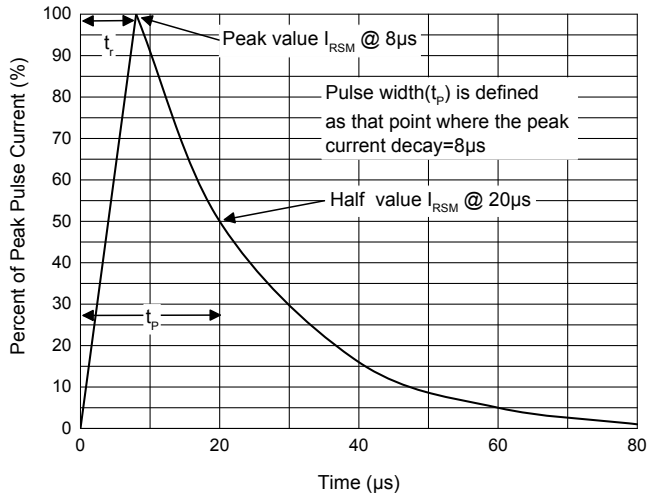

Fig. 2 - Pulse Derating Curve

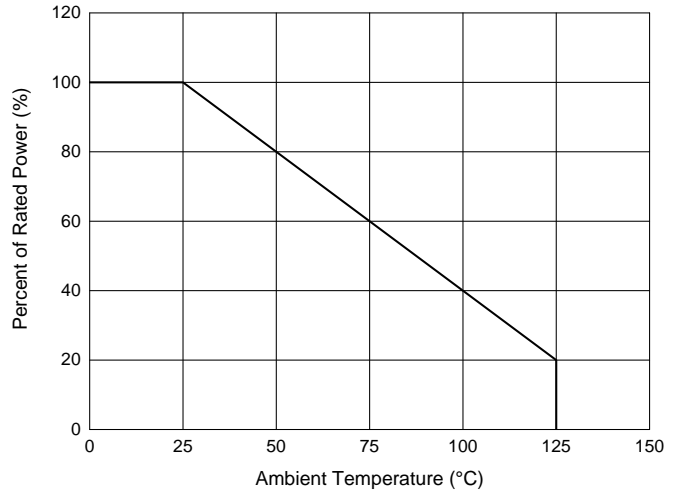

Fig. 3 - Non-Repetitive Peak Pulse Power

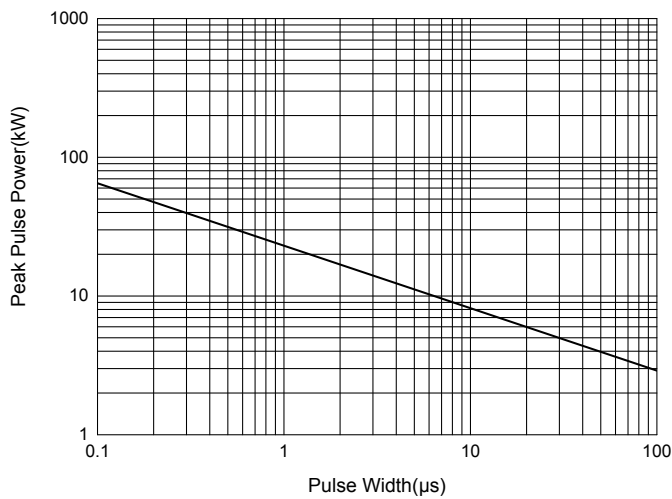

Fig. 4 - Clamping Voltage Characteristics

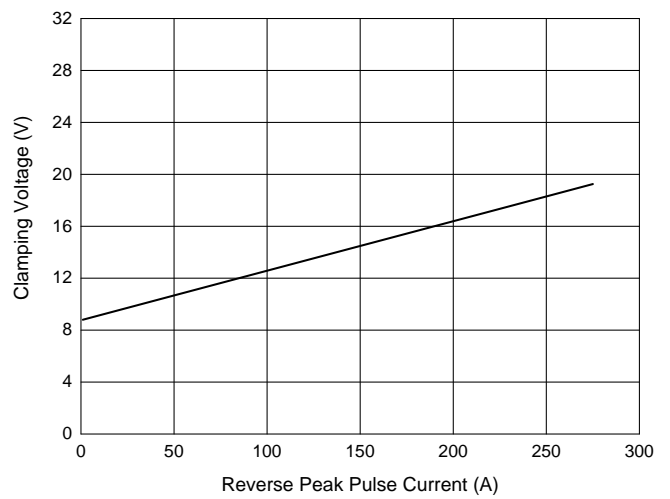
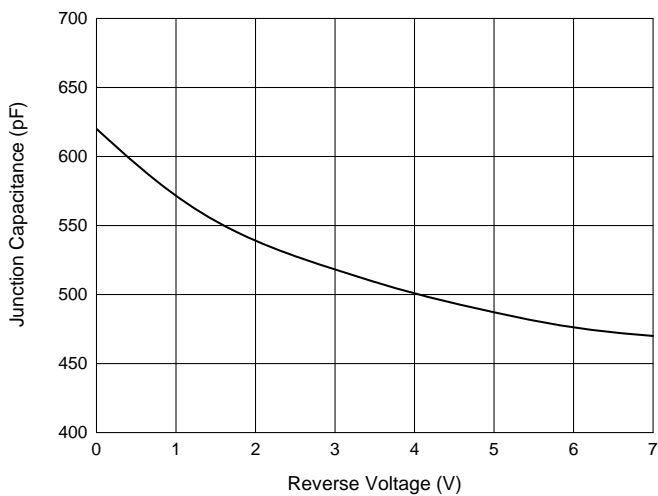

Fig. 5 - Capacitance Characteristics



## Ordering Information

Device	Packing
Part Number-TP	Tape&Reel: 3Kpcs/Reel

**\*\*\*IMPORTANT NOTICE\*\*\***

**Micro Commercial Components Corp.** reserves the right to make changes without further notice to any product herein to make corrections, modifications, enhancements, improvements, or other changes. **Micro Commercial Components Corp.** does not assume any liability arising out of the application or use of any product described herein; neither does it convey any license under its patent rights, nor the rights of others. The user of products in such applications shall assume all risks of such use and will agree to hold **Micro Commercial Components Corp.** and all the companies whose products are represented on our website, harmless against all damages. **Micro Commercial Components Corp.** products are sold subject to the general terms and conditions of commercial sale, as published at <https://www.mccsemi.com/Home/TermsAndConditions>.

**\*\*\*LIFE SUPPORT\*\*\***

MCC's products are not authorized for use as critical components in life support devices or systems without the express written approval of Micro Commercial Components Corporation.

**\*\*\*CUSTOMER AWARENESS\*\*\***

Counterfeiting of semiconductor parts is a growing problem in the industry. Micro Commercial Components (MCC) is taking strong measures to protect ourselves and our customers from the proliferation of counterfeit parts. MCC strongly encourages customers to purchase MCC parts either directly from MCC or from Authorized MCC Distributors who are listed by country on our web page cited below. Products customers buy either from MCC directly or from Authorized MCC Distributors are genuine parts, have full traceability, meet MCC's quality standards for handling and storage. **MCC will not provide any warranty coverage or other assistance for parts bought from Unauthorized Sources.** MCC is committed to combat this global problem and encourage our customers to do their part in stopping this practice by buying direct or from authorized distributors.

单击下面可查看定价，库存，交付和生命周期等信息

[>>MCC\(美微科\)](#)