

Features

- Built-In Bias Resistors Enable the Configuration of an Inverter Circuit Without Connecting External Input Resistors
- The Bias Resistors Consist of Thin-Film Resistors With Complete Isolation to Allow Negative Biasing of the Input. They Also Have the Advantage of Almost Completely Eliminating Parasitic Effects
- Only the On/Off Conditions Need to Be Set For Operation, Making Device Design Easy
- Halogen Free. "Green" Device (Note 1)
- Moisture Sensitivity Level 1
- Epoxy Meets UL 94 V-0 Flammability Rating
- Lead Free Finish/RoHS Compliant ("P" Suffix Designates RoHS Compliant. See Ordering Information)

Maximum Ratings @ 25°C Unless Otherwise Specified

| Parameter | Symbol | Min | Typ | Max | Unit |
|----------------------|--------------|-----|------|-----|------|
| Supply Voltage | V_{CC} | --- | -50 | --- | V |
| Input Voltage | V_{IN} | -40 | --- | 6 | V |
| Output Current | I_O | --- | -70 | --- | mA |
| | $I_{C(Max)}$ | --- | -100 | --- | mA |
| Power Dissipation | P_D | --- | 200 | --- | mW |
| Junction Temperature | T_J | --- | --- | 150 | °C |
| Storage Temperature | T_{stg} | -55 | --- | 150 | °C |

Note: 1. Halogen free "Green" products are defined as those which contain <900ppm bromine, <900ppm chlorine (<1500ppm total Br + Cl) and <1000ppm antimony compounds.

Device Marking: 54

Internal Structure

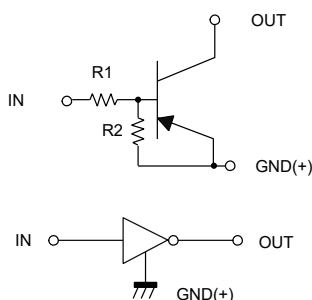

PNP Digital Transistor

SOT-23

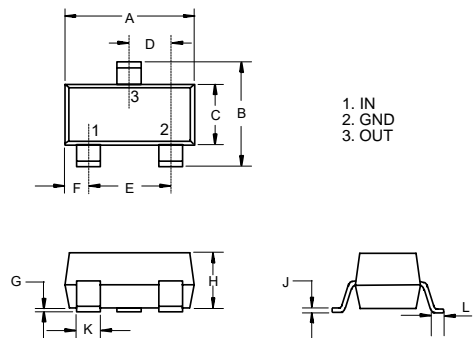

| DIM | INCHES | | MM | | NOTE |
|-----|--------|-------|------|------|------|
| | MIN | MAX | MIN | MAX | |
| A | 0.110 | 0.120 | 2.80 | 3.04 | |
| B | 0.083 | 0.104 | 2.10 | 2.64 | |
| C | 0.047 | 0.055 | 1.20 | 1.40 | |
| D | 0.034 | 0.041 | 0.85 | 1.05 | |
| E | 0.067 | 0.083 | 1.70 | 2.10 | |
| F | 0.018 | 0.024 | 0.45 | 0.60 | |
| G | 0.0004 | 0.006 | 0.01 | 0.15 | |
| H | 0.035 | 0.043 | 0.90 | 1.10 | |
| J | 0.003 | 0.007 | 0.08 | 0.18 | |
| K | 0.012 | 0.020 | 0.30 | 0.51 | |
| L | 0.007 | 0.020 | 0.20 | 0.50 | |

Suggested Solder Pad Layout

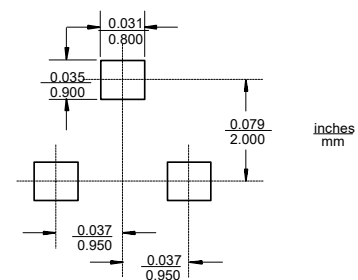

Electrical Characteristics @ 25°C Unless Otherwise Specified

| Parameter | Symbol | Min | Typ | Max | Unit | Conditions |
|----------------------|--------------|------|-----|-------|------------|----------------------------------|
| Input Voltage | $V_{I(off)}$ | -0.3 | --- | --- | V | $V_{CC}=-5V, I_O=-100\mu A$ |
| | $V_{I(on)}$ | --- | --- | -1.4 | V | $V_O=-0.3V, I_O=-1mA$ |
| Output Voltage | $V_{O(on)}$ | --- | --- | -0.3 | V | $I_O=-5mA, I_I=-0.25mA$ |
| Input Current | I_I | --- | --- | -0.88 | mA | $V_I=-5V$ |
| Output Current | $I_{O(off)}$ | --- | --- | -0.5 | μA | $V_{CC}=-50V, V_I=0$ |
| DC Current Gain | G_I | 68 | --- | --- | | $V_O=-5V, I_O=-5mA$ |
| Input Resistance | R_1 | 7.0 | 10 | 13 | K Ω | |
| Resistance Ratio | R_2/R_1 | 3.7 | 4.7 | 5.7 | | |
| Transition Frequency | f_T | --- | 250 | --- | MHz | $V_{CE}=-10V, I_E=5mA, f=100MHz$ |

Curve Characteristics

Fig. 1 - DC Current Gain Characteristics

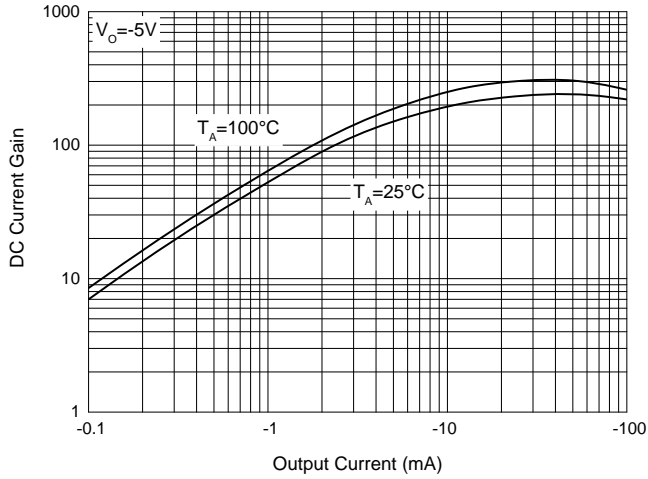

Fig. 2 - Input Voltage (on) Characteristics

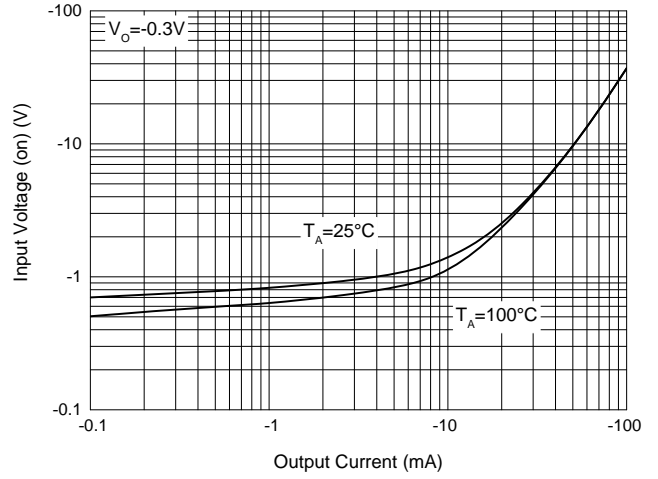

Fig. 3 - Input Voltage (off) Characteristics

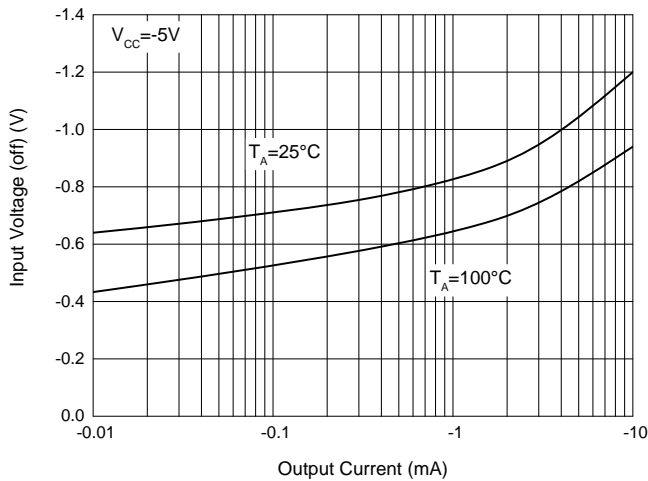

Fig. 4 - Output Voltage Characteristics

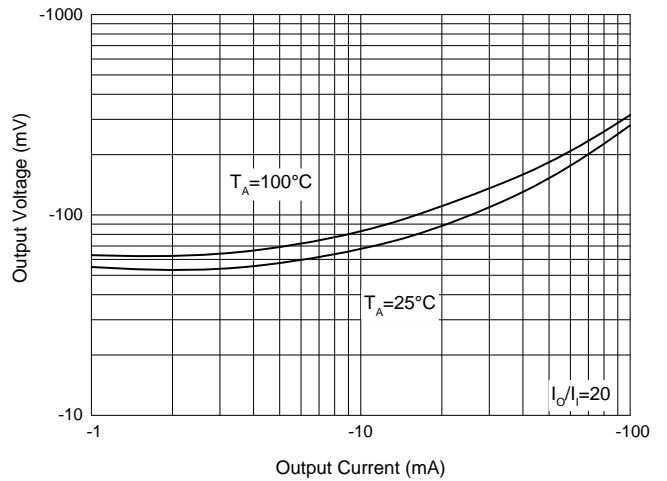
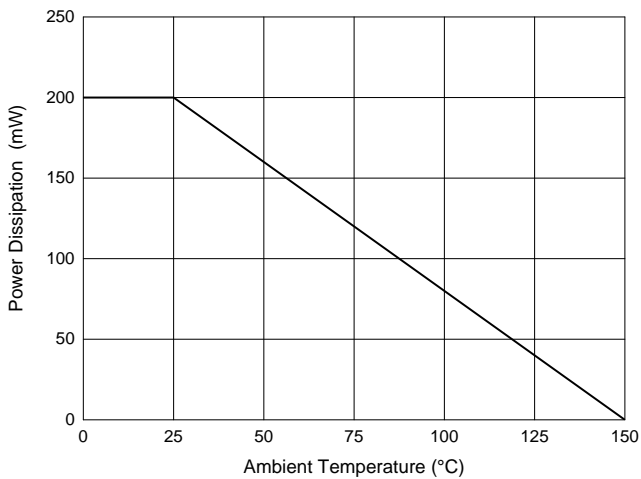

Fig. 5 - Power Derating Curve



Ordering Information

| Device | Packing |
|----------------|----------------------|
| Part Number-TP | Tape&Reel:3Kpcs/Reel |

IMPORTANT NOTICE

Micro Commercial Components Corp. reserves the right to make changes without further notice to any product herein to make corrections, modifications , enhancements , improvements , or other changes . **Micro Commercial Components Corp** . does not assume any liability arising out of the application or use of any product described herein; neither does it convey any license under its patent rights ,nor the rights of others . The user of products in such applications shall assume all risks of such use and will agree to hold **Micro Commercial Components Corp** . and all the companies whose products are represented on our website, harmless against all damages. **Micro Commercial Components Corp.** products are sold subject to the general terms and conditions of commercial sale, as published at <https://www.mccsemi.com/Home/TermsAndConditions>.

LIFE SUPPORT

MCC's products are not authorized for use as critical components in life support devices or systems without the express written approval of Micro Commercial Components Corporation.

CUSTOMER AWARENESS

Counterfeiting of semiconductor parts is a growing problem in the industry. Micro Commercial Components (MCC) is taking strong measures to protect ourselves and our customers from the proliferation of counterfeit parts. MCC strongly encourages customers to purchase MCC parts either directly from MCC or from Authorized MCC Distributors who are listed by country on our web page cited below. Products customers buy either from MCC directly or from Authorized MCC Distributors are genuine parts, have full traceability, meet MCC's quality standards for handling and storage. **MCC will not provide any warranty coverage or other assistance for parts bought from Unauthorized Sources.** MCC is committed to combat this global problem and encourage our customers to do their part in stopping this practice by buying direct or from authorized distributors.

单击下面可查看定价，库存，交付和生命周期等信息

[>>MCC\(美微科\)](#)