

## Features

- High Speed Smooth Switching Device for Hard and Soft Switching
- $V_{ce(sat)}$  with Positive Temperature Coefficient
- High Ruggedness, Good Thermal Stability
- Very Tight Parameter Distribution
- Halogen Free. "Green" Device (Note 1)
- Epoxy Meets UL 94 V-0 Flammability Rating
- Lead Free Finish/RoHS Compliant ("P" Suffix Designates RoHS Compliant. See Ordering Information)

## Maximum Ratings

- Operating Junction Temperature Range :  $-40^{\circ}\text{C}$  to  $+175^{\circ}\text{C}$
- Storage Temperature Range:  $-55^{\circ}\text{C}$  to  $+150^{\circ}\text{C}$
- IGBT Thermal Resistance:  $0.46^{\circ}\text{C/W}$  Junction to Case
- Diode Thermal Resistance:  $0.51^{\circ}\text{C/W}$  Junction to Case
- Thermal Resistance:  $40^{\circ}\text{C/W}$  Junction to Ambient

Parameter	Symbol	Rating	Unit
Collector-Emitter Voltage	$V_{CE}$	650	V
DC Collector Current <sup>(2)</sup>	$I_C$	$T_C=25^{\circ}\text{C}$	85
		$T_C=100^{\circ}\text{C}$	60
Pulsed Collector Current <sup>(3)</sup>	$I_{C,pluse}$	200	A
Diode Forward Current <sup>(2)</sup>	$I_F$	$T_C=25^{\circ}\text{C}$	85
		$T_C=100^{\circ}\text{C}$	60
Diode Pulsed Current <sup>(3)</sup>	$I_{F,pluse}$	200	A
Gate-Emitter Voltage	$V_{GE}$	$\pm 20$	V
Transient Gate-Emitter Voltage <sup>(4)</sup>		$\pm 30$	
Power Dissipation	$P_D$	$T_C=25^{\circ}\text{C}$	326
		$T_C=100^{\circ}\text{C}$	163

Note:

1. Halogen free "Green" products are defined as those which contain <900ppm bromine, <900ppm chlorine (<1500ppm total Br + Cl) and <1000ppm antimony compounds.
2. Limited by  $T_{Jmax}$ .
3.  $T_p$  limited by  $T_{Jmax}$ .
4.  $T_p \leq 10\mu\text{s}$ , Duty Cycle < 1%
5. Allowed number of short circuits: < 1000; time between short circuits: > 1s.

## Internal Structure

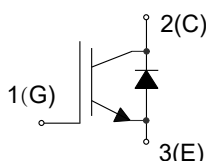

# Trench and Field Stop IGBT 650V 50A

## TO-247AB

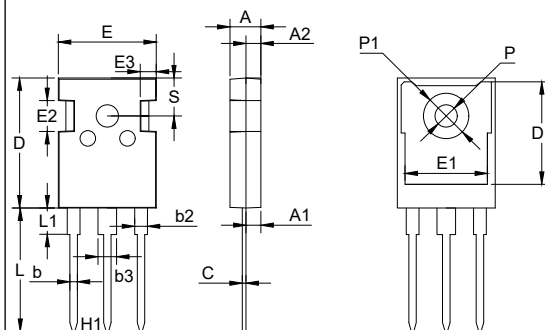

### DIMENSIONS

DIM	INCHES		MM		NOTE
	MIN	MAX	MIN	MAX	
A	0.189	0.205	4.80	5.20	
A1	0.087	0.103	2.21	2.61	
A2	0.073	0.085	1.85	2.15	
b	0.039	0.055	1.00	1.40	
b2	0.075	0.087	1.91	2.21	
C	0.020	0.028	0.50	0.70	
D	0.815	0.839	20.70	21.30	
D1	0.640	0.663	16.25	16.85	
E	0.610	0.634	15.50	16.10	
E1	0.512	0.535	13.00	13.60	
E2	0.189	0.205	4.80	5.20	
E3	0.091	0.106	2.30	2.70	
L	0.772	0.796	19.62	20.22	
L1	-	0.169	-	4.30	
P	0.134	0.150	3.40	3.80	Φ
P1		0.287	-	7.30	Φ
S	0.242		6.15		TYP
H1	0.214		5.44		TYP
b3	0.110	0.126	2.80	3.20	

**Electrical Characteristics @ 25°C (Unless Otherwise Specified)**

Parameter	Symbol	Test Conditions	Min	Typ	Max	Unit
<b>Static Characteristics</b>						
Collector-Emitter Breakdown Voltage	$V_{(BR)CES}$	$V_{GE}=0V, I_C=250\mu A$	650			V
Collector-Emitter Saturation Voltage	$V_{CE(sat)}$	$V_{GE}=15V, I_C=50A, T_J=25^\circ C$		1.60	1.95	V
		$V_{GE}=15V, I_C=50A, T_J=125^\circ C$		1.95		
		$V_{GE}=15V, I_C=50A, T_J=150^\circ C$		2.05		
G-E Threshold Voltage	$V_{GE(th)}$	$I_C=0.75mA, V_{CE}=V_{GE}$	4.25	5.05	5.85	V
C-E Leakage Current	$I_{CES}$	$V_{CE}=650V, V_{GE}=0V$			0.25	mA
G-E Leakage Current	$I_{GES}$	$V_{CE}=0V, V_{GE}=\pm 20V$			200	nA
<b>Dynamic Characteristics</b>						
Input Capacitance	$C_{ies}$	$V_{CE}=25V, V_{GE}=0V, f=1MHz$		5.92		nF
Reverse Transfer Capacitance	$C_{res}$			0.23		
Gate Charge	$Q_g$	$V_{CC}=300V, I_C=50A, V_{GE}=15V$		0.45		uC
<b>IGBT Switching Characteristics</b>						
Turn-On Delay Time	$td_{(on)}$	$V_{CC}=300V, I_C=50A, V_{GE}=0/15V, R_G=10\Omega, L_S=60nH, T_J=25^\circ C$		55		ns
Rise Time	$t_r$			56		
Turn-Off Delay Time	$td_{(off)}$			319		
Fall Time	$t_f$			24		
Turn-On Energy	$E_{on}$			1.27		mJ
Turn-Off Energy	$E_{off}$			0.65		
Turn-On Delay Time	$td_{(on)}$	$V_{CC}=300V, I_C=50A, V_{GE}=0/15V, R_G=10\Omega, L_S=60nH, T_J=125^\circ C$		53		ns
Rise Time	$t_r$			61		
Turn-Off Delay Time	$td_{(off)}$			351		
Fall Time	$t_f$			59		
Turn-On Energy	$E_{on}$			1.51		mJ
Turn-Off Energy	$E_{off}$			0.8		
Turn-On Delay Time	$td_{(on)}$	$V_{CC}=300V, I_C=50A, V_{GE}=0/15V, R_G=10\Omega, L_S=60nH, T_J=150^\circ C$		52		ns
Rise Time	$t_r$			60		
Turn-Off Delay Time	$td_{(off)}$			361		
Fall Time	$t_f$			71		
Turn-On Energy	$E_{on}$			1.62		mJ
Turn-Off Energy	$E_{off}$			0.85		

**Electrical Characteristics @ 25°C (Unless Otherwise Specified)**

Parameter	Symbol	Test Conditions	Min	Typ	Max	Unit
<b>Diode Characteristics</b>						
Diode Forward Voltage	$V_F$	$V_{GE}=0V, I_F=50A, T_J=25^\circ C$		1.45	1.80	V
		$V_{GE}=0V, I_F=50A, T_J=125^\circ C$		1.29		
		$V_{GE}=0V, I_F=50A, T_J=150^\circ C$		1.23		
Reverse Recovery Current	$I_{rr}$	$V_R=300V, I_F=50A,$ $di_F/dt=-610A/\mu s, T_J=25^\circ C$		13		A
Reverse Recovery Charge	$Q_{rr}$			0.78		$\mu C$
Reverse Recovery Energy	$E_{rec}$			0.1		mJ
Reverse Recovery Current	$I_{rr}$	$V_R=300V, I_F=50A,$ $di_F/dt=-610A/\mu s, T_J=125^\circ C$		35		A
Reverse Recovery Charge	$Q_{rr}$			2.8		$\mu C$
Reverse Recovery Energy	$E_{rec}$			0.38		mJ
Reverse Recovery Current	$I_{rr}$	$V_R=300V, I_F=50A,$ $di_F/dt=-610A/\mu s, T_J=150^\circ C$		40		A
Reverse Recovery Charge	$Q_{rr}$			3.22		$\mu C$
Reverse Recovery Energy	$E_{rec}$			0.43		mJ

Curve Characteristics

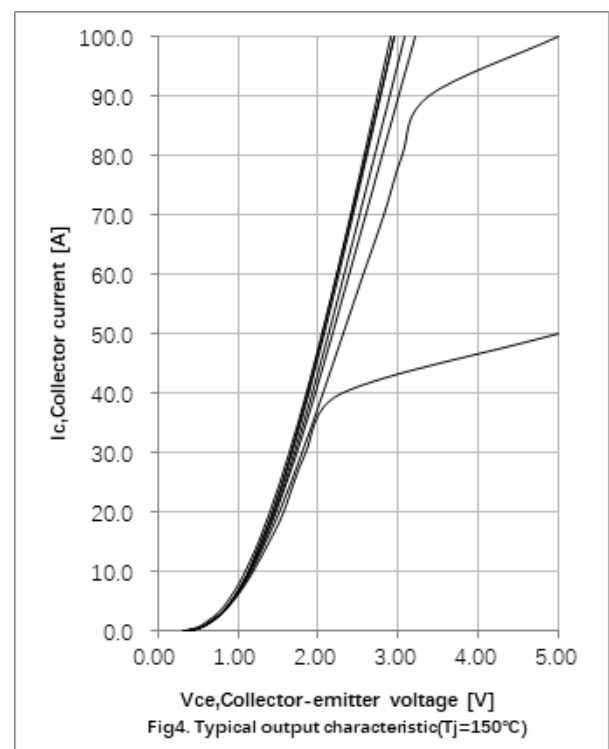
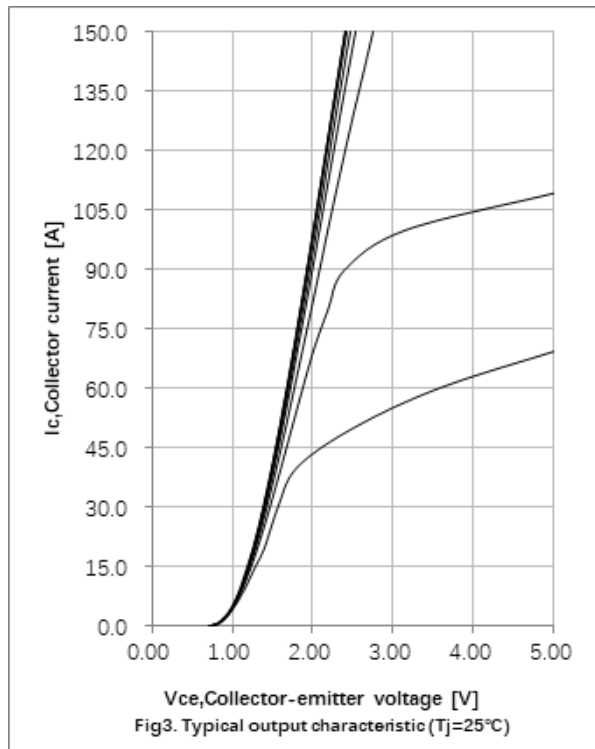
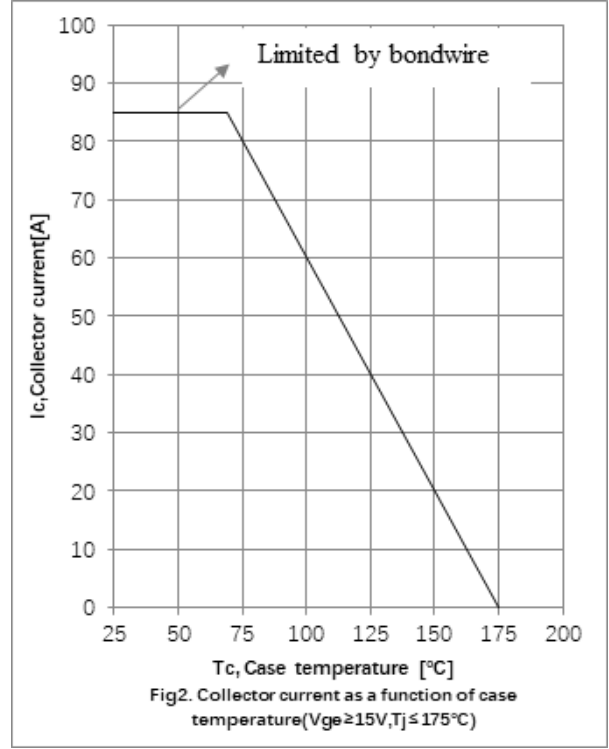
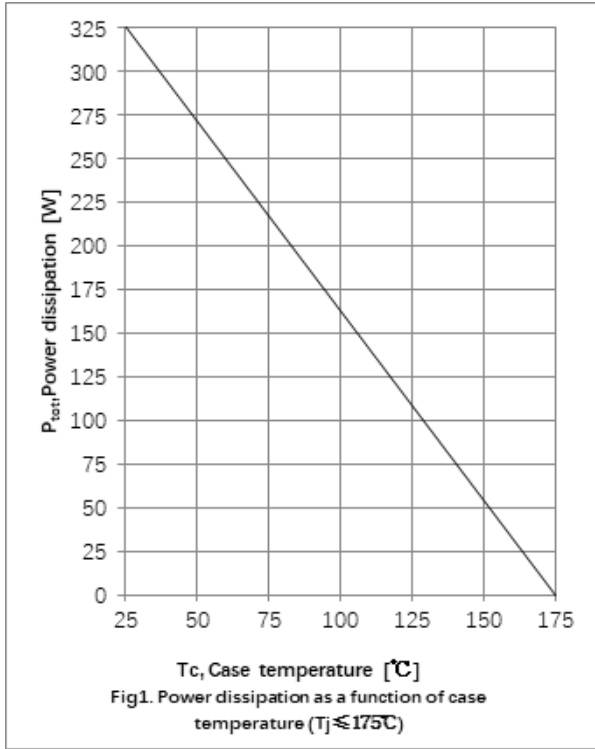

Curve Characteristics

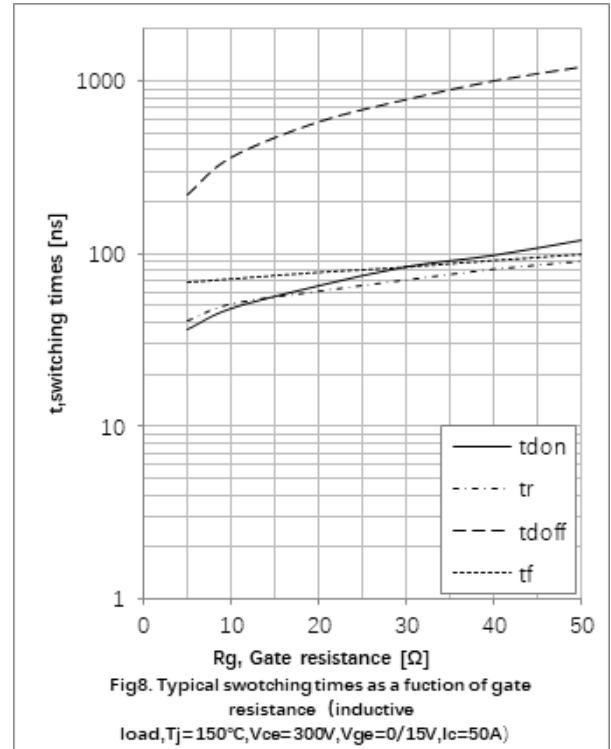
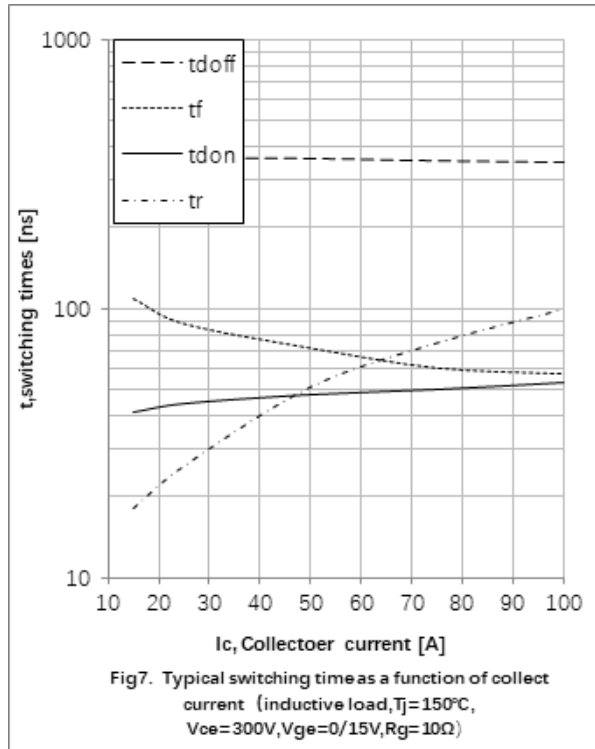
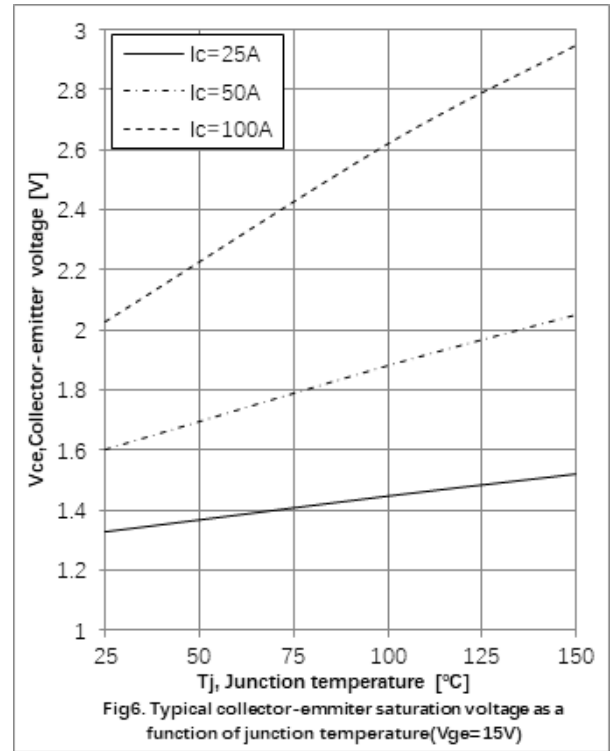
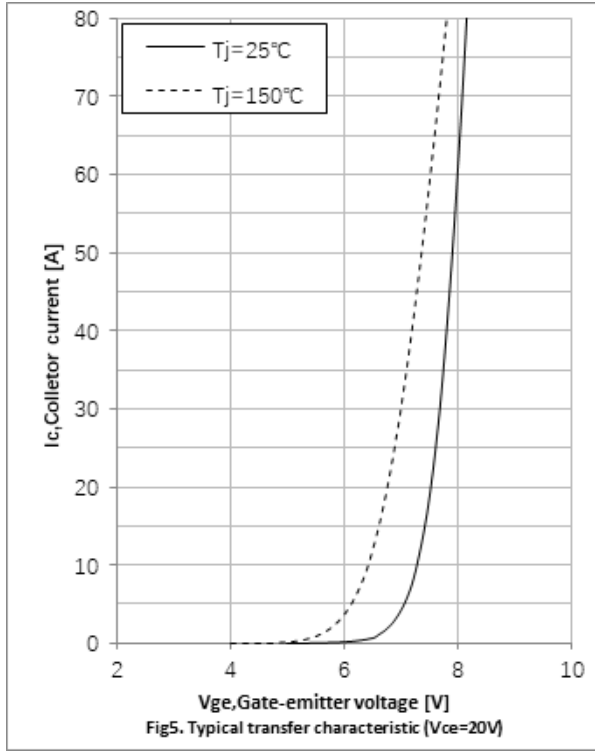

Curve Characteristics

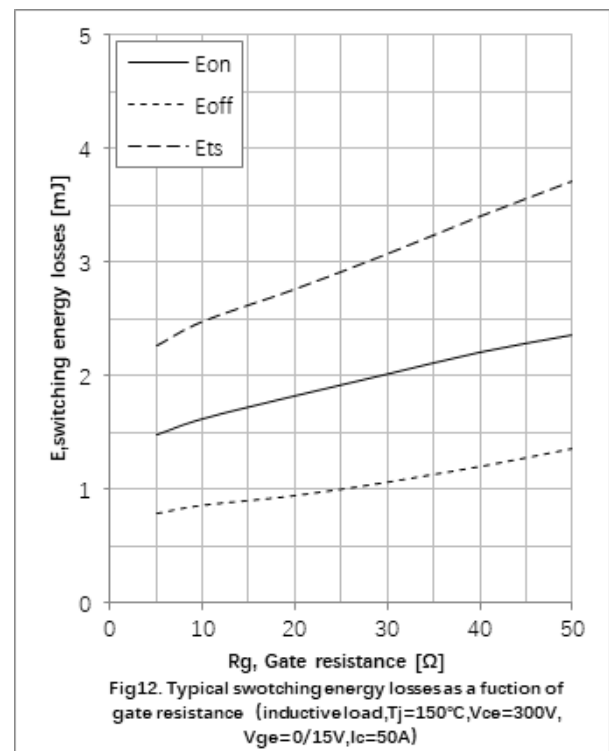
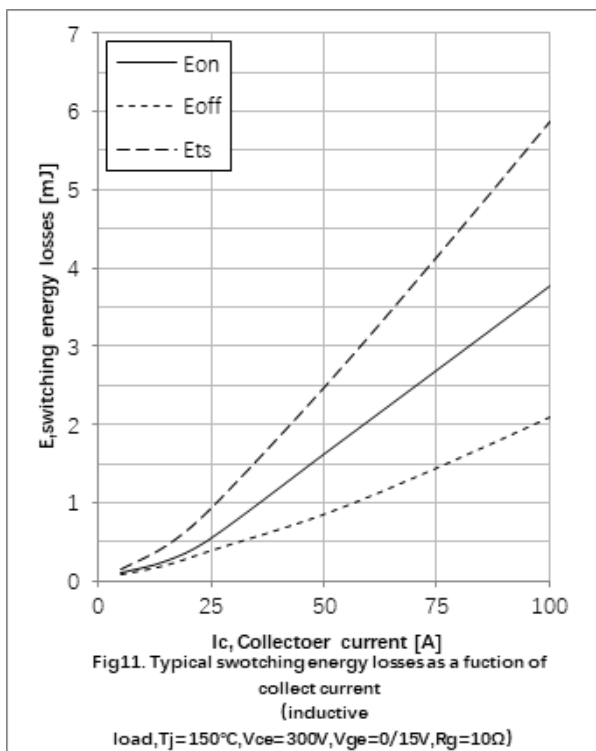
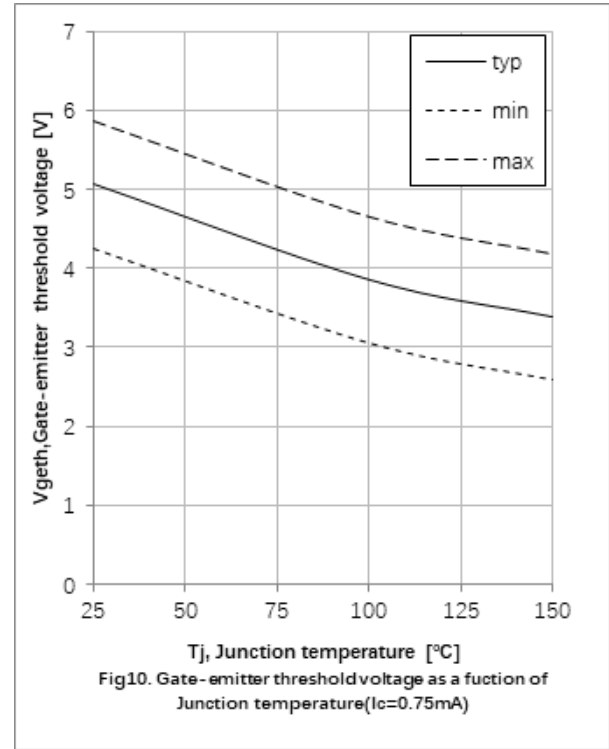
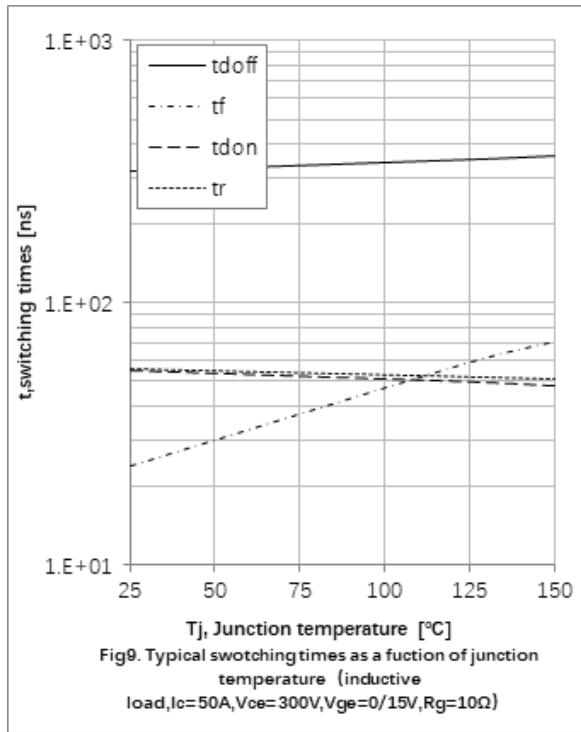

Curve Characteristics

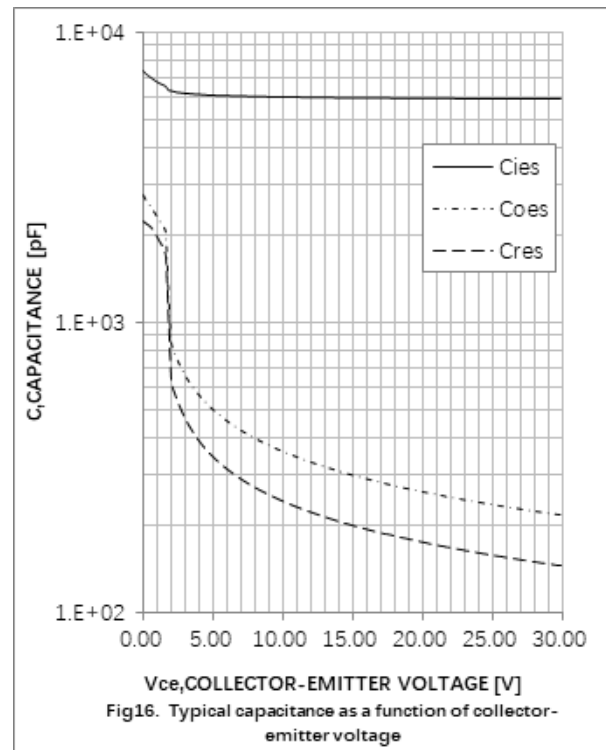
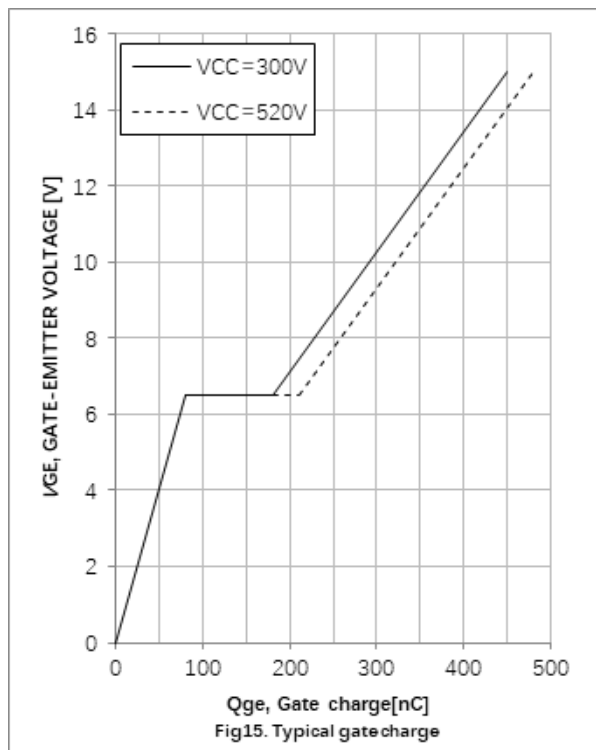
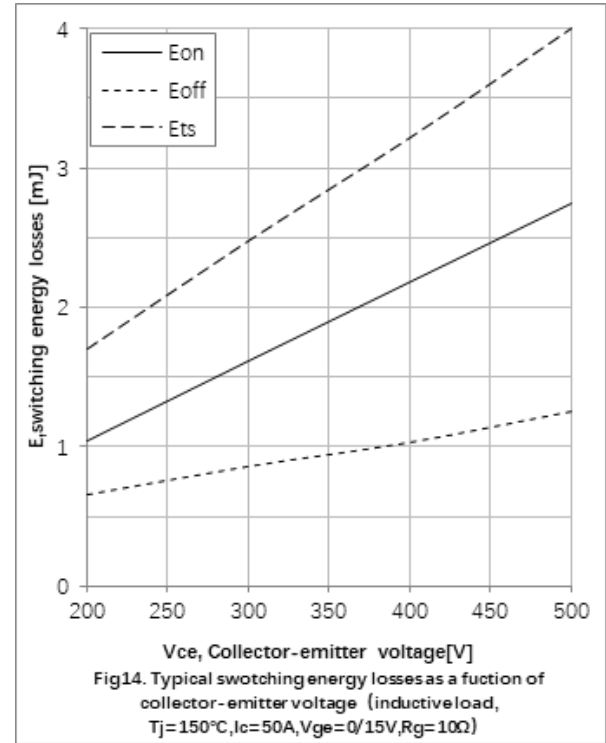
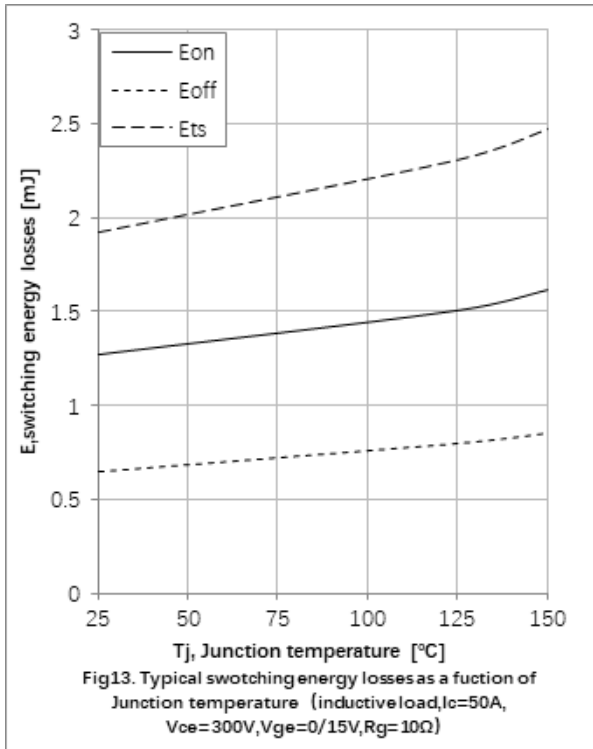

Curve Characteristics

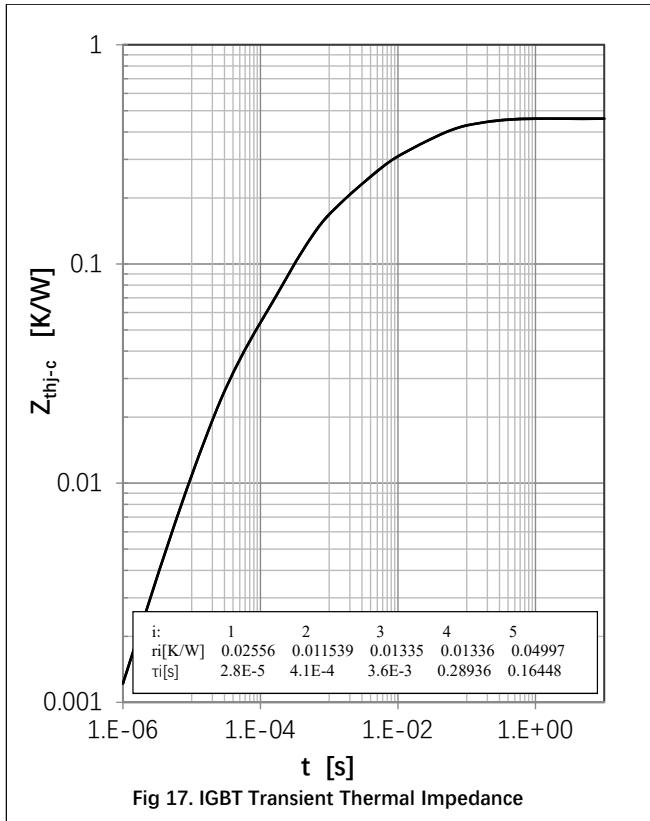

Fig 17. IGBT Transient Thermal Impedance

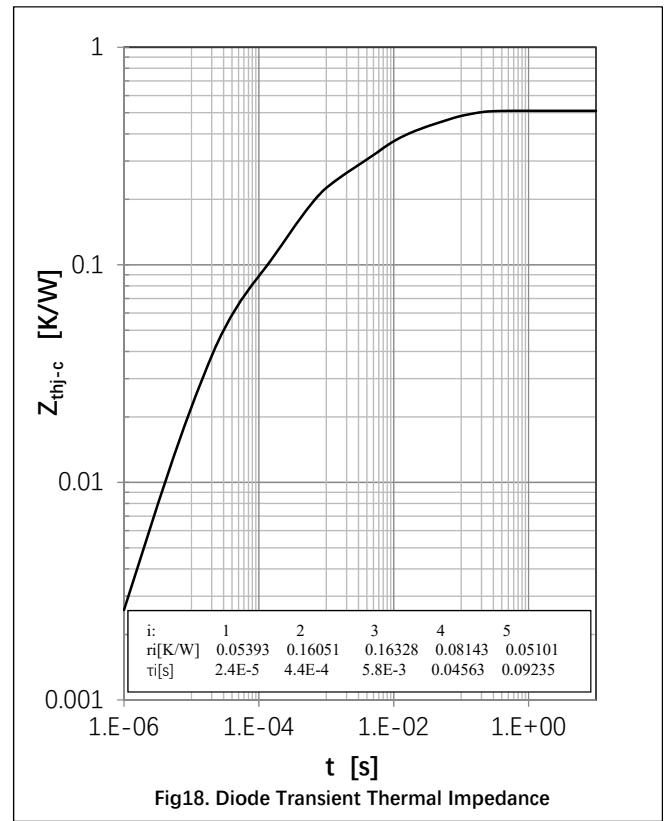

Fig 18. Diode Transient Thermal Impedance

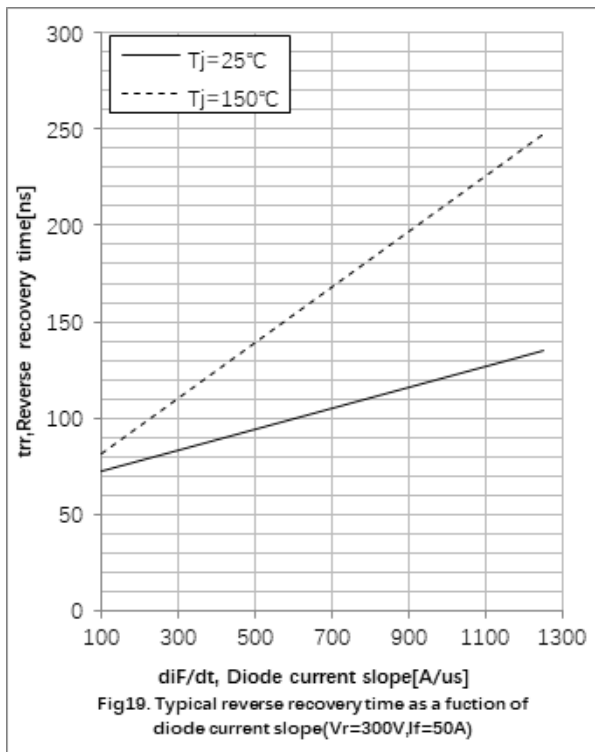

Fig 19. Typical reverse recovery time as a function of diode current slope (Vr=300V, If=50A)

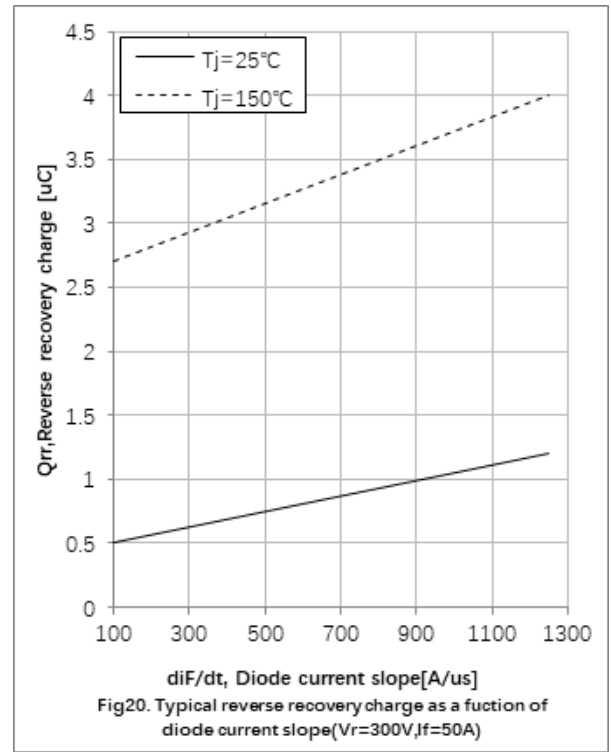
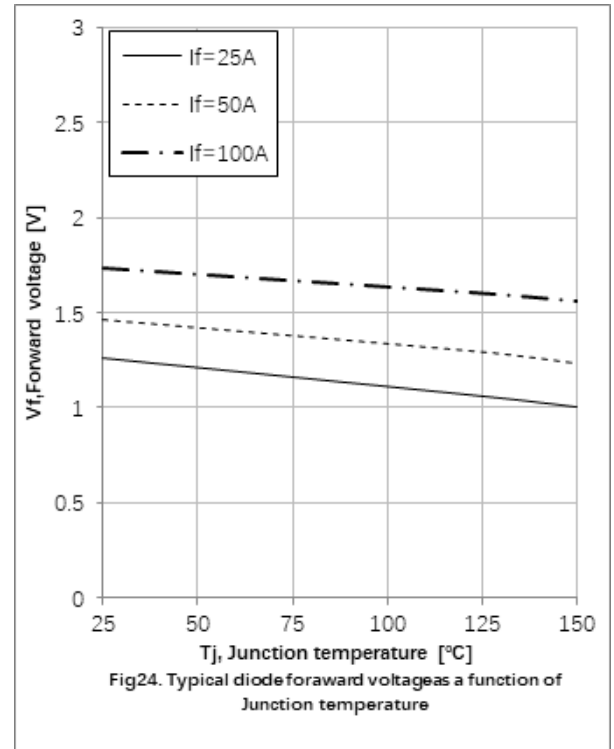
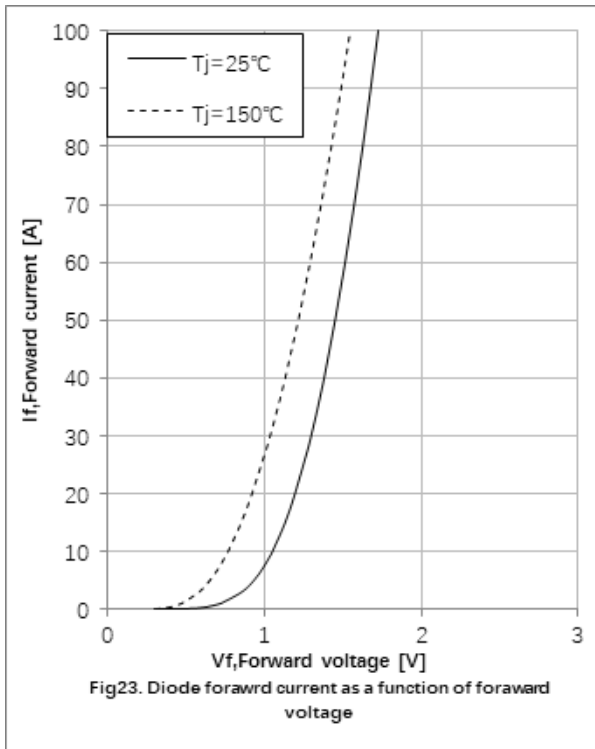
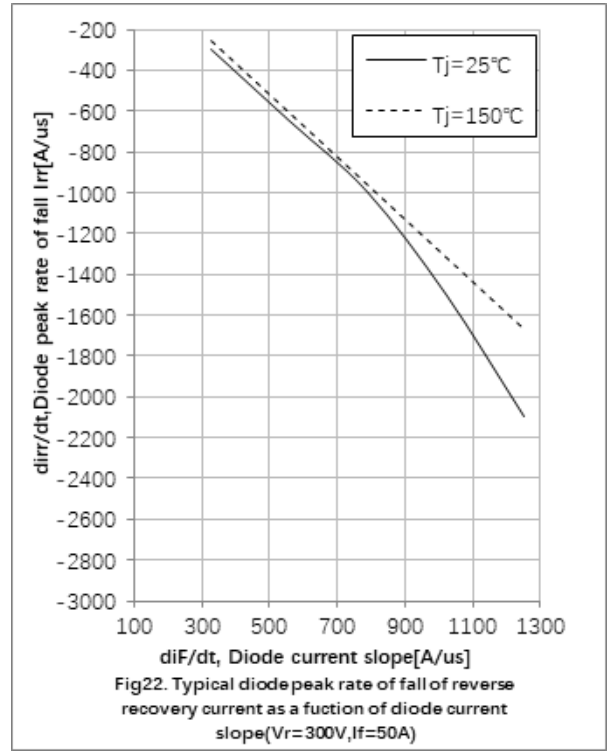
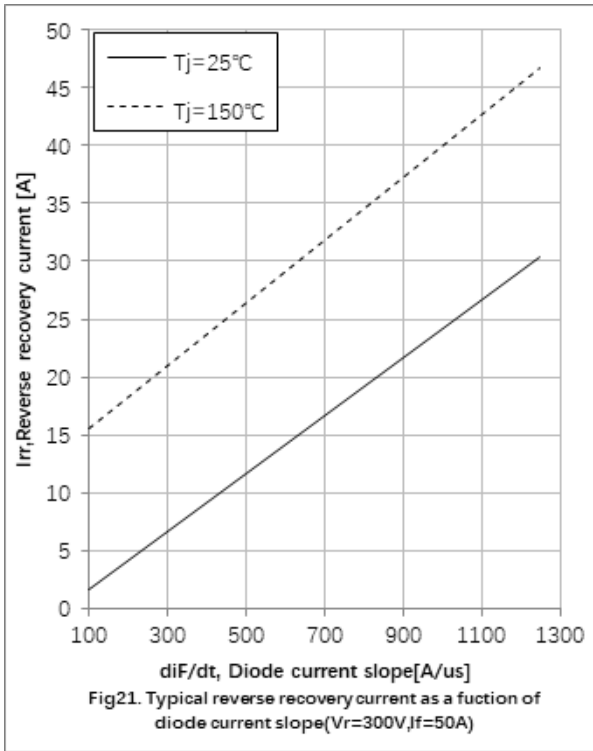

Fig 20. Typical reverse recovery charge as a function of diode current slope (Vr=300V, If=50A)



Curve Characteristics



## Ordering Information

Device	Packing
Part Number-BP	Tube: 30pcs/Tube, 1800pcs/Ctn

**\*\*\*IMPORTANT NOTICE\*\*\***

*Micro Commercial Components Corp.* reserves the right to make changes without further notice to any product herein to make corrections, modifications, enhancements, improvements, or other changes. *Micro Commercial Components Corp.* does not assume any liability arising out of the application or use of any product described herein; neither does it convey any license under its patent rights, nor the rights of others. The user of products in such applications shall assume all risks of such use and will agree to hold *Micro Commercial Components Corp.* and all the companies whose products are represented on our website, harmless against all damages. *Micro Commercial Components Corp.* products are sold subject to the general terms and conditions of commercial sale, as published at <https://www.mccsemi.com/Home/TermsAndConditions>.

**\*\*\*LIFE SUPPORT\*\*\***

MCC's products are not authorized for use as critical components in life support devices or systems without the express written approval of Micro Commercial Components Corporation.

**\*\*\*CUSTOMER AWARENESS\*\*\***

Counterfeiting of semiconductor parts is a growing problem in the industry. Micro Commercial Components (MCC) is taking strong measures to protect ourselves and our customers from the proliferation of counterfeit parts. MCC strongly encourages customers to purchase MCC parts either directly from MCC or from Authorized MCC Distributors who are listed by country on our web page cited below. Products customers buy either from MCC directly or from Authorized MCC Distributors are genuine parts, have full traceability, meet MCC's quality standards for handling and storage. **MCC will not provide any warranty coverage or other assistance for parts bought from Unauthorized Sources.** MCC is committed to combat this global problem and encourage our customers to do their part in stopping this practice by buying direct or from authorized distributors.

单击下面可查看定价，库存，交付和生命周期等信息

[>>MCC\(美微科\)](#)