

	E480232
---	----------------

Features

- For Surface Mount Applications in Order to Optimize Board Space
- Low Inductance
- Fast Response Time: Typical Less than 1ps From 0V to V_{BR} min
- Halogen Free. "Green" Device (Note 1)
- Moisture Sensitivity Level 1
- Epoxy Meets UL 94 V-0 Flammability Rating
- Lead Free Finish/RoHS Compliant (Note 2) ("P" Suffix Designates RoHS Compliant. See Ordering Information)
- For Bidirectional Devices Add "C" To The Suffix of The Part Number: i.e.SMBJ5.0CA for 5% Tolerance

Mechanical Data

- Polarity: Color Band Denotes Positive end(cathode) Except Bi-directional Types
- Maximum Soldering Temperature: 260°C for 10 Seconds
- Terminals: Solderable Per MIL-STD-750, Method 2026

Maximum Ratings

- Operating Junction Temperature Range: -55°C to +175°C
- Storage Temperature Range: -55°C to +175°C
- Thermal Resistance :20°C/W Junction to Lead
- Thermal Resistance :25°C/W Junction to Case
- Thermal Resistance :100°C/W Junction to Ambient

Electrical Characteristics @ 25°C Unless Otherwise Specified

Peak Pulse Power Surge Current on 10/1000µs Waveform	I_{PP}	See the Table	Note 3
Peak Pulse Power Dissipation	P_{PP}	600W	Note 3,4,5
Steady State Power Dissipation	$P_{M(AV)}$	5.0W	Note 6
Peak Forward Surge Current	I_{FSM}	100A	8.3 ms Single Half Sine-Wave Unidirectional Only

NOTES:

1. Halogen free "Green" products are defined as those which contain <900ppm bromine, <900ppm chlorine (<1500ppm total Br + Cl) and <1000ppm antimony compounds.
2. High Temperature Solder Exemption Applied, see EU Directive Annex 7a.
3. Non-repetitive current pulse, per Fig.3 and derated above $T_A=25^\circ\text{C}$ per Fig.4
4. Mounted on 5.0mm² copper pads to each terminal.
5. Peak pulse current waveform is 10/1000us, with maximum duty Cycle of 0.01%.
6. Power dissipation, on infinite heat sink at $T_L=75^\circ\text{C}$

Pin Configuration:

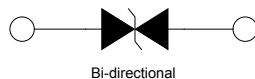
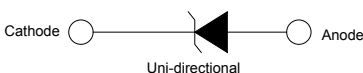

**600 Watt TVS
5.0 to 440 Volts**

**SMB (DO-214AA)
(LEAD FRAME)**

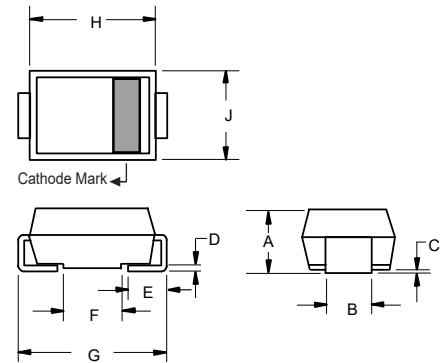

DIM	INCHES		MM		NOTE
	MIN	MAX	MIN	MAX	
A	0.079	0.103	2.00	2.62	
B	0.075	0.087	1.91	2.21	
C	0.002	0.008	0.05	0.20	
D	0.006	0.012	0.15	0.31	
E	0.030	0.060	0.76	1.52	
F	0.065	0.091	1.65	2.32	
G	0.200	0.220	5.08	5.59	
H	0.160	0.191	4.06	4.85	
J	0.130	0.155	3.30	3.94	

Suggested Solder Pad Layout

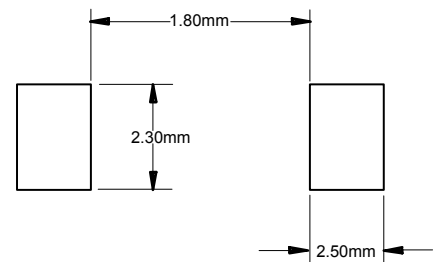

Electrical Characteristics @ 25°C Unless Otherwise Specified

MCC PART NUMBER	REVERSE STAND-OFF VOLTAGE V_{WM}	BREAKDOWN VOLTAGE $V_{(BR)} @ I_T$ (VOLTS)			MAXIMUM CLAMPING VOLTAGE @ I_{PP}	PEAK PULSE CURRENT I_{PP}	MAXIMUM REVERSE LEAKAGE @ V_{WM} I_D	MARKING CODE
	VOLTS	MIN	MAX	I_T (mA)	VOLTS	(AMPS)	(μ A)	
SMBJ5.0	5.0	6.40	7.30	10	9.6	62.5	800	KD
SMBJ5.0A	5.0	6.40	7.00	10	9.2	65.2	800	KE
SMBJ6.0	6.0	6.67	8.15	10	11.4	52.6	800	KF
SMBJ6.0A	6.0	6.67	7.37	10	10.3	58.3	800	KG
SMBJ6.5	6.5	7.22	8.82	10	12.3	48.7	500	KH
SMBJ6.5A	6.5	7.22	7.98	10	11.2	53.6	500	KK
SMBJ7.0	7.0	7.78	9.51	10	13.3	45.1	200	KL
SMBJ7.0A	7.0	7.78	8.60	10	12.0	50.0	200	KM
SMBJ7.5	7.5	8.33	10.2	1	14.3	42.0	100	KN
SMBJ7.5A	7.5	8.33	9.21	1	12.9	46.5	100	KP
SMBJ8.0	8.0	8.89	10.9	1	15.0	40.0	50	KQ
SMBJ8.0A	8.0	8.89	9.83	1	13.6	44.1	50	KR
SMBJ8.5	8.5	9.44	11.5	1	15.9	37.7	10	KS
SMBJ8.5A	8.5	9.44	10.4	1	14.4	41.7	10	KT
SMBJ9.0	9.0	10.0	12.2	1	16.9	35.5	5	KU
SMBJ9.0A	9.0	10.0	11.1	1	15.4	39.0	5	KV
SMBJ10	10	11.1	13.6	1	18.8	31.9	1	KW
SMBJ10A	10	11.1	12.3	1	17.0	35.3	1	KX
SMBJ11	11	12.2	14.9	1	20.1	29.9	1	KY
SMBJ11A	11	12.2	13.5	1	18.2	33.0	1	KZ
SMBJ12	12	13.3	16.3	1	22.0	27.3	1	LD
SMBJ12A	12	13.3	14.7	1	19.9	30.2	1	LE
SMBJ13	13	14.4	17.6	1	23.8	25.2	1	LF
SMBJ13A	13	14.4	15.9	1	21.5	27.9	1	LG
SMBJ14	14	15.6	19.1	1	25.8	23.3	1	LH
SMBJ14A	14	15.6	17.2	1	23.2	25.8	1	LK
SMBJ15	15	16.7	20.4	1	26.9	22.3	1	LL
SMBJ15A	15	16.7	18.5	1	24.4	24.0	1	LM
SMBJ16	16	17.8	21.8	1	28.8	20.8	1	LN
SMBJ16A	16	17.8	19.7	1	26.0	23.1	1	LP
SMBJ17	17	18.9	23.1	1	30.5	19.7	1	LQ
SMBJ17A	17	18.9	20.9	1	27.6	21.7	1	LR
SMBJ18	18	20.0	24.4	1	32.2	18.6	1	LS
SMBJ18A	18	20.0	22.1	1	29.2	20.5	1	LT
SMBJ20	20	22.2	27.1	1	35.8	16.7	1	LU
SMBJ20A	20	22.2	24.5	1	32.4	18.5	1	LV
SMBJ22	22	24.4	29.8	1	39.4	15.2	1	LW
SMBJ22A	22	24.4	26.9	1	35.5	16.9	1	LX
SMBJ24	24	26.7	32.6	1	43.0	14.0	1	LY
SMBJ24A	24	26.7	29.5	1	38.9	15.4	1	LZ
SMBJ26	26	28.9	35.3	1	46.6	12.4	1	MD
SMBJ26A	26	28.9	31.9	1	42.1	14.2	1	ME
SMBJ28	28	31.1	38.0	1	50.0	12.0	1	MF
SMBJ28A	28	31.1	34.4	1	45.4	13.2	1	MG
SMBJ30	30	33.3	40.7	1	53.5	11.2	1	MH
SMBJ30A	30	33.3	36.8	1	48.4	12.4	1	MK

For parts without A, the VBR is +10%.

Electrical Characteristics @ 25°C Unless Otherwise Specified

MCC PART NUMBER	REVERSE STAND-OFF VOLTAGE V_{WM}	BREAKDOWN VOLTAGE $V_{(BR)} @ I_T$ (VOLTS)			MAXIMUM CLAMPING VOLTAGE @ I_{PP}	PEAK PULSE CURRENT I_{PP}	MAXIMUM REVERSE LEAKAGE @ V_{WM} I_D	MARKING CODE
	VOLTS	MIN	MAX	I_T (mA)	VOLTS	(AMPS)	(μ A)	
SMBJ33	33	36.7	44.9	1	59.0	10.2	1	ML
SMBJ33A	33	36.7	40.6	1	53.3	11.3	1	MM
SMBJ36	36	40.0	48.9	1	64.3	9.3	1	MN
SMBJ36A	36	40.0	44.2	1	58.1	10.3	1	MP
SMBJ40	40	44.4	54.3	1	71.4	8.4	1	MQ
SMBJ40A	40	44.4	49.1	1	64.5	9.3	1	MR
SMBJ43	43	47.8	58.4	1	76.7	7.8	1	MS
SMBJ43A	43	47.8	52.8	1	69.4	8.6	1	MT
SMBJ45	45	50.0	61.1	1	80.3	7.5	1	MU
SMBJ45A	45	50.0	55.3	1	72.7	8.3	1	MV
SMBJ48	48	53.3	65.1	1	85.5	7.0	1	MW
SMBJ48A	48	53.3	58.9	1	77.4	7.7	1	MX
SMBJ51	51	56.7	69.3	1	91.1	6.6	1	MY
SMBJ51A	51	56.7	62.7	1	82.4	7.3	1	MZ
SMBJ54	54	60.0	73.3	1	96.3	6.2	1	ND
SMBJ54A	54	60.0	66.3	1	87.1	6.9	1	NE
SMBJ58	58	64.4	78.7	1	103	5.8	1	NF
SMBJ58A	58	64.4	71.2	1	93.6	6.4	1	NG
SMBJ60	60	66.7	81.5	1	107	5.6	1	NH
SMBJ60A	60	66.7	73.7	1	96.8	6.2	1	NK
SMBJ64	64	71.1	86.9	1	114	5.3	1	NL
SMBJ64A	64	71.1	78.6	1	103	5.8	1	NM
SMBJ70	70	77.8	95.1	1	125	4.8	1	NN
SMBJ70A	70	77.8	86.0	1	113	5.3	1	NP
SMBJ75	75	83.3	102	1	134	4.5	1	NQ
SMBJ75A	75	83.3	92.1	1	121	4.9	1	NR
SMBJ78	78	86.7	106	1	139	4.3	1	NS
SMBJ78A	78	86.7	95.8	1	126	4.7	1	NT
SMBJ85	85	94.4	115	1	151	3.9	1	NU
SMBJ85A	85	94.4	104	1	137	4.4	1	NV
SMBJ90	90	100	122	1	160	3.8	1	NW
SMBJ90A	90	100	111	1	146	4.1	1	NX
SMBJ100	100	111	136	1	179	3.4	1	NY
SMBJ100A	100	111	123	1	162	3.7	1	NZ
SMBJ110	110	122	149	1	196	3.0	1	PD
SMBJ110A	110	122	135	1	177	3.4	1	PE
SMBJ120	120	133	163	1	214	2.8	1	PF
SMBJ120A	120	133	147	1	193	3.1	1	PG
SMBJ130	130	144	176	1	231	2.6	1	PH
SMBJ130A	130	144	159	1	209	2.9	1	PK
SMBJ150	150	167	204	1	268	2.2	1	PL
SMBJ150A	150	167	185	1	243	2.5	1	PM
SMBJ160	160	178	218	1	287	2.1	1	PN
SMBJ160A	160	178	197	1	259	2.3	1	PP
SMBJ170	170	189	231	1	304	2.0	1	PQ
SMBJ170A	170	189	209	1	275	2.2	1	PR
SMBJ180A	180	201	222	1	292	2.1	1	PT

For parts without A, the VBR is +10%.

Electrical Characteristics @ 25°C Unless Otherwise Specified

MCC PART NUMBER	REVERSE STAND-OFF VOLTAGE V_{WM}	BREAKDOWN VOLTAGE $V_{(BR)} @ I_T$ (VOLTS)			MAXIMUM CLAMPING VOLTAGE @ I_{PP}	PEAK PULSE CURRENT I_{PP}	MAXIMUM REVERSE LEAKAGE @ V_{WM} I_D	MARKING CODE
	VOLTS	MIN	MAX	I_T (mA)	VOLTS	(AMPS)	(μ A)	
SMBJ200A	200	224	247	1	324	1.9	1	PV
SMBJ220A	220	246	272	1	356	1.7	1	PX
SMBJ250A	250	279	309	1	405	1.5	1	PZ
SMBJ300A	300	335	371	1	486	1.3	1	QE
SMBJ350A	350	391	432	1	567	1.1	1	QG
SMBJ400A	400	447	494	1	648	0.9	1	QK
SMBJ440A	440	492	543	1	713	0.9	1	QM
SMBJ5.0C	5.0	6.40	7.30	10	9.6	62.5	800	AD
SMBJ5.0CA	5.0	6.40	7.00	10	9.2	65.2	800	AE
SMBJ6.0C	6.0	6.67	8.15	10	11.4	52.6	800	AF
SMBJ6.0CA	6.0	6.67	7.37	10	10.3	58.3	800	AG
SMBJ6.5C	6.5	7.22	8.82	10	12.3	48.7	500	AH
SMBJ6.5CA	6.5	7.22	7.98	10	11.2	53.6	500	AK
SMBJ7.0C	7.0	7.78	9.51	10	13.3	45.1	200	AL
SMBJ7.0CA	7.0	7.78	8.60	10	12.0	50.0	200	AM
SMBJ7.5C	7.5	8.33	10.2	1	14.3	42.0	100	AN
SMBJ7.5CA	7.5	8.33	9.21	1	12.9	46.5	100	AP
SMBJ8.0C	8.0	8.89	10.9	1	15.0	40.0	50	AQ
SMBJ8.0CA	8.0	8.89	9.83	1	13.6	44.1	50	AR
SMBJ8.5C	8.5	9.44	11.5	1	15.9	37.7	10	AS
SMBJ8.5CA	8.5	9.44	10.4	1	14.4	41.7	10	AT
SMBJ9.0C	9.0	10.0	12.2	1	16.9	35.5	5	AU
SMBJ9.0CA	9.0	10.0	11.1	1	15.4	39.0	5	AV
SMBJ10C	10	11.1	13.6	1	18.8	31.9	1	AW
SMBJ10CA	10	11.1	12.3	1	17.0	35.3	1	AX
SMBJ11C	11	12.2	14.9	1	20.1	29.9	1	AY
SMBJ11CA	11	12.2	13.5	1	18.2	33.0	1	AZ
SMBJ12C	12	13.3	16.3	1	22.0	27.3	1	BD
SMBJ12CA	12	13.3	14.7	1	19.9	30.2	1	BE
SMBJ13C	13	14.4	17.6	1	23.8	25.2	1	BF
SMBJ13CA	13	14.4	15.9	1	21.5	27.9	1	BG
SMBJ14C	14	15.6	19.1	1	25.8	23.3	1	BH
SMBJ14CA	14	15.6	17.2	1	23.2	25.8	1	BK
SMBJ15C	15	16.7	20.4	1	26.9	22.3	1	BL
SMBJ15CA	15	16.7	18.5	1	24.4	24.0	1	BM
SMBJ16C	16	17.8	21.8	1	28.8	20.8	1	BN
SMBJ16CA	16	17.8	19.7	1	26.0	23.1	1	BP
SMBJ17C	17	18.9	23.1	1	30.5	19.7	1	BQ
SMBJ17CA	17	18.9	20.9	1	27.6	21.7	1	BR
SMBJ18C	18	20.0	24.4	1	32.2	18.6	1	BS
SMBJ18CA	18	20.0	22.1	1	29.2	20.5	1	BT
SMBJ20C	20	22.2	27.1	1	35.8	16.7	1	BU
SMBJ20CA	20	22.2	24.5	1	32.4	18.5	1	BV
SMBJ22C	22	24.4	29.8	1	39.4	15.2	1	BW
SMBJ22CA	22	24.4	26.9	1	35.5	16.9	1	BX
SMBJ24C	24	26.7	32.6	1	43.0	14.0	1	BY
SMBJ24CA	24	26.7	29.5	1	38.9	15.4	1	BZ

For parts without A, the VBR is +10%.

Electrical Characteristics @ 25°C Unless Otherwise Specified

MCC PART NUMBER	REVERSE STAND-OFF VOLTAGE V_{WM}	BREAKDOWN VOLTAGE $V_{(BR)} @ I_T$ (VOLTS)			MAXIMUM CLAMPING VOLTAGE @ I_{PP}	PEAK PULSE CURRENT I_{PP}	MAXIMUM REVERSE LEAKAGE @ V_{WM} I_D	MARKING CODE
	VOLTS	MIN	MAX	I_T (mA)	VOLTS	(AMPS)	(μ A)	
SMBJ26C	26	28.9	35.3	1	46.6	12.4	1	CD
SMBJ26CA	26	28.9	31.9	1	42.1	14.2	1	CE
SMBJ28C	28	31.1	38.0	1	50.0	12.0	1	CF
SMBJ28CA	28	31.1	34.4	1	45.4	13.2	1	CG
SMBJ30C	30	33.3	40.7	1	53.5	11.2	1	CH
SMBJ30CA	30	33.3	36.8	1	48.4	12.4	1	CK
SMBJ33C	33	36.7	44.9	1	59.0	10.2	1	CL
SMBJ33CA	33	36.7	40.6	1	53.3	11.3	1	CM
SMBJ36C	36	40.0	48.9	1	64.3	9.3	1	CN
SMBJ36CA	36	40.0	44.2	1	58.1	10.3	1	CP
SMBJ40C	40	44.4	54.3	1	71.4	8.4	1	CQ
SMBJ40CA	40	44.4	49.1	1	64.5	9.3	1	CR
SMBJ43C	43	47.8	58.4	1	76.7	7.8	1	CS
SMBJ43CA	43	47.8	52.8	1	69.4	8.6	1	CT
SMBJ45C	45	50.0	61.1	1	80.3	7.5	1	CU
SMBJ45CA	45	50.0	55.3	1	72.7	8.3	1	CV
SMBJ48C	48	53.3	65.1	1	85.5	7.0	1	CW
SMBJ48CA	48	53.3	58.9	1	77.4	7.7	1	CX
SMBJ51C	51	56.7	69.3	1	91.1	6.6	1	CY
SMBJ51CA	51	56.7	62.7	1	82.4	7.3	1	CZ
SMBJ54C	54	60.0	73.3	1	96.3	6.2	1	DD
SMBJ54CA	54	60.0	66.3	1	87.1	6.9	1	DE
SMBJ58C	58	64.4	78.7	1	103	5.8	1	DF
SMBJ58CA	58	64.4	71.2	1	93.6	6.4	1	DG
SMBJ60C	60	66.7	81.5	1	107	5.6	1	DH
SMBJ60CA	60	66.7	73.7	1	96.8	6.2	1	DK
SMBJ64C	64	71.1	86.9	1	114	5.3	1	DL
SMBJ64CA	64	71.1	78.6	1	103	5.8	1	DM
SMBJ70C	70	77.8	95.1	1	125	4.8	1	DN
SMBJ70CA	70	77.8	86.0	1	113	5.3	1	DP
SMBJ75C	75	83.3	102	1	134	4.5	1	DQ
SMBJ75CA	75	83.3	92.1	1	121	4.9	1	DR
SMBJ78C	78	86.7	106	1	139	4.3	1	DS
SMBJ78CA	78	86.7	95.8	1	126	4.7	1	DT
SMBJ85C	85	94.4	115	1	151	3.9	1	DU
SMBJ85CA	85	94.4	104	1	137	4.4	1	DV
SMBJ90C	90	100	122	1	160	3.8	1	DW
SMBJ90CA	90	100	111	1	146	4.1	1	DX
SMBJ100C	100	111	136	1	179	3.4	1	DY
SMBJ100CA	100	111	123	1	162	3.7	1	DZ
SMBJ110C	110	122	149	1	196	3.0	1	ED
SMBJ110CA	110	122	135	1	177	3.4	1	EE
SMBJ120C	120	133	163	1	214	2.8	1	EF
SMBJ120CA	120	133	147	1	193	3.1	1	EG
SMBJ130C	130	144	176	1	231	2.6	1	EH
SMBJ130CA	130	144	159	1	209	2.9	1	EK
SMBJ150C	150	167	204	1	268	2.2	1	EL

For parts without A, the VBR is +10%.

Electrical Characteristics @ 25°C Unless Otherwise Specified

MCC PART NUMBER	REVERSE STAND-OFF VOLTAGE V_{WM}	BREAKDOWN VOLTAGE $V_{(BR)} @ I_T$ (VOLTS)			MAXIMUM CLAMPING VOLTAGE@ I_{PP}	PEAK PULSE CURRENT I_{PP}	MAXIMUM REVERSE LEAKAGE @ V_{WM} I_D	MARKING CODE
	VOLTS	MIN	MAX	I_T (mA)	VOLTS	(AMPS)	(μ A)	
SMBJ150CA	150	167	185	1	243	2.5	1	EM
SMBJ160C	160	178	218	1	287	2.1	1	EN
SMBJ160CA	160	178	197	1	259	2.3	1	EP
SMBJ170C	170	189	231	1	304	2.0	1	EQ
SMBJ170CA	170	189	209	1	275	2.2	1	ER
SMBJ180CA	180	201	222	1	292	2.1	1	ET
SMBJ200CA	200	224	247	1	324	1.9	1	EV
SMBJ220CA	220	246	272	1	356	1.7	1	EX
SMBJ250CA	250	279	309	1	405	1.5	1	EZ
SMBJ300CA	300	335	371	1	486	1.3	1	FE
SMBJ350CA	350	391	432	1	567	1.1	1	FG
SMBJ400CA	400	447	494	1	648	0.9	1	FK
SMBJ440CA	440	492	543	1	713	0.9	1	FM

For parts without A, the VBR is +10%.

Curve Characteristics

Fig. 1 - Peak Pulse Power Rating Curve

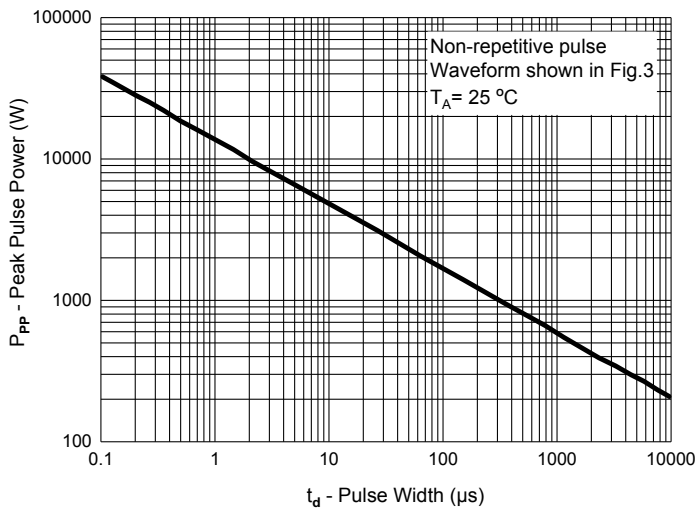

Fig. 2 - Typical Junction Capacitance

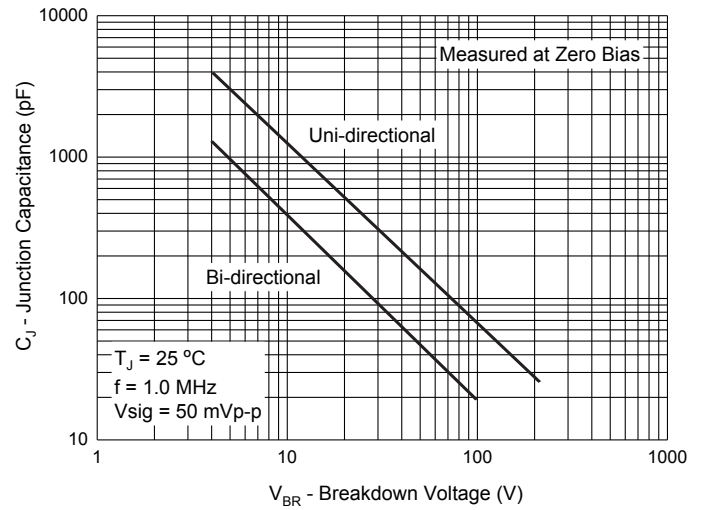

Fig. 3 - Pulse Waveform

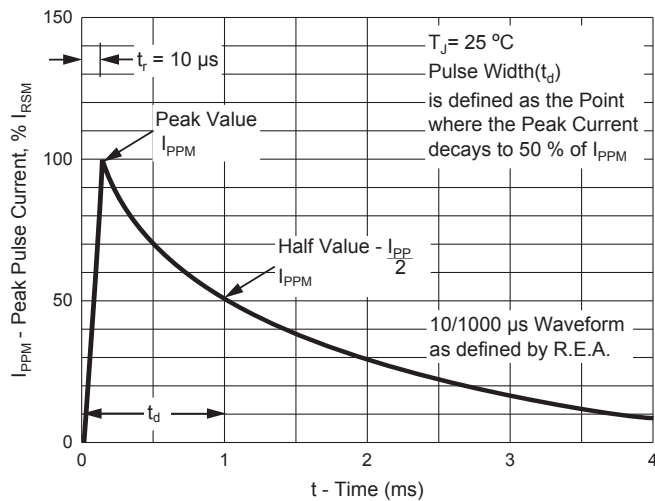

Fig. 4 - Pulse Derating Curve

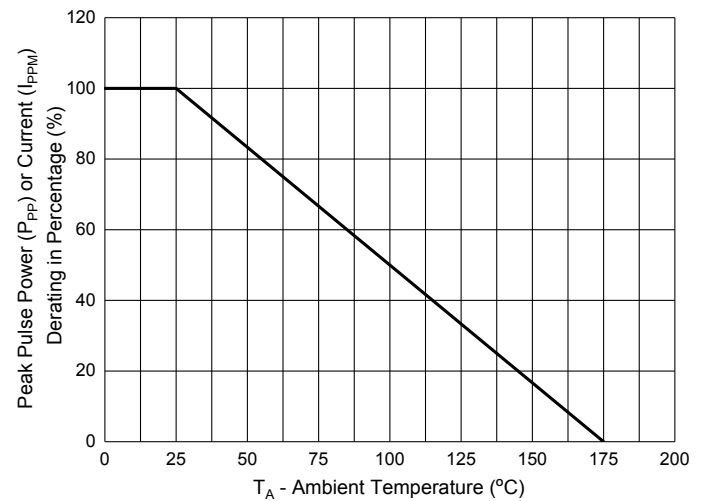

Fig. 5 - Maximum Non-Repetitive Peak Forward Surge Current

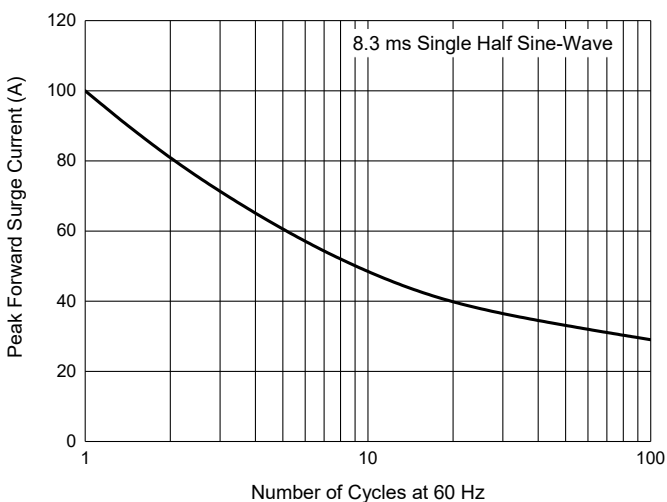
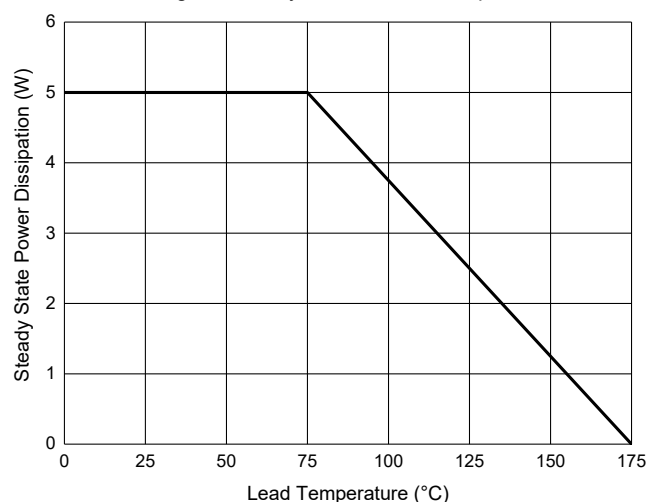

Fig. 6 - Steady State Power Dissipation



Ordering Information

Device	Packing
Part Number-TP	Tape&Reel:3Kpcs/Reel

*****IMPORTANT NOTICE*****

Micro Commercial Components Corp. reserves the right to make changes without further notice to any product herein to make corrections, modifications, enhancements, improvements, or other changes. **Micro Commercial Components Corp.** does not assume any liability arising out of the application or use of any product described herein; neither does it convey any license under its patent rights, nor the rights of others. The user of products in such applications shall assume all risks of such use and will agree to hold **Micro Commercial Components Corp.** and all the companies whose products are represented on our website, harmless against all damages. **Micro Commercial Components Corp.** products are sold subject to the general terms and conditions of commercial sale, as published at <https://www.mccsemi.com/Home/TermsAndConditions>.

*****LIFE SUPPORT*****

MCC's products are not authorized for use as critical components in life support devices or systems without the express written approval of Micro Commercial Components Corporation.

*****CUSTOMER AWARENESS*****

Counterfeiting of semiconductor parts is a growing problem in the industry. Micro Commercial Components (MCC) is taking strong measures to protect ourselves and our customers from the proliferation of counterfeit parts. MCC strongly encourages customers to purchase MCC parts either directly from MCC or from Authorized MCC Distributors who are listed by country on our web page cited below. Products customers buy either from MCC directly or from Authorized MCC Distributors are genuine parts, have full traceability, meet MCC's quality standards for handling and storage. **MCC will not provide any warranty coverage or other assistance for parts bought from Unauthorized Sources.** MCC is committed to combat this global problem and encourage our customers to do their part in stopping this practice by buying direct or from authorized distributors.

单击下面可查看定价，库存，交付和生命周期等信息

[>>MCC\(美微科\)](#)