

### Features

- For Surface Mount Applications in Order to Optimize Board Space
- Fast Response Time: Typical Less Than 1.0ps From 0 volts to  $V_B$  Minimum
- Low Inductance
- Halogen Free. "Green" Device (Note 1)
- Moisture Sensitivity Level 1
- Epoxy Meets UL 94 V-0 Flammability Rating
- Lead Free Finish/RoHS Compliant (Note 2) ("P" Suffix Designates Compliant. See Ordering Information)
- For Bidirectional Devices Add "C" To The Suffix of The Part Number: i.e.SMBJ220CAL for 5% Tolerance

### Mechanical Data

- Terminals: Solderable per MIL-STD-750, Method 2026
- Polarity: Color Band Denotes Positive End( Cathode) Except Bi-directional Types

### Maximum Ratings

- Operating Junction Temperature Range:  $-55^{\circ}\text{C}$  to  $+175^{\circ}\text{C}$
- Storage Temperature Range:  $-55^{\circ}\text{C}$  to  $+175^{\circ}\text{C}$
- Thermal Resistance :  $20^{\circ}\text{C}/\text{W}$  Junction to Lead
- Thermal Resistance :  $25^{\circ}\text{C}/\text{W}$  Junction to Case

### Electrical Characteristics @ $25^{\circ}\text{C}$ Unless Otherwise Specified

Peak Pulse Power Surge Current on 10/1000 $\mu\text{s}$ Waveform	$I_{PP}$	See the Table	Note 3
Peak Pulse Power Dissipation	$P_{PP}$	600W	Note 4,5
Steady State Power Dissipation	$P_{M(AV)}$	5.0W	Note 5

**NOTES:**

1. Halogen free "Green"products are defined as those which contain <900ppm bromine, <900ppm chlorine (<1500ppm total Br + Cl) and <1000ppm antimony compounds.
2. High Temperature Solder Exemption Applied, See EU Directive Annex 7a.
3. Non-repetitive Current Pulse, Per Fig.3 and Derated Above  $T_A=25^{\circ}\text{C}$  Per Fig.4.
4. Mounted on 5.0mm<sup>2</sup> Copper Pads to Each Terminal.
5. Power Dissipation, on Infinite Heat Sink at  $T_L=75^{\circ}\text{C}$ .

**Pin Configuration:**

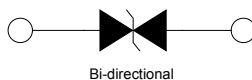
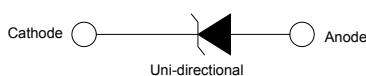

## 600 Watt TVS 220 to 440 Volts

### SMB (DO-214AA)

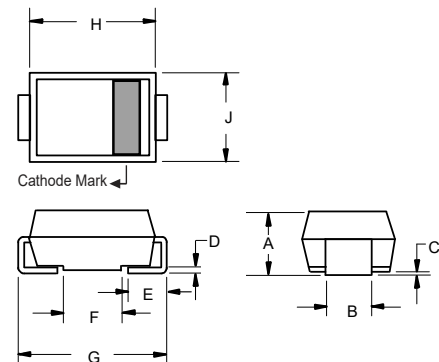

DIM	DIMENSIONS				NOTE
	INCHES		MM		
	MIN	MAX	MIN	MAX	
A	0.079	0.103	2.00	2.62	
B	0.075	0.087	1.91	2.21	
C	0.002	0.008	0.05	0.20	
D	0.006	0.012	0.15	0.31	
E	0.030	0.060	0.76	1.52	
F	0.065	0.091	1.65	2.32	
G	0.200	0.220	5.08	5.59	
H	0.160	0.191	4.06	4.85	
J	0.130	0.155	3.30	3.94	

**Suggested Solder Pad Layout**

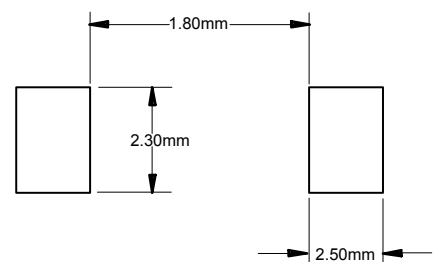

Electrical Characteristics @ 25°C Unless Otherwise Specified

MCC PART NUMBER		REVERSE STAND-OFF VOLTAGE $V_{WM}$	BREAKDOWN VOLTAGE $V_{(BR)} @ I_T$ (VOLTS)			MAXIMUM CLAMPING VOLTAGE @ $I_{PP}$	PEAK PULSE CURRENT $I_{PP}$	MAXIMUM REVERSE LEAKAGE @ $V_{WM}$ $I_D$	MARKING CODE	
			(VOLTS)	MIN	MAX				$I_T$ (mA)	(VOLTS)
UNI-POLAR	BI-POLAR	(VOLTS)	MIN	MAX	$I_T$ (mA)	(VOLTS)	(AMPS)	( $\mu$ A)	UNI	BI
SMBJ220AL	SMBJ220CAL	220	246	272	1	356	1.7	1	PXL	EXL
SMBJ250AL	SMBJ250CAL	250	279	309	1	405	1.5	1	PZL	EZL
SMBJ300AL	SMBJ300CAL	300	335	371	1	486	1.3	1	QEL	FEL
SMBJ350AL	SMBJ350CAL	350	391	432	1	567	1.1	1	QGL	FGL
SMBJ400AL	SMBJ400CAL	400	447	494	1	648	0.9	1	QKL	FKL
SMBJ440AL	SMBJ440CAL	440	492	543	1	713	0.9	1	QML	FML

Curve Characteristics

Fig. 1 - Peak Pulse Power Rating Curve

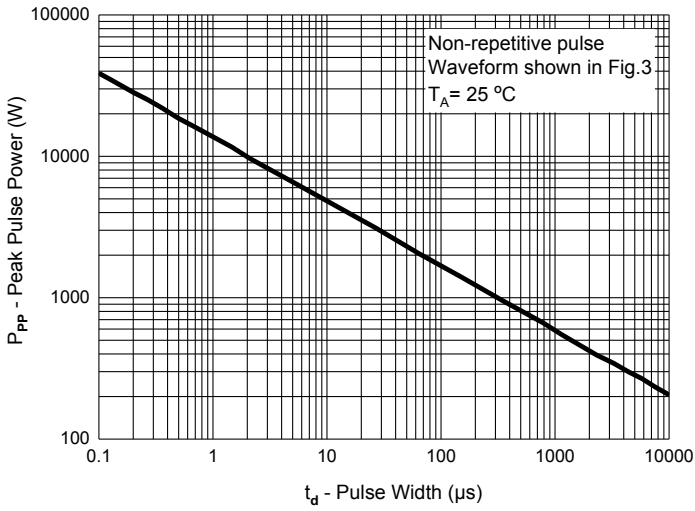

Fig. 2 - Typical Junction Capacitance

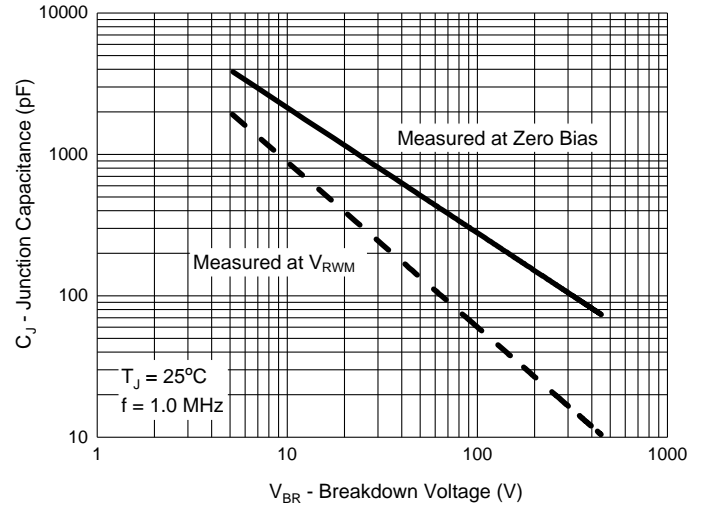

Fig. 3 - Pulse Waveform

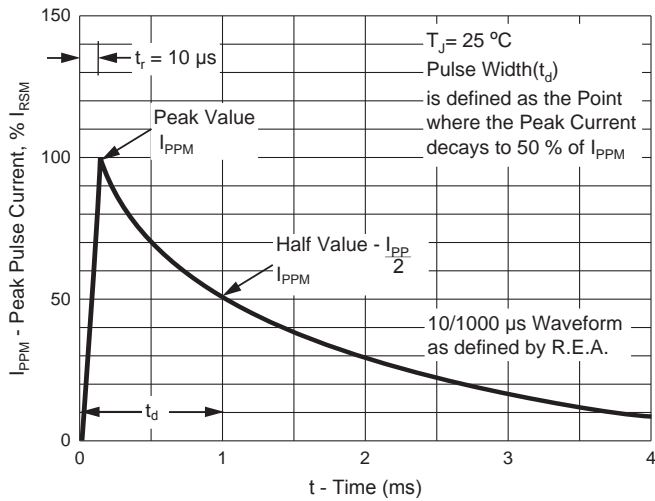
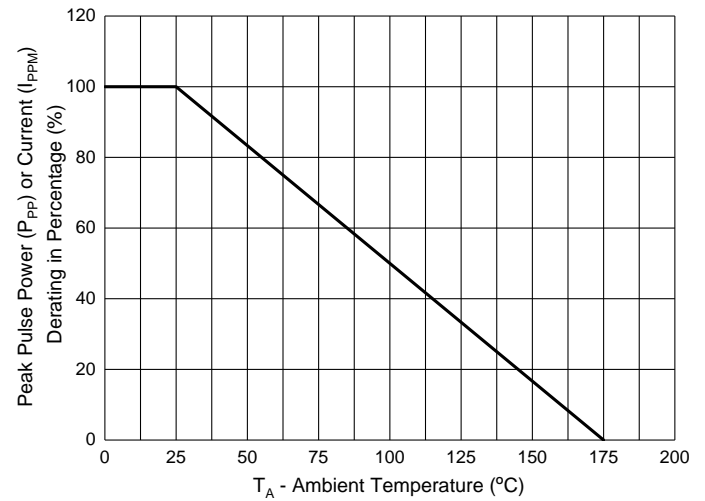

Fig. 4 - Pulse Derating Curve



## Ordering Information

Device	Packing
Part Number-TP	Tape&Reel:3Kpcs/Reel

### \*\*\*IMPORTANT NOTICE\*\*\*

**Micro Commercial Components Corp.** reserves the right to make changes without further notice to any product herein to make corrections, modifications, enhancements, improvements, or other changes. **Micro Commercial Components Corp.** does not assume any liability arising out of the application or use of any product described herein; neither does it convey any license under its patent rights, nor the rights of others. The user of products in such applications shall assume all risks of such use and will agree to hold **Micro Commercial Components Corp.** and all the companies whose products are represented on our website, harmless against all damages. **Micro Commercial Components Corp.** products are sold subject to the general terms and conditions of commercial sale, as published at <https://www.mccsemi.com/Home/TermsAndConditions>.

### \*\*\*LIFE SUPPORT\*\*\*

MCC's products are not authorized for use as critical components in life support devices or systems without the express written approval of Micro Commercial Components Corporation.

### \*\*\*CUSTOMER AWARENESS\*\*\*

Counterfeiting of semiconductor parts is a growing problem in the industry. Micro Commercial Components (MCC) is taking strong measures to protect ourselves and our customers from the proliferation of counterfeit parts. MCC strongly encourages customers to purchase MCC parts either directly from MCC or from Authorized MCC Distributors who are listed by country on our web page cited below. Products customers buy either from MCC directly or from Authorized MCC Distributors are genuine parts, have full traceability, meet MCC's quality standards for handling and storage. **MCC will not provide any warranty coverage or other assistance for parts bought from Unauthorized Sources.** MCC is committed to combat this global problem and encourage our customers to do their part in stopping this practice by buying direct or from authorized distributors.

单击下面可查看定价，库存，交付和生命周期等信息

[>>MCC\(美微科\)](#)