



# SL32B THRU SL310B

Reverse Voltage - 20 to 100 Volts Forward Current - 3.0 Ampere

## LOW FORWARD VOLTAGE SCHOTTKY BARRIER DIODES

### Features

- ◆ The plastic package carries Underwriters Laboratory Flammability Classification 94V-0
- ◆ For surface mounted applications
- ◆ Metal silicon junction, majority carrier conduction
- ◆ Low power loss, high efficiency
- ◆ Built-in strain relief, ideal for automated placement
- ◆ High forward surge current capability
- ◆ High temperature soldering guaranteed:  
260°C/10 seconds at terminals

### Mechanical Data

**Case** : JEDEC DO-214AA/SMB Molded plastic body  
**Terminals** : Solder plated, solderable per MIL-STD-750, Method 2026  
**Polarity** : Polarity symbol marking on body  
**Mounting Position** : Any  
**Weight** : 0.003ounce, 0.093 grams

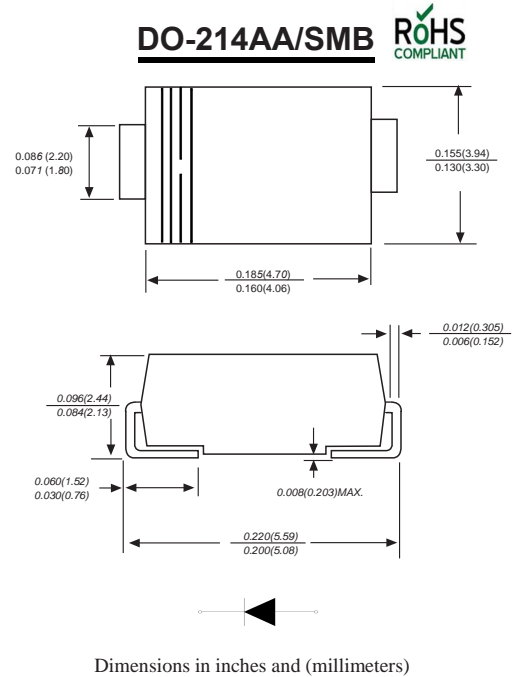

### Maximum Ratings And Electrical Characteristics

Ratings at 25°C ambient temperature unless otherwise specified.

Single phase half-wave 60Hz, resistive or inductive load, for capacitive load current derate by 20%.

Parameter	SYMBOLS	SL32B	SL33B	SL34B	SL35B	SL36B	SL38B	SL310B	UNITS
		MDD SL32B	MDD SL33B	MDD SL34B	MDD SL35B	MDD SL36B	MDD SL38B	MDD SL310B	
Maximum repetitive peak reverse voltage	$V_{RMM}$	20	30	40	50	60	80	100	V
Maximum RMS voltage	$V_{RMS}$	14	21	28	35	42	56	70	V
Maximum DC blocking voltage	$V_{DC}$	20	30	40	50	60	80	100	V
Maximum average forward rectified current at $T_L=90^\circ\text{C}$	$I_{(AV)}$	3.0							A
Peak forward surge current 8.3ms single half sine-wave superimposed on rated load (JEDEC Method)	$I_{FSM}$	70							A
Maximum instantaneous forward voltage at 3.0A	$V_F$	0.45		0.50		0.70		V	
Maximum DC reverse current $T_A=25^\circ\text{C}$ at rated DC blocking voltage $T_A=125^\circ\text{C}$	$I_R$	0.5 20.0			0.2 10.0		mA		
Typical junction capacitance (NOTE 2)	$C_J$	500			300			pF	
Typical thermal resistance (NOTE 3)	$R_{\theta JA}$	68.0							$^\circ\text{C}/\text{W}$
Operating junction and storage temperature range	$T_J, T_{STG}$	-55 to +150							$^\circ\text{C}$

- Note:** 1. Measured at 1MHz and applied reverse voltage of 4.0V D.C.  
 2. P.C.B. mounted with 2.0x2.0" (5.0x5.0cm) copper pad areas.  
 3. The typical data above is for reference only.



# SL32B THRU SL310B

Reverse Voltage - 20 to 100 Volts Forward Current - 3.0 Ampere

## Ratings And Characteristic Curves

AVERAGE FORWARD RECTIFIED CURRENT, AMPERES

FIG. 1- FORWARD CURRENT DERATING CURVE

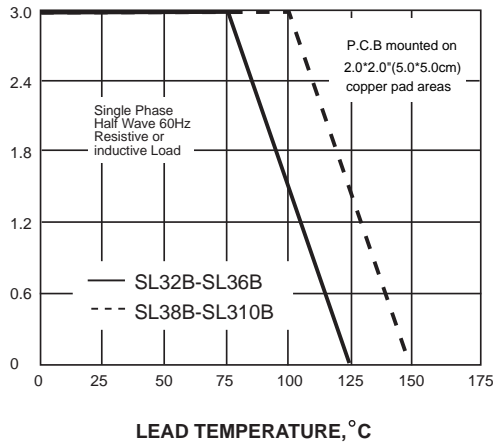

PEAK FORWARD SURGE CURRENT, AMPERES

FIG. 2-MAXIMUM NON-REPETITIVE PEAK FORWARD SURGE CURRENT

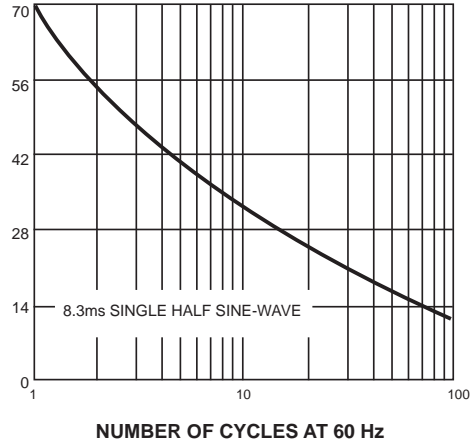

FIG. 3-TYPICAL INSTANTANEOUS FORWARD CHARACTERISTICS

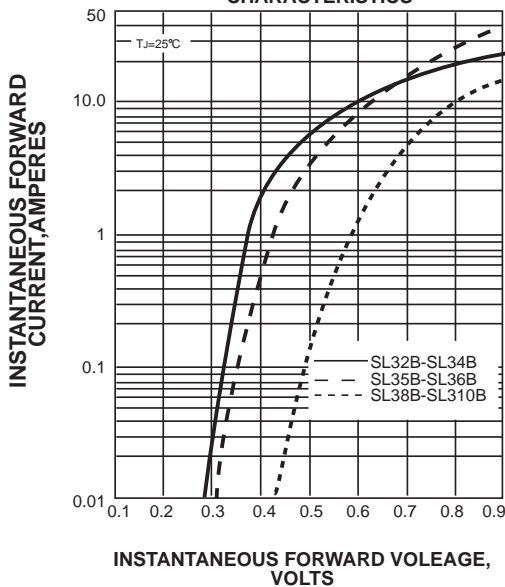

FIG. 4-TYPICAL REVERSE CHARACTERISTICS

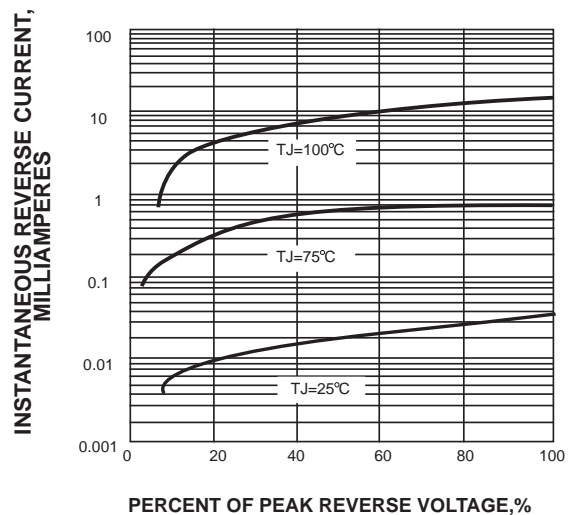

FIG. 5-TYPICAL JUNCTION CAPACITANCE

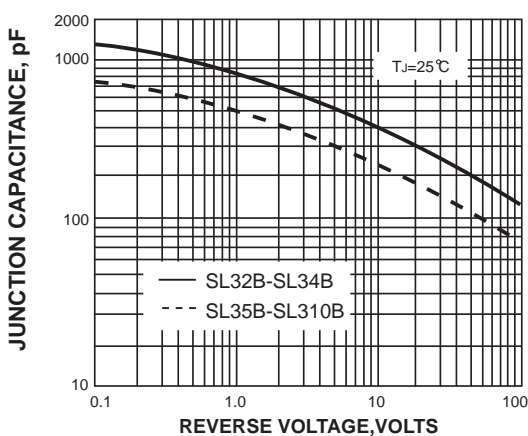
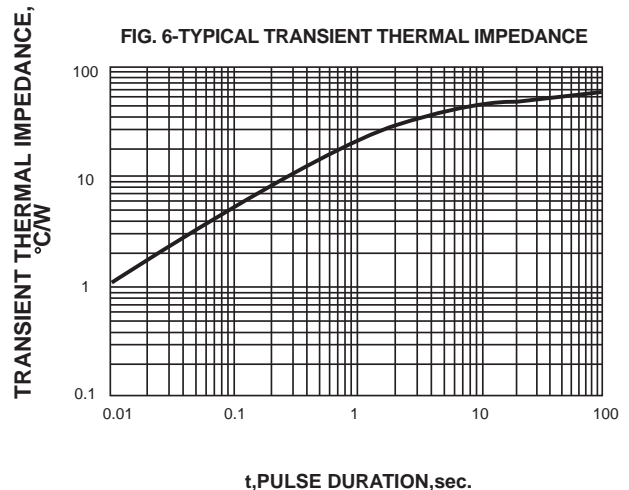

FIG. 6-TYPICAL TRANSIENT THERMAL IMPEDANCE



The curve above is for reference only.



# SL32B THRU SL310B

Reverse Voltage - 20 to 100 Volts Forward Current - 3.0 Ampere

## Packing information

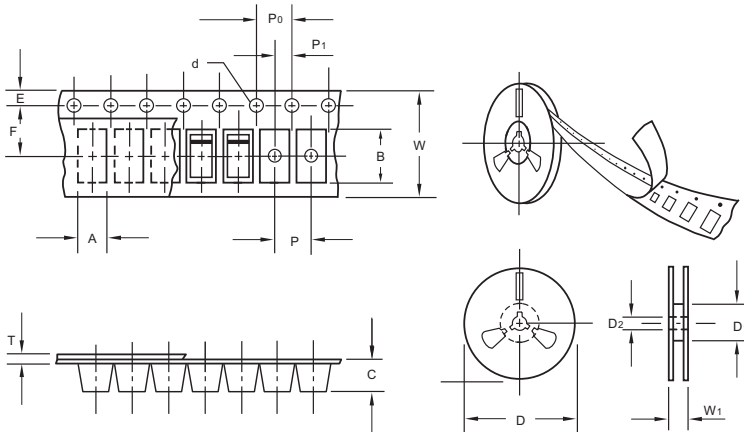

unit:mm

Item	Symbol	Tolerance	SMB
Carrier width	A	0.1	3.81
Carrier length	B	0.1	5.41
Carrier depth	C	0.1	2.42
Sprocket hole	d	0.05	1 5.0
13" Reel outside diameter	D	2.0	330.00
13" Reel inner diameter	D <sub>1</sub>	min	50.00
Feed hole diameter	D <sub>2</sub>	0.5	13.00
Sprocket hole position	E	0.1	1.75
Punch hole position	F	0.1	5.55
Punch hole pitch	P	0.1	8.00
Sprocket hole pitch	P <sub>0</sub>	0.1	4.00
Embossment center	P <sub>1</sub>	0.1	2.00
Overall tape thickness	T	0.1	0.30
Tape width	W	0.3	12.00
Reel width	W <sub>1</sub>	1.0	12.30

Note: Devices are packed in accordance with EIA standard RS-481-A and specifications listed above.

## Reel packing

PACKAGE	REEL SIZE	REEL (pcs)	COMPONENT SPACING (mm)	BOX (pcs)	INNER BOX (mm)	REEL DIA, (mm)	CARTON SIZE (mm)	CARTON (pcs)	APPROX. GROSS WEIGHT (kg)
SMB	13"	3,000	4.0	10,000	190*190*41	330	365*365*360	80,000	14.0

## Suggested Pad Layout



Symbol	Unit (mm)	Unit (inch)
A	2.8	0.110
B	2.4	0.094
C	4.6	0.181
D	2.2	0.086
E	7.0	0.276

## Important Notice and Disclaimer

Microdiode Electronics (Jiangsu) reserves the right to make changes to this document and its products and specifications at any time without notice. Customers should obtain and confirm the latest product information and specifications before final design, purchase or use.

Microdiode Electronics (Jiangsu) makes no warranty, representation or guarantee regarding the suitability of its products for any particular purpose, nor does Microdiode Electronics (Jiangsu) assume any liability for application assistance or customer product design. Microdiode Electronics (Jiangsu) does not warrant or accept any liability with products which are purchased or used for any unintended or unauthorized application.

No license is granted by implication or otherwise under any intellectual property rights of Microdiode Electronics (Jiangsu).

Microdiode Electronics (Jiangsu) products are not authorized for use as critical components in life support devices or systems without express written approval of Microdiode Electronics (Jiangsu).

单击下面可查看定价，库存，交付和生命周期等信息

[>>MDD\(辰达行\)](#)