

Low-Voltage Input Boost Regulator for PIC[®] Microcontrollers

Features

- Up to 96% Typical Efficiency
- 425 mA Typical Peak Input Current Limit:
 - $I_{OUT} > 50 \text{ mA}$ @ 1.2V V_{IN} , 3.3V V_{OUT}
 - $I_{OUT} > 175 \text{ mA}$ @ 2.4V V_{IN} , 3.3V V_{OUT}
 - $I_{OUT} > 175 \text{ mA}$ @ 3.3V V_{IN} , 5.0V V_{OUT}
- Low Start-Up Voltage: 0.65V, 3.3V V_{OUT} @ 1 mA (typical)
- Low Operating Input Voltage: 0.35V, typical 3.3V V_{OUT} @ 1 mA
- Adjustable Output Voltage Range: 2.0V to 5.5V
- Maximum Input Voltage $\leq V_{OUT} < 5.5\text{V}$
- Automatic PFM/PWM Operation (MCP1624)
- PWM-Only Operation (MCP1623)
- PWM Operation: 500 kHz
- Low Device Quiescent Current: 19 μA , typical PFM Mode
- Internal Synchronous Rectifier
- Internal Compensation
- Inrush Current Limiting and Internal Soft Start
- True Load Disconnect
- Shutdown Current (All States): $< 1 \mu\text{A}$
- Low Noise, Anti-Ringing Control
- Overtemperature Protection
- Available Packages:
 - 6-Lead SOT-23
 - 8-Lead 2 x 3 DFN

Applications

- One, Two and Three-Cell Alkaline and NiMH/NiCd Low-Power PIC[®] Microcontroller Applications

General Description

The MCP1623/24 is a compact, high-efficiency, fixed-frequency, synchronous step-up DC-DC converter. It provides an easy-to-use power supply solution for PIC[®] microcontroller applications powered by either single-cell, two-cell, or three-cell alkaline, NiCd, NiMH, and single-cell Li-Ion or Li-Polymer batteries.

Low-voltage technology allows the regulator to start up without high inrush current or output voltage overshoot from a low 0.65V input. High efficiency is accomplished by integrating the low-resistance N-Channel Boost switch and synchronous P-Channel switch. All compensation and protection circuitry are integrated to minimize external components. For standby applications, the MCP1624 operates and consumes only 19 μA while operating at no load.

A "true" Load Disconnect mode provides input to output isolation while disabled ($\text{EN} = \text{GND}$) by removing the normal boost regulator diode path from input to output. This mode consumes less than 1 μA of input current.

Output voltage is set by a small external resistor divider.

Package Types

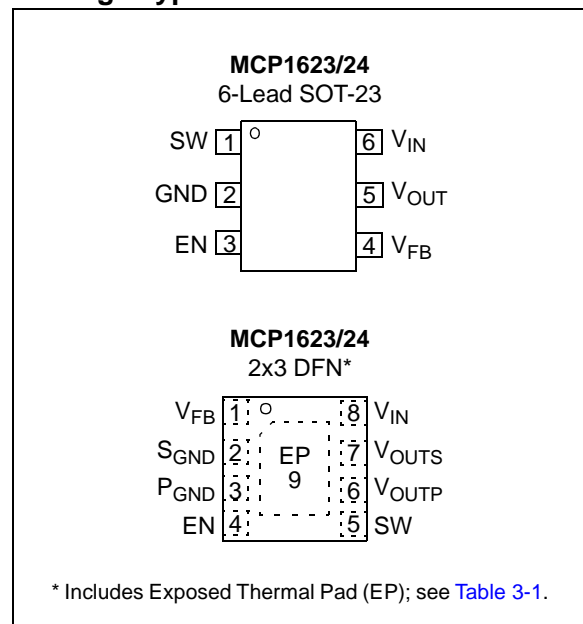

MCP1623/24

Typical Application

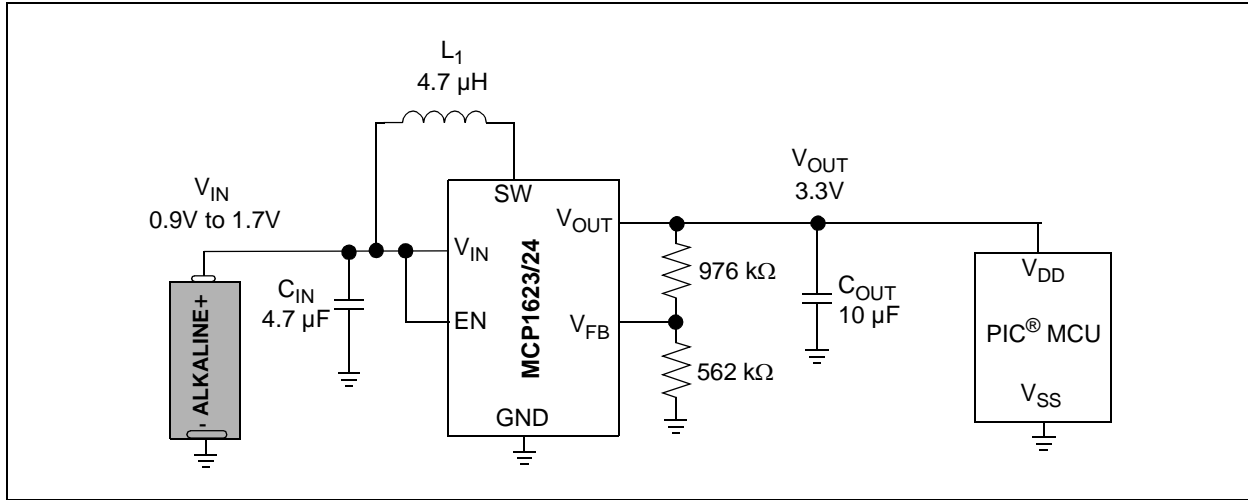

FIGURE 1: Typical Application Circuit.

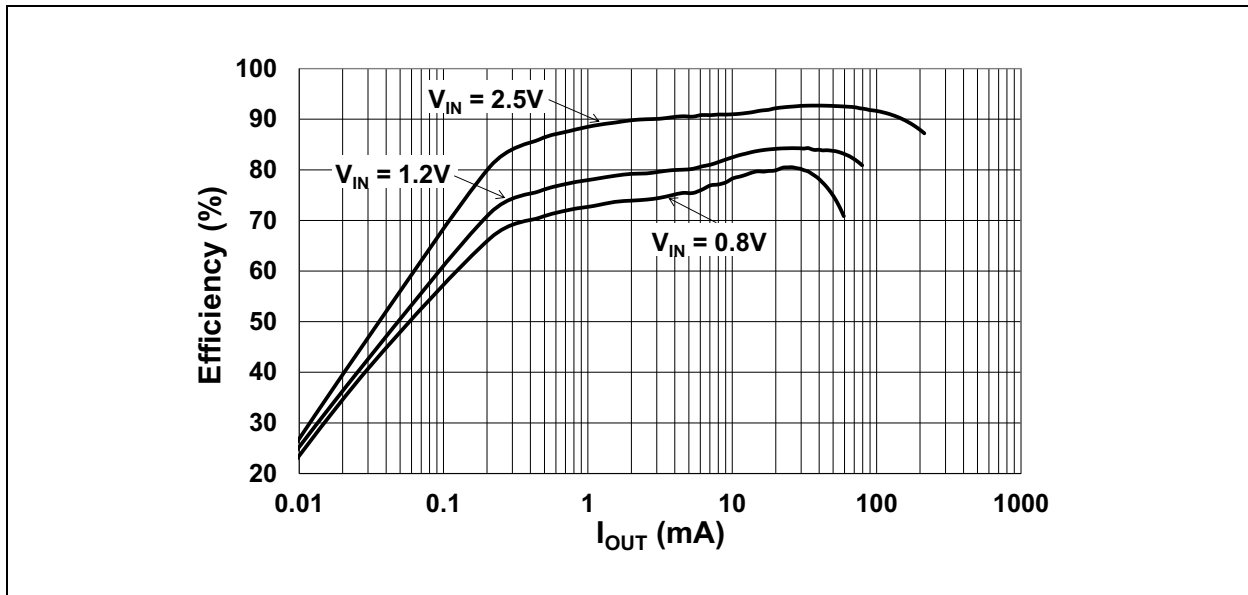

FIGURE 2: MCP1624 Efficiency vs. I_{OUT} , $V_{OUT} = 3.3V$.

1.0 ELECTRICAL CHARACTERISTICS

Absolute Maximum Ratings †

EN, FB, V_{IN} , V_{SW} , $V_{OUT} - GND$	+6.5V
EN, FB	<maximum of V_{OUT} or V_{IN} > (GND – 0.3V)
Output Short-Circuit Current	Continuous
Power Dissipation	Internally Limited
Storage Temperature	-65°C to +150°C
Ambient Temperature with Power Applied	-40°C to +85°C
Operating Junction Temperature.....	-40°C to +125°C
ESD Protection on All Pins:	
HBM.....	3 kV
MM.....	300V

† **Notice:** Stresses above those listed under "Maximum Ratings" may cause permanent damage to the device. This is a stress rating only and functional operation of the device at those or any other conditions above those indicated in the operational sections of this specification is not intended. Exposure to maximum rating conditions for extended periods may affect device reliability.

DC CHARACTERISTICS

Electrical Characteristics: Unless otherwise indicated, $V_{IN} = 1.2V$, $C_{OUT} = C_{IN} = 10 \mu F$, $L = 4.7 \mu H$, $V_{OUT} = 3.3V$, $I_{OUT} = 15 \text{ mA}$, $T_A = +25^\circ C$.

Boldface specifications apply over the T_A range of -40°C to +85°C.

Parameters	Sym.	Min.	Typ.	Max.	Units	Conditions
Input Characteristics						
Minimum Start-Up Voltage	V_{IN}	—	0.65	0.8	V	Note 1
Minimum Input Voltage after Start-Up	V_{IN}	—	0.35	—	V	Note 1
Output Voltage Adjust Range	V_{OUT}	2.0	—	5.5	V	$V_{OUT} \geq V_{IN}$ (Note 2)
Maximum Output Current	I_{OUT}	50	—	—	mA	1.5V V_{IN} , 3.3V V_{OUT}
Feedback Voltage	V_{FB}	1.120	1.21	1.299	V	
Feedback Input Bias Current	I_{VFB}	—	10	—	pA	
Quiescent Current – PFM mode	I_{QPFM}	—	19	30	μA	Measured at $V_{OUT} = 4.0V$; $EN = V_{IN}$, $I_{OUT} = 0 \text{ mA}$ (Note 3)
Quiescent Current – PWM mode	I_{QPWM}	—	220	—	μA	Measured at V_{OUT} ; $EN = V_{IN}$ $I_{OUT} = 0 \text{ mA}$ (Note 3)
Quiescent Current – Shutdown	I_{QSHDN}	—	0.7	2.3	μA	$V_{OUT} = EN = GND$; Includes N-Channel and P-Channel switch leakage
NMOS Switch Leakage	I_{NLK}	—	0.3	—	μA	$V_{IN} = V_{SW} = 5V$; $V_{OUT} = 5.5V$ $V_{EN} = V_{FB} = GND$
PMOS Switch Leakage	I_{PLK}	—	0.05	—	μA	$V_{IN} = V_{SW} = GND$; $V_{OUT} = 5.5V$
NMOS Switch ON Resistance	$R_{DS(ON)N}$	—	0.6	—	Ω	$V_{IN} = 3.3V$, $I_{SW} = 100 \text{ mA}$

Note 1: 3.3 k Ω resistive load, 3.3 V_{OUT} (1 mA).

2: For $V_{IN} > V_{OUT}$, V_{OUT} will not remain in regulation.

3: I_Q is measured from V_{OUT} ; V_{IN} quiescent current will vary with boost ratio. V_{IN} quiescent current can be estimated by: ($I_{QPFM} * (V_{OUT}/V_{IN})$), ($I_{QPWM} * (V_{OUT}/V_{IN})$).

4: Peak current limit determined by characterization, not production tested

5: 220 Ω resistive load, 3.3 V_{OUT} (15 mA).

MCP1623/24

DC CHARACTERISTICS (CONTINUED)

Electrical Characteristics: Unless otherwise indicated, $V_{IN} = 1.2V$, $C_{OUT} = C_{IN} = 10 \mu F$, $L = 4.7 \mu H$, $V_{OUT} = 3.3V$, $I_{OUT} = 15 mA$, $T_A = +25^\circ C$.
Boldface specifications apply over the T_A range of $-40^\circ C$ to $+85^\circ C$.

Parameters	Sym.	Min.	Typ.	Max.	Units	Conditions
PMOS Switch ON Resistance	$R_{DS(ON)P}$	—	0.9	—	Ω	$V_{IN} = 3.3V$, $I_{SW} = 100 mA$
NMOS Peak Switch Current Limit	$I_{N(MAX)}$	300	425	—	mA	Note 4
V_{OUT} Accuracy	$V_{OUT}\%$	-7.4	—	+7.4	%	Includes line and load regulation; $V_{IN} = 1.5V$, $I_{OUT} = 50 mA$
Line Regulation	$ \frac{\Delta V_{OUT}}{V_{OUT}} / \frac{\Delta V_{IN}}{V_{IN}} $	—	0.01	—	%/V	$V_{IN} = 1.5V$ to $3V$ $I_{OUT} = 25 mA$
Load Regulation	$ \frac{\Delta V_{OUT}}{V_{OUT}} $	—	0.01	—	%	$I_{OUT} = 25 mA$ to $50 mA$; $V_{IN} = 1.5V$
Maximum Duty Cycle	DC_{MAX}	—	90	—	%	
Switching Frequency	f_{SW}	370	500	630	kHz	
EN Input Logic High	V_{IH}	90	—	—	% of V_{IN}	$I_{OUT} = 1 mA$
EN Input Logic Low	V_{IL}	—	—	20	% of V_{IN}	$I_{OUT} = 1 mA$
EN Input Leakage Current	I_{ENLK}	—	0.005	—	μA	$V_{EN} = 5V$
Soft Start Time	t_{SS}	—	750	—	μS	EN Low-to-High, 90% of V_{OUT} (Note 5)
Thermal Shutdown Die Temperature	T_{SD}	—	150	—	$^\circ C$	
Die Temperature Hysteresis	T_{SDHYS}	—	10	—	$^\circ C$	

Note 1: 3.3 k Ω resistive load, 3.3V $_{OUT}$ (1 mA).

2: For $V_{IN} > V_{OUT}$, V_{OUT} will not remain in regulation.

3: I_Q is measured from V_{OUT} ; V_{IN} quiescent current will vary with boost ratio. V_{IN} quiescent current can be estimated by: $(I_{QPWM} * (V_{OUT}/V_{IN}))$, $(I_{QPWM} * (V_{OUT}/V_{IN}))$.

4: Peak current limit determined by characterization, not production tested

5: 220 Ω resistive load, 3.3V $_{OUT}$ (15 mA).

TEMPERATURE SPECIFICATIONS

Electrical Specifications: Unless otherwise indicated, $V_{IN} = 1.2V$, $C_{OUT} = C_{IN} = 10 \mu F$, $L = 4.7 \mu H$, $V_{OUT} = 3.3V$, $I_{OUT} = 15 mA$, $T_A = +25^\circ C$.
Boldface specifications apply over the T_A range of $-40^\circ C$ to $+85^\circ C$.

Parameters	Sym.	Min.	Typ.	Max.	Units	Conditions
Temperature Ranges						
Operating Junction Temperature Range	T_J	-40	—	+125	$^\circ C$	Steady state
Storage Temperature Range	T_A	-65	—	+150	$^\circ C$	
Maximum Junction Temperature	T_J	—	—	+150	$^\circ C$	Transient
Package Thermal Resistance						
Thermal Resistance, 6LD-SOT-23	θ_{JA}	—	190.5	—	$^\circ C/W$	
Thermal Resistance, 8LD-2x3 DFN	θ_{JA}	—	75	—	$^\circ C/W$	

2.0 TYPICAL PERFORMANCE CURVES

Note: The graphs and tables provided following this note are a statistical summary based on a limited number of samples and are provided for informational purposes only. The performance characteristics listed herein are not tested or guaranteed. In some graphs or tables, the data presented may be outside the specified operating range (e.g., outside specified power supply range) and therefore outside the warranted range.

Note: Unless otherwise indicated, $V_{IN} = EN = 1.2V$, $C_{OUT} = C_{IN} = 10 \mu F$, $L = 4.7 \mu H$, $V_{OUT} = 3.3V$, $I_{LOAD} = 15 mA$, $T_A = +25^\circ C$.

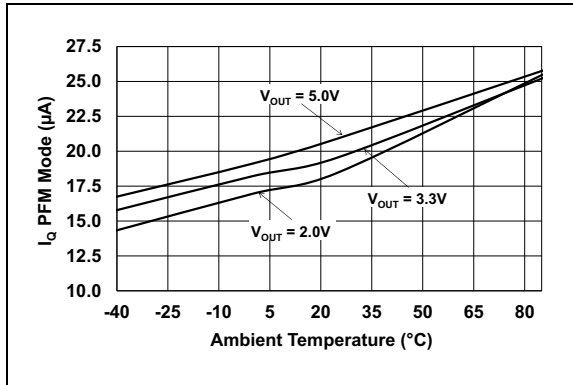

FIGURE 2-1: MCP1624 V_{OUT} I_Q vs. Ambient Temperature in PFM Mode, $V_{IN} = 1.2V$.

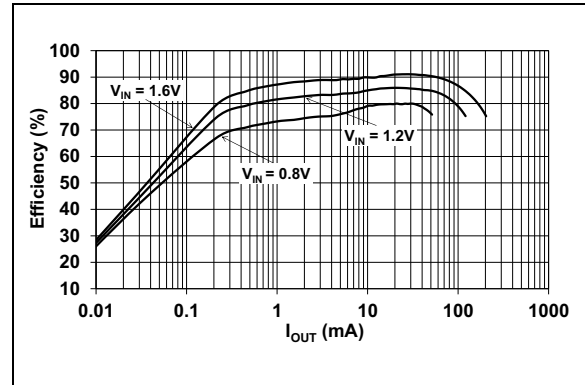

FIGURE 2-4: MCP1624 Efficiency vs. I_{OUT} , $V_{OUT} = 2.0V$.

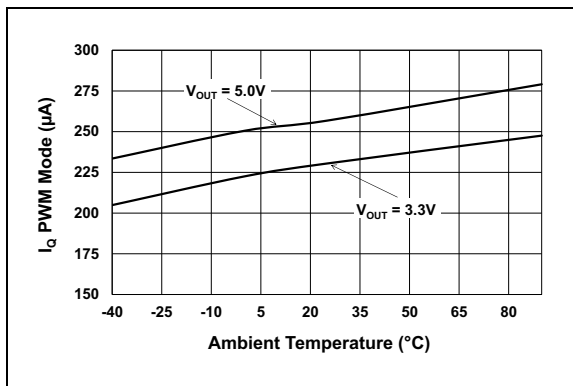

FIGURE 2-2: MCP1623 V_{OUT} I_Q vs. Ambient Temperature in PWM Mode, $V_{IN} = 1.2V$.

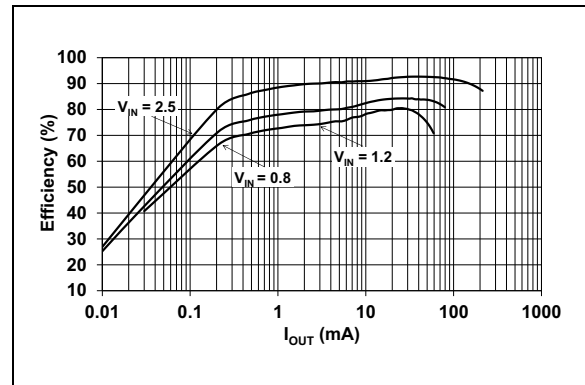

FIGURE 2-5: MCP1624 Efficiency vs. I_{OUT} , $V_{OUT} = 3.3V$.

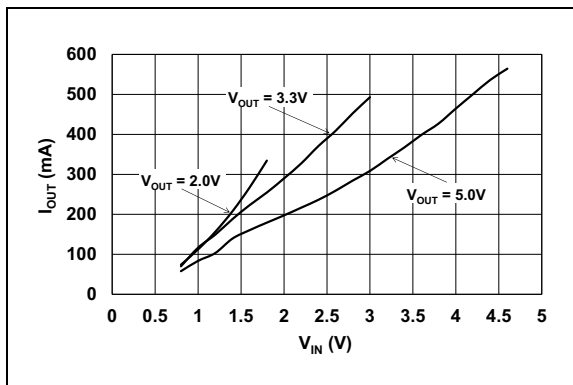

FIGURE 2-3: I_{OUTMAX} vs. V_{OUT} .

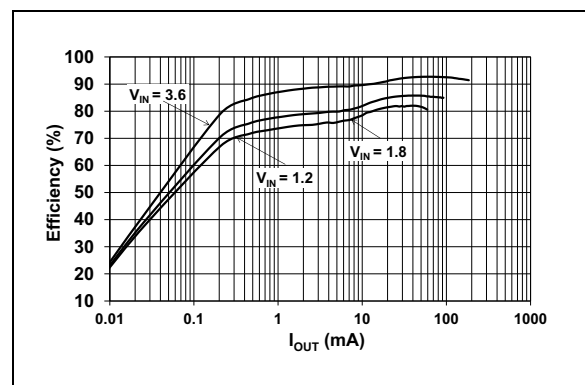

FIGURE 2-6: MCP1624 Efficiency vs. I_{OUT} , $V_{OUT} = 5.0V$.

MCP1623/24

Note: Unless otherwise indicated, $V_{IN} = EN = 1.2V$, $C_{OUT} = C_{IN} = 10 \mu F$, $L = 4.7 \mu H$, $V_{OUT} = 3.3V$, $I_{LOAD} = 15 mA$, $T_A = +25^\circ C$.

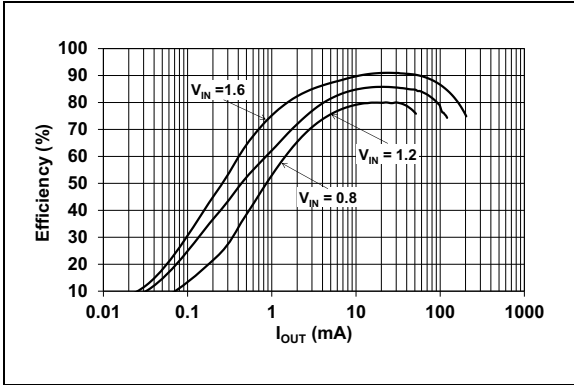

FIGURE 2-7: MCP1623 Efficiency vs. I_{OUT} , $V_{OUT} = 2.0V$.

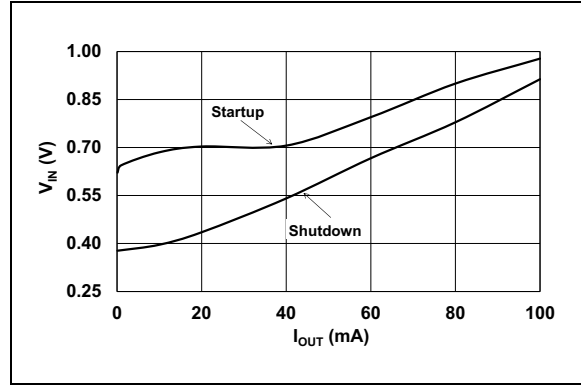

FIGURE 2-10: Minimum Start-Up and Shutdown V_{IN} into Resistive Load vs. I_{OUT} , $V_{OUT} = 3.3V$.

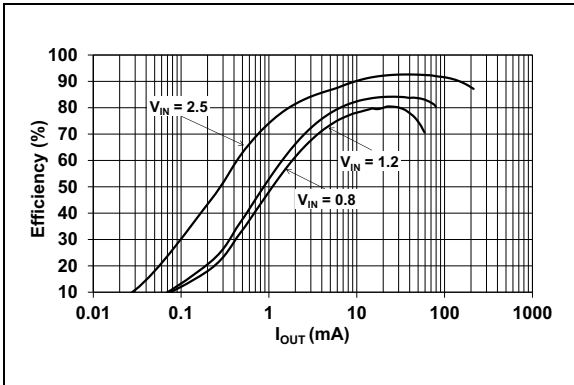

FIGURE 2-8: MCP1623 Efficiency vs. I_{OUT} , $V_{OUT} = 3.3V$.

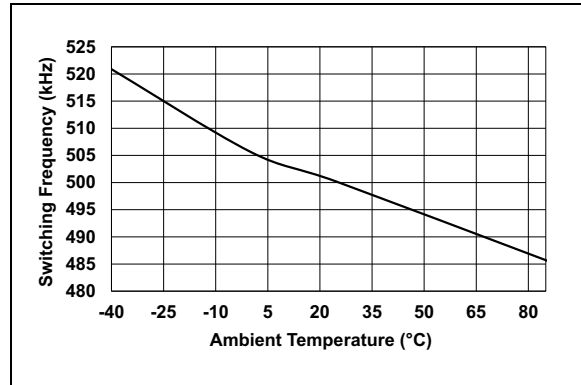

FIGURE 2-11: F_{OSC} vs. Ambient Temperature, $V_{OUT} = 3.3V$.

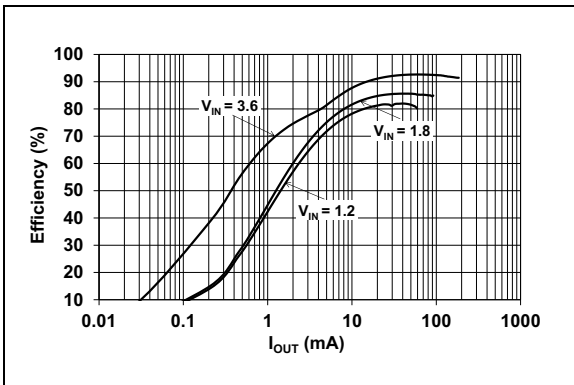

FIGURE 2-9: MCP1623 Efficiency vs. I_{OUT} , $V_{OUT} = 5.0V$.

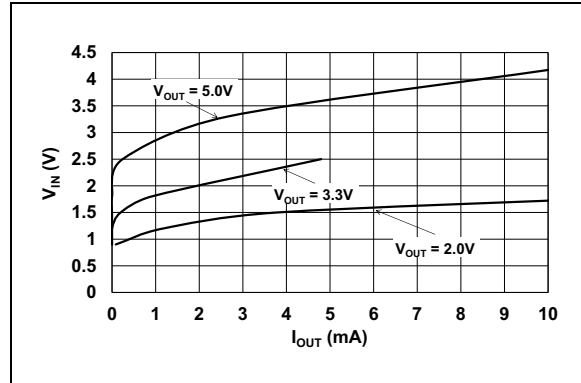

FIGURE 2-12: MCP1623 PWM Pulse Skipping Mode Threshold vs. I_{OUT} .

Note: Unless otherwise indicated, $V_{IN} = EN = 1.2V$, $C_{OUT} = C_{IN} = 10 \mu F$, $L = 4.7 \mu H$, $V_{OUT} = 3.3V$, $I_{LOAD} = 15 mA$, $T_A = +25^\circ C$.

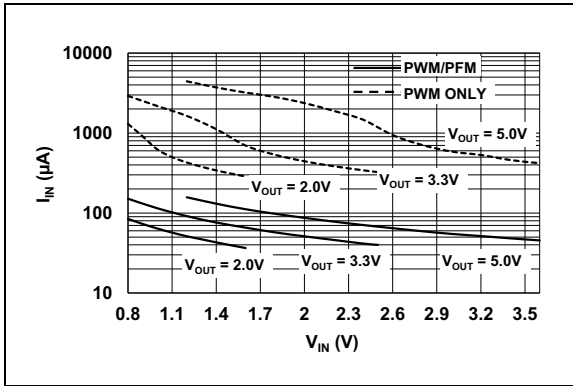

FIGURE 2-13: Input No Load Current vs. V_{IN} .

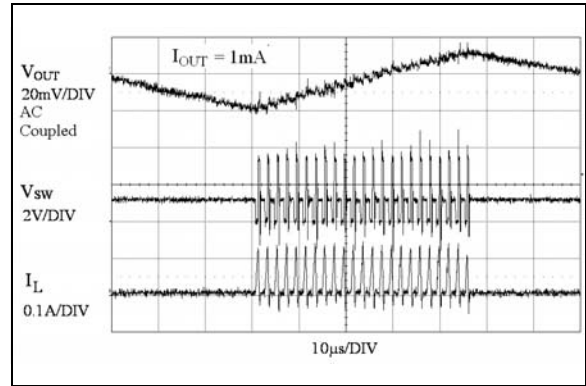

FIGURE 2-16: MCP1624 3.3V V_{OUT} PFM Mode Waveforms.

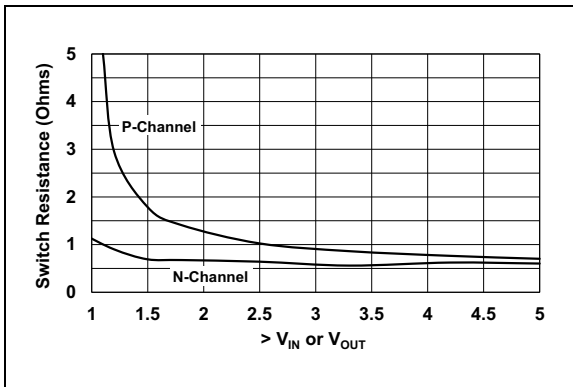

FIGURE 2-14: N-Channel and P-Channel $R_{DS(on)}$ vs. $> V_{IN}$ or V_{OUT} .

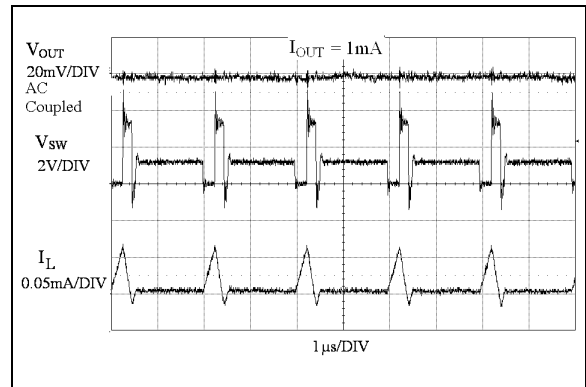

FIGURE 2-17: MCP1623 3.3V V_{OUT} PWM Mode Waveforms.

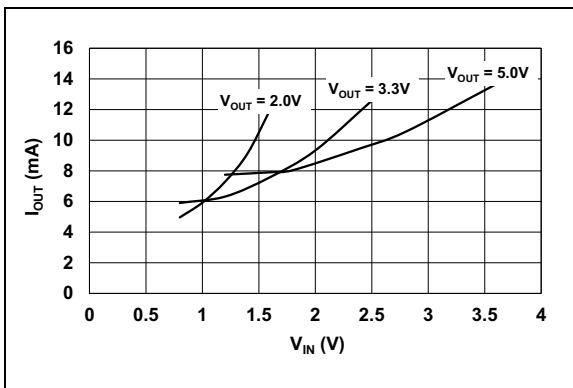

FIGURE 2-15: MCP1624 PFM/PWM Threshold Current vs. V_{IN} .

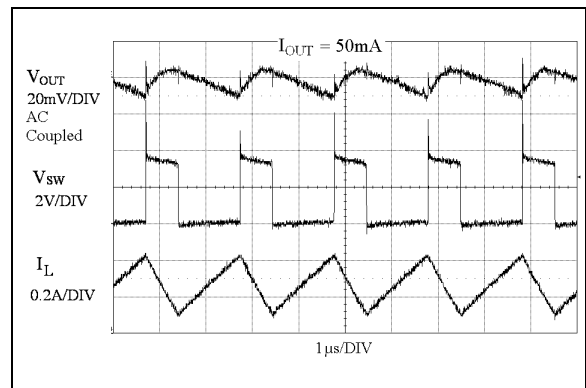

FIGURE 2-18: High Load Waveforms.

MCP1623/24

Note: Unless otherwise indicated, $V_{IN} = EN = 1.2V$, $C_{OUT} = C_{IN} = 10 \mu F$, $L = 4.7 \mu H$, $V_{OUT} = 3.3V$, $I_{LOAD} = 15 mA$, $T_A = +25^\circ C$.

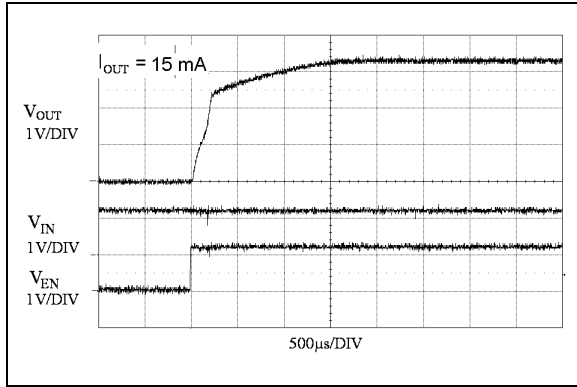

FIGURE 2-19: 3.3V Start-Up after Enable.

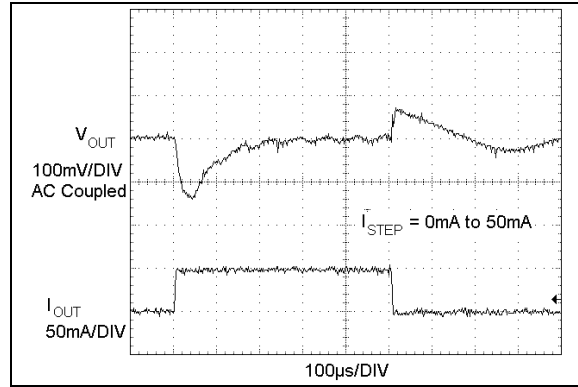

FIGURE 2-22: MCP1623 3.3V V_{OUT} Load Transient Waveforms.

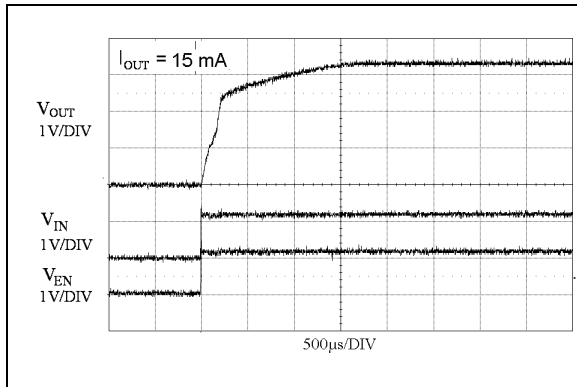

FIGURE 2-20: 3.3V Start-Up when $V_{IN} = V_{ENABLE}$.

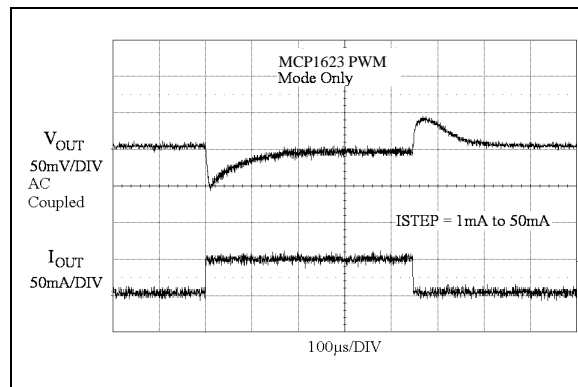

FIGURE 2-23: MCP1623 2.0V V_{OUT} Load Transient Waveforms.

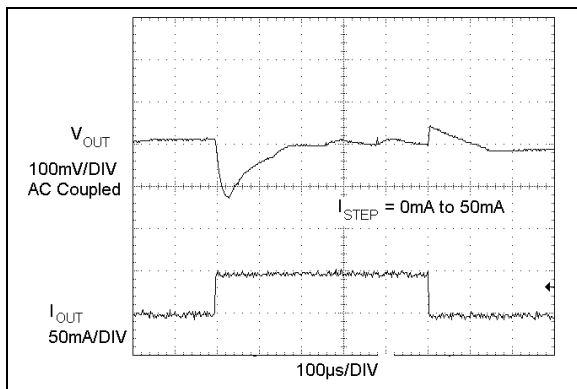

FIGURE 2-21: MCP1624 3.3V V_{OUT} Load Transient Waveforms.

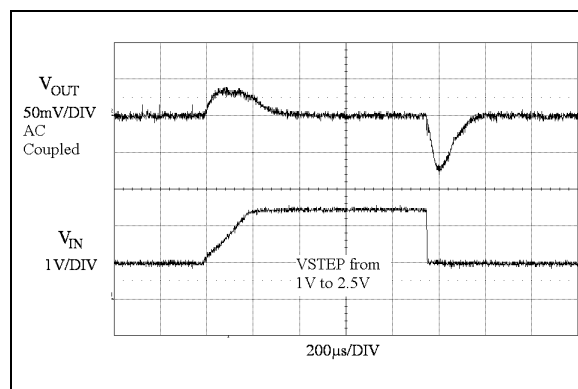

FIGURE 2-24: 3.3V V_{OUT} Line Transient Waveforms.

3.0 PIN DESCRIPTIONS

The descriptions of the pins are listed in [Table 3-1](#).

TABLE 3-1: PIN FUNCTION TABLE

MCP1623/24		Symbol	Description
SOT-23	2x3 DFN		
1	5	SW	Switch Node, Boost Inductor Input Pin
2	—	GND	Ground Pin
3	4	EN	Enable Control Input Pin
4	1	FB	Feedback Voltage Pin
5	—	V _{OUT}	Output Voltage Pin
6	8	V _{IN}	Input Voltage Pin
—	2	S _{GND}	Signal Ground Pin
—	3	P _{GND}	Power Ground Pin
—	7	V _{OUTS}	Output Voltage Sense Pin
—	6	V _{OUTP}	Output Voltage Power Pin
—	9	EP	Exposed Thermal Pad (EP); must be connected to V _{SS} .

3.1 Switch Node Pin (SW)

Connects the inductor from the input voltage to the SW pin. The SW pin carries inductor current and can be as high as 425 mA peak. The integrated N-Channel switch drain and integrated P-Channel switch source are internally connected at the SW node.

3.2 Ground Pin (GND)

The ground or return pin is used for circuit ground connection. Length of trace from input cap return, output cap return and GND pin should be made as short as possible to minimize noise on the GND pin.

3.3 Enable Pin (EN)

The EN pin is a logic-level input used to enable or disable device switching and lower quiescent current while disabled. A logic high (greater than 90% of V_{IN}) will enable the regulator output. A logic low (less than 20% of V_{IN}) will ensure that the regulator is disabled.

3.4 Feedback Voltage Pin (FB)

The FB pin is used to provide output voltage regulation by using a resistor divider. The FB voltage will be 1.21V typical with the output voltage in regulation.

3.5 Output Voltage Pin (V_{OUT})

The output voltage pin connects the integrated P-Channel MOSFET to the output capacitor. The FB voltage divider is also connected to the V_{OUT} pin for voltage regulation.

3.6 Power Supply Input Voltage Pin (V_{IN})

Connects the input voltage source to V_{IN}. The input source should be decoupled to GND with a 4.7 μF minimum capacitor.

3.7 Signal Ground Pin (S_{GND})

The signal ground pin is used as a return for the integrated V_{REF} and error amplifier. In the 2x3 DFN package, the S_{GND} and power ground (P_{GND}) pins are connected externally.

3.8 Power Ground Pin (P_{GND})

The power ground pin is used as a return for the high-current N-Channel switch. In the 2x3 DFN package, the P_{GND} and signal ground (S_{GND}) pins are connected externally.

3.9 Output Voltage Sense Pin (V_{OUTS})

The output voltage sense pin connects the regulated output voltage to the internal bias circuits. In the 2x3 DFN package, V_{OUTS} and V_{OUTP} are connected externally.

3.10 Output Voltage Power Pin (V_{OUTP})

The output voltage power pin connects the output voltage to the switch node. High current flows through the integrated P-Channel and out of this pin to the output capacitor and output. In the 2x3 DFN package, V_{OUTS} and V_{OUTP} are connected externally.

3.11 Exposed Thermal Pad (EP)

There is an internal electrical connection between the Exposed Thermal Pad (EP) and the V_{SS} pin; they must be connected to the same potential on the Printed Circuit Board (PCB).

MCP1623/24

NOTES:

4.0 DETAILED DESCRIPTION

4.1 Device Option Overview

The MCP1623/24 family of devices is capable of low start-up voltage and delivers high efficiency over a wide load range for single-cell, two-cell, three-cell alkaline, NiMH, NiCd and single-cell Li-Ion battery inputs. A high level of integration lowers total system cost, eases implementation and reduces board area. The devices feature low start-up voltage, adjustable output voltage, PWM/PFM mode operation, low I_Q , integrated synchronous switch, internal compensation, low noise anti-ringing control, inrush current limit and soft start. There is one feature option for the MCP1623/24 family: PWM/PFM mode or PWM mode only.

4.1.1 PWM/PFM MODE OPTION

The MCP1624 devices use an automatic switchover from PWM to PFM mode for light load conditions to maximize efficiency over a wide range of output current. During PFM mode, higher peak current is used to pump the output up to the threshold limit. While operating in PFM or PWM mode, the P-Channel switch is used as a synchronous rectifier, turning off when the inductor current reaches 0 mA to maximize efficiency. In PFM mode, a comparator is used to terminate switching when the output voltage reaches the upper threshold limit. Once switching has terminated, the output voltage will decay or coast down. During this period, very low I_Q is consumed from the device and input source, which keeps power efficiency high at light load. The disadvantages of PWM/PFM mode are higher output ripple voltage and variable PFM mode frequency. The PFM mode frequency is a function of input voltage, output voltage and load. While in PFM mode, the boost converter pumps the output up at a switching frequency of 500 kHz.

4.1.2 PWM MODE ONLY OPTION

The MCP1623 devices disable PFM mode switching, and operate only in PWM mode over the entire load range. During periods of light load operation, the MCP1623 continues to operate at a constant 500 kHz switching frequency, keeping the output ripple voltage lower than PFM mode. During PWM-only mode, the MCP1623 P-Channel switch acts as a synchronous rectifier by turning off to prevent reverse current flow from the output cap back to the input in order to keep efficiency high. For noise immunity, the N-Channel MOSFET current sense is blanked for approximately 100 ns. With a typical minimum duty cycle of 100 ns, the MCP1623 continues to switch at a constant frequency under light load conditions. [Figure 2-12](#) represents the input voltage versus load current for the pulse-skipping threshold in PWM-only mode. At lighter loads, the MCP1623 device begins to skip pulses.

TABLE 4-1: PART NUMBER SELECTION

Part Number	PWM/PFM	PWM
MCP1623		X
MCP1624	X	

MCP1623/24

4.2 Functional Description

The MCP1623/24 is a compact, high-efficiency, fixed-frequency, step-up DC-DC converter that provides an easy-to-use power supply solution for PIC[®] microcontroller applications powered by either single-cell, two-cell, or three-cell alkaline, NiCd, or NiMH, and single-cell Li-Ion or Li-Polymer batteries.

Figure 4-1 depicts the functional block diagram of the MCP1623/24.

4.2.1 LOW-VOLTAGE START-UP

The MCP1623/24 is capable of starting from a low input voltage. Start-up voltage is typically 0.65V for a 3.3V output and 1 mA resistive load.

When enabled, the internal start-up logic turns the rectifying P-Channel switch on until the output capacitor is charged to a value close to the input voltage. The rectifying switch is current limited during this time. After charging the output capacitor to the input voltage, the device starts switching. If the input voltage is below 1.6V, the device runs open-loop with a fixed duty cycle of 70% until the output reaches 1.6V.

During this time, the boost switch current is limited to 50% of its nominal value. Once the output voltage reaches 1.6V, normal closed-loop PWM operation is initiated.

The MCP1623/24 charges an internal capacitor with a very weak current source. The voltage on this capacitor, in turn, slowly ramps the current limit of the boost switch to its nominal value. The soft-start capacitor is completely discharged in the event of a commanded shutdown or a thermal shutdown.

There is no undervoltage lockout feature for the MCP1623/24. The device will start up at the lowest possible voltage and run down to the lowest possible voltage. For typical battery applications, this may result in “motor-boating” for deeply discharged batteries.

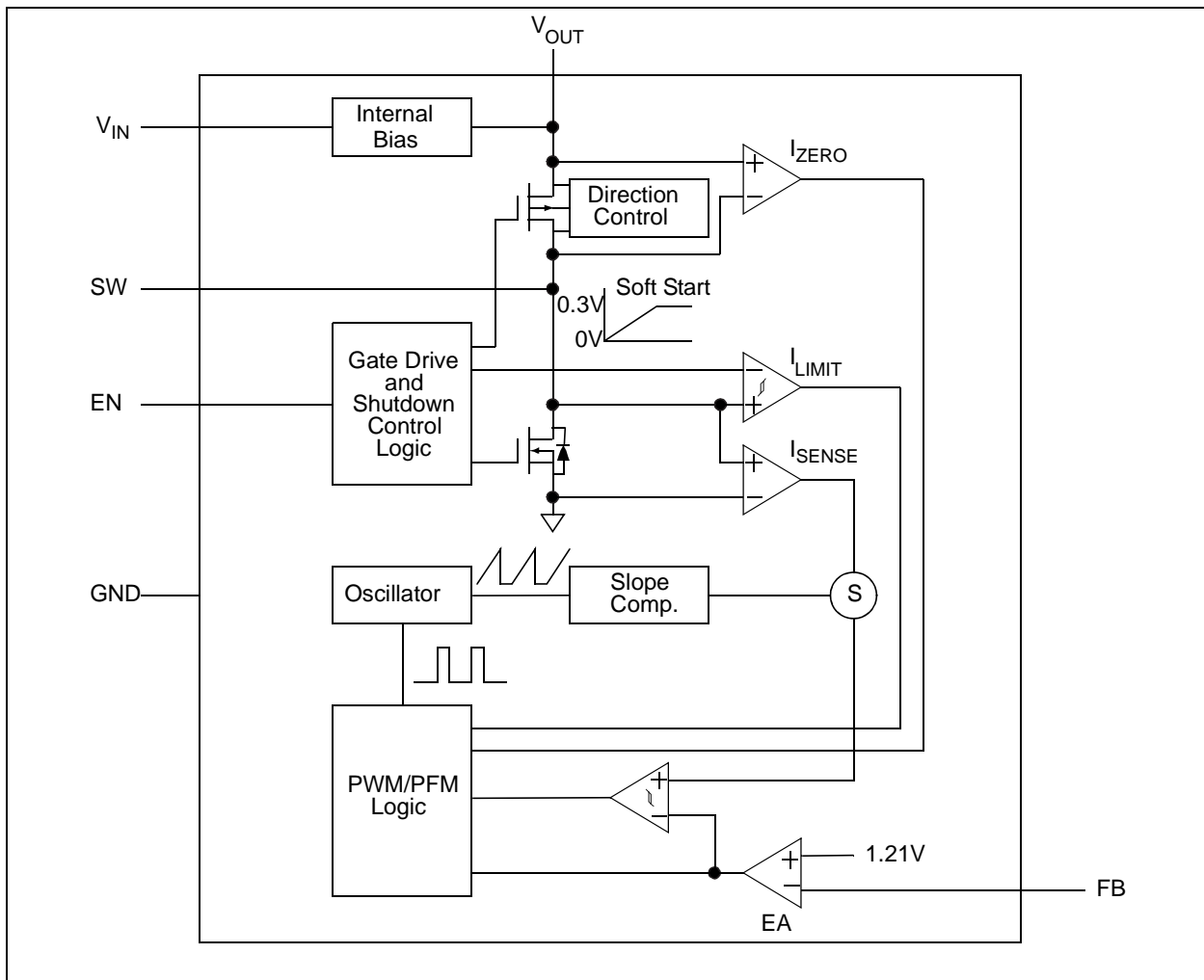

FIGURE 4-1: MCP1623/24 Block Diagram.

4.2.2 PWM MODE OPERATION

In normal PWM operation, the MCP1623/24 operates as a fixed frequency, synchronous boost converter. The switching frequency is internally maintained with an oscillator typically set to 500 kHz. The MCP1623 device will operate in PWM-only mode even during periods of light load operation. By operating in PWM-only mode, the output ripple remains low and the frequency is constant. Operating in fixed PWM mode results in lower efficiency during light load operation (when compared to PFM mode (MCP1624)).

Lossless current sensing converts the peak current signal to a voltage to sum with the internal slope compensation. This summed signal is compared to the voltage error amplifier output to provide a peak current control command for the PWM signal. The slope compensation is adaptive to the input and output voltage. Therefore, the converter provides the proper amount of slope compensation to ensure stability, but is not excessive, which causes a loss of phase margin. The peak current limit is set to 425 mA typical.

4.2.3 PFM MODE OPERATION

The MCP1624 device is capable of operating in normal PWM mode and PFM mode to maintain high efficiency at all loads. In PFM mode, the output ripple has a variable frequency component that changes with the input voltage and output current. With no load, the quiescent current draw from the output is typically 19 μ A. The PFM mode can be disabled in selected device options.

PFM operation is initiated if the output load current falls below an internally programmed threshold. The output voltage is continuously monitored. When the output voltage drops below its nominal value, PFM operation pulses one or several times to bring the output back into regulation. If the output load current rises above the upper threshold, the MCP1624 transitions smoothly into PWM mode.

4.2.4 ADJUSTABLE OUTPUT VOLTAGE

The MCP1623/24 output voltage is adjustable with a resistor divider over a 2.0V minimum to 5.5V maximum range. High-value resistors are recommended to minimize quiescent current to keep efficiency high at light loads.

4.2.5 ENABLE/OUTPUT DISCONNECT

The enable pin is used to turn the boost converter on and off. The enable threshold voltage varies with input voltage. To enable the boost converter, the EN voltage level must be greater than 90% of the V_{IN} voltage. To disable the boost converter, the EN voltage must be less than 20% of the V_{IN} voltage.

The MCP1623/24 devices incorporate a true output disconnect feature. With the EN pin pulled low, the output of the MCP1623/24 is isolated or disconnected from the input by turning off the integrated P-Channel switch and removing the switch bulk diode connection. This removes the DC path typical in boost converters, which allows the output to be disconnected from the input. During this mode, less than 1 μ A of current is consumed from the input (battery). True output disconnect does not discharge the output; the output voltage is held up by the external C_{OUT} capacitance.

4.2.6 INTERNAL BIAS

The MCP1623/24 gets its start-up bias from V_{IN} . Once the output exceeds the input, bias comes from the output. Therefore, once started, operation is completely independent of V_{IN} . Operation is only limited by the output power level and the input source series resistance. Once started, the output will remain in regulation down to 0.35V typical with 1 mA output current for low source impedance inputs.

4.2.7 INTERNAL COMPENSATION

The error amplifier, with its associated compensation network, completes the closed-loop system by comparing the output voltage to a reference at the input of the error amplifier, and feeding the amplified and inverted signal to the control input of the inner current loop. The compensation network provides phase leads and lags at appropriate frequencies to cancel excessive phase lags and leads of the power circuit. All necessary compensation components and slope compensation are integrated.

4.2.8 SHORT-CIRCUIT PROTECTION

Unlike most boost converters, the MCP1623/24 allows its output to be shorted during normal operation. The internal current limit and overtemperature protection limit excessive stress and protect the device during periods of short circuit, overcurrent and overtemperature.

4.2.9 LOW-NOISE OPERATION

The MCP1623/24 integrates a low-noise anti-ringing switch that damps the oscillations typically observed at the switch node of a boost converter when operating in the Discontinuous Inductor Current mode. This removes the high-frequency radiated noise.

4.2.10 OVERTEMPERATURE PROTECTION

Overtemperature protection circuitry is integrated in the MCP1623/24. This circuitry monitors the device junction temperature and shuts the device off if the junction temperature exceeds the typical +150°C threshold. If this threshold is exceeded, the device will automatically restart once the junction temperature drops by 10°C. The soft start is reset during an overtemperature condition.

MCP1623/24

NOTES:

5.0 APPLICATION INFORMATION

5.1 Typical Applications

The MCP1623/24 synchronous boost regulator operates over a wide input voltage and output voltage range. The power efficiency is high for several decades of load range. Output current capability increases with input voltage and decreases with increasing output voltage. The maximum output current is based on the N-Channel peak current limit. Typical characterization curves in this data sheet are presented to display the typical output current capability.

5.2 Adjustable Output Voltage Calculations

To calculate the resistor divider values for the MCP1623/24, Equation 5-1 can be used, where R_{TOP} is connected to V_{OUT} , R_{BOT} is connected to GND and both are connected to the FB input pin.

EQUATION 5-1:

$$R_{TOP} = R_{BOT} \times \left(\frac{V_{OUT}}{V_{FB}} - 1 \right)$$

EXAMPLE 1:

$$\begin{aligned} V_{OUT} &= 3.3V \\ V_{FB} &= 1.21V \\ R_{BOT} &= 309 \text{ k}\Omega \\ R_{TOP} &= 533.7 \text{ k}\Omega \text{ (Standard Value = 536 k}\Omega\text{)} \end{aligned}$$

EXAMPLE 2:

$$\begin{aligned} V_{OUT} &= 5.0V \\ V_{FB} &= 1.21V \\ R_{BOT} &= 309 \text{ k}\Omega \\ R_{TOP} &= 967.9 \text{ k}\Omega \text{ (Standard Value = 976 k}\Omega\text{)} \end{aligned}$$

There are some potential issues with higher value resistors. For small surface mount resistors, environment contamination can create leakage paths that significantly change the resistor divider that effect the output voltage. The FB input leakage current can also impact the divider and change the output voltage tolerance.

5.3 Input Capacitor Selection

The boost input current is smoothed by the boost inductor reducing the amount of filtering necessary at the input. Some capacitance is recommended to provide decoupling from the source. Low ESR X5R or X7R are well suited since they have a low-temperature coefficient and small size. For most applications, 4.7 μF of capacitance is sufficient at the input. For high-power applications that have high source impedance or long leads, connecting the battery to the input 10 μF of capacitance is recommended. Additional input capacitance can be added to provide a stable input voltage.

Table 5-1 contains the recommended range for the input capacitor value.

5.4 Output Capacitor Selection

The output capacitor helps provide a stable output voltage during sudden load transients and reduces the output voltage ripple. As with the input capacitor, X5R and X7R ceramic capacitors are well suited for this application.

The MCP1623/24 is internally compensated so output capacitance range is limited. See Table 5-1 for the recommended output capacitor range.

While the N-Channel switch is on, the output current is supplied by the output capacitor C_{OUT} . The amount of output capacitance and equivalent series resistance will have a significant effect on the output ripple voltage. While C_{OUT} provides load current, a voltage drop also appears across its internal ESR that results in ripple voltage.

EQUATION 5-2:

$$I_{OUT} = C_{OUT} \times \left(\frac{dV}{dt} \right)$$

Where:

dV = ripple voltage

dt = On time of the N-Channel switch
($D \times 1/F_{SW}$)

Table 5-1 contains the recommended range for the input and output capacitor value.

TABLE 5-1: CAPACITOR VALUE RANGE

	C_{IN}	C_{OUT}
Min.	4.7 μF	10 μF
Max.	—	100 μF

MCP1623/24

5.5 Inductor Selection

The MCP1623/24 is designed to be used with small surface-mount inductors; the inductance value can range from 2.2 μH to 10 μH . An inductance value of 4.7 μH is recommended to achieve a good balance between inductor size, converter load transient response and minimized noise.

TABLE 5-2: MCP1623/24 RECOMMENDED INDUCTORS

Part Number	Value (μH)	DCR Ω (typ)	I _{SAT} (A)	Size WxLxH (mm)
Coilcraft				
ME3220	4.7	0.190	1.5	2.5x3.2x2.0
LPS3015	4.7	0.200	1.2	3.0x3.0x1.5
EPL3012	4.7	0.165	1.0	3.0x3.0x1.3
XPL2010	4.7	0.336	0.75	1.9x2.0x1.0
Coiltronics®				
SD3110	4.7	0.285	0.68	3.1x3.1x1.0
SD3112	4.7	0.246	0.80	3.1x3.1x1.2
SD3114	4.7	0.251	1.14	3.1x3.1x1.4
Würth Elektronik®				
WE-TPC Type TH	4.7	0.200	0.8	2.8x2.8x1.35
WE-TPC Type S	4.7	0.105	0.90	3.8x3.8x1.65
WE-TPC Type M	4.7	0.082	1.65	4.8x4.8x1.8
Sumida Corporation				
CMH23	4.7	0.537	0.70	2.3x2.3x1.0
CMD4D06	4.7	0.216	0.75	3.5x4.3x0.8
CDRH4D	4.7	0.09	0.800	4.6x4.6x1.5
TDK Corporation				
B82462A2472M000	4.7	0.084	2.00	6.0x6.0x2.5
B82462G4472M	4.7	0.04	1.8	6.3x6.3x3.0

Several parameters are used to select the correct inductor: maximum rated current, saturation current and copper resistance (ESR). For boost converters, the inductor current can be much higher than the output current. The lower the inductor ESR, the higher the efficiency of the converter, a common trade-off in size versus efficiency.

Peak current is the maximum or limit, and saturation current typically specifies a point at which the inductance has rolled off a percentage of the rated value. This can range from a 20% to 40% reduction in inductance. As inductance rolls off, the inductor ripple current increases as does the peak switch current. It is important to keep the inductance from rolling off too much, causing switch current to reach the peak limit.

5.6 Thermal Calculations

By calculating the power dissipation and applying the package thermal resistance, (θ_{JA}), the junction temperature is estimated. The maximum continuous junction temperature rating for the MCP1623/24 is +125°C.

To quickly estimate the internal power dissipation for the switching boost regulator, an empirical calculation using measured efficiency can be used. Given the measured efficiency, the internal power dissipation is estimated by [Equation 5-3](#).

EQUATION 5-3:

$$\left(\frac{V_{OUT} \times I_{OUT}}{\text{Efficiency}} \right) - (V_{OUT} \times I_{OUT}) = P_{Dis}$$

The difference between the first term, input power, and the second term, power delivered, is the internal MCP1623/24 power dissipation. This is an estimate assuming that most of the power lost is internal to the MCP1623/24 and not C_{IN}, C_{OUT} and the inductor. There is some percentage of power lost in the boost inductor, with very little loss in the input and output capacitors. For a more accurate estimation of internal power dissipation, subtract the I_{INRMS}² x L_{ESR} power dissipation.

5.7 PCB Layout Information

Good printed circuit board layout techniques are important to any switching circuitry and switching power supplies are no different. When wiring the switching high-current paths, short and wide traces should be used. Therefore, it is important that the input and output capacitors be placed as close as possible to the MCP1623/24 to minimize the loop area.

The feedback resistors and feedback signal should be routed away from the switching node and the switching current loop. When possible, ground planes and traces should be used to help shield the feedback signal and minimize noise and magnetic interference.

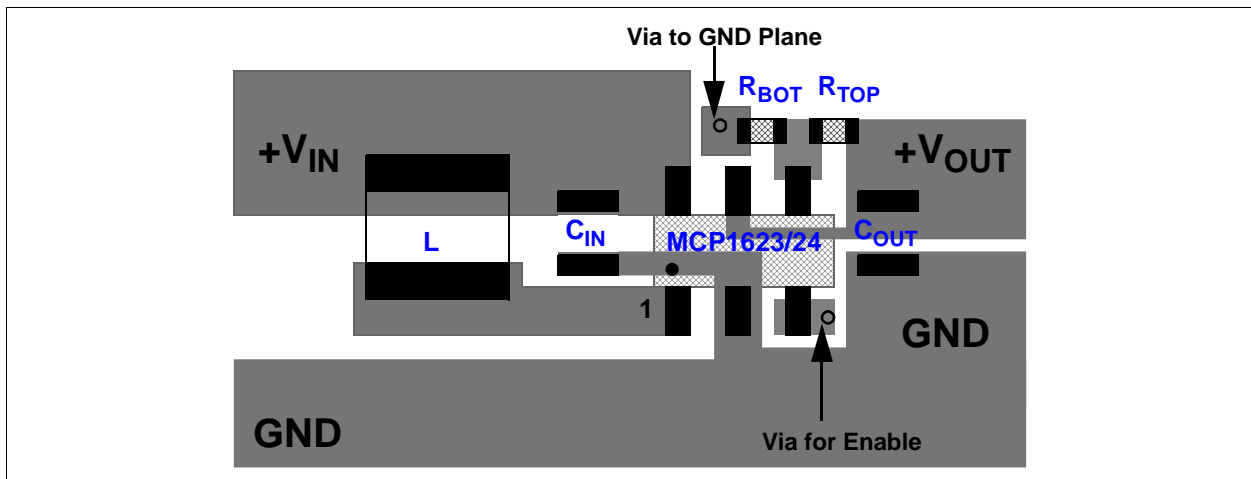

FIGURE 5-1: MCP1623/24 SOT-23-6 Recommended Layout.

MCP1623/24

NOTES:

6.0 PACKAGING INFORMATION

6.1 Package Marking Information (Not to Scale)

6-Lead SOT-23

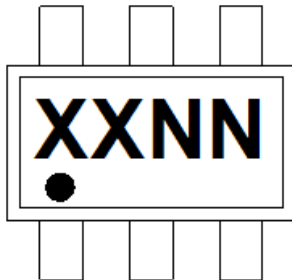

Part Number	Code
MCP1623T-I/CHY	HUNN
MCP1623T-I/CH	JANN
MCP1623T-I/CH	JUNN
MCP1624T-I/CHY	CJNN
MCP1624T-I/CH	JTNN

Example

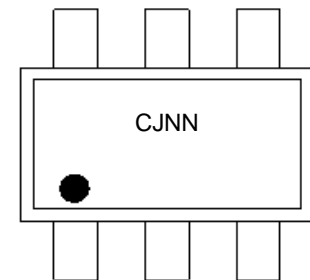

8-Lead DFN (2x3x0.9 mm)



Part Number	Code
MCP1623-I/MC	AKH
MCP1623T-I/MC	AKH
MCP1624-I/MC	ALH
MCP1624T-I/MC	ALH

Example

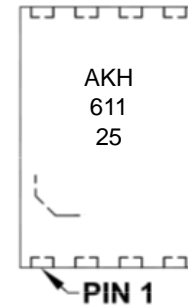

Legend:	XX...X	Customer-specific information
	Y	Year code (last digit of calendar year)
	YY	Year code (last 2 digits of calendar year)
	WW	Week code (week of January 1 is week '01')
	NNN	Alphanumeric traceability code
	Ⓔ3	Pb-free JEDEC [®] designator for Matte Tin (Sn)
	*	This package is Pb-free. The Pb-free JEDEC [®] designator (Ⓔ3) can be found on the outer packaging for this package.

Note: In the event the full Microchip part number cannot be marked on one line, it will be carried over to the next line, thus limiting the number of available characters for customer-specific information.

MCP1623/24

6-Lead Plastic Small Outline Transistor (CHY) [SOT-23]

Note: For the most current package drawings, please see the Microchip Packaging Specification located at <http://www.microchip.com/packaging>

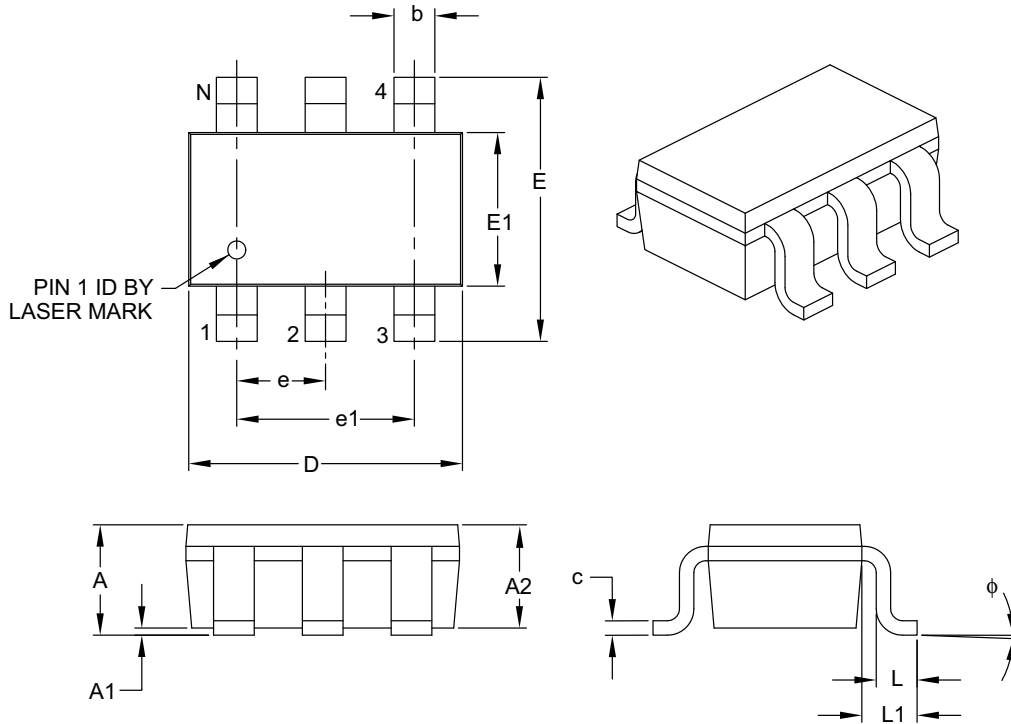

Dimension Limits	Units	MILLIMETERS		
		MIN	NOM	MAX
Number of Pins	N	6		
Pitch	e	0.95 BSC		
Outside Lead Pitch	e1	1.90 BSC		
Overall Height	A	0.90	–	1.45
Molded Package Thickness	A2	0.89	–	1.30
Standoff	A1	0.00	–	0.15
Overall Width	E	2.20	–	3.20
Molded Package Width	E1	1.30	–	1.80
Overall Length	D	2.70	–	3.10
Foot Length	L	0.10	–	0.60
Footprint	L1	0.35	–	0.80
Foot Angle	ϕ	0°	–	30°
Lead Thickness	c	0.08	–	0.26
Lead Width	b	0.20	–	0.51

Notes:

- Dimensions D and E1 do not include mold flash or protrusions. Mold flash or protrusions shall not exceed 0.127 mm per side.
- Dimensioning and tolerancing per ASME Y14.5M.
BSC: Basic Dimension. Theoretically exact value shown without tolerances.

Microchip Technology Drawing C04-028B

6-Lead Plastic Small Outline Transistor (CHY) [SOT-23]

Note: For the most current package drawings, please see the Microchip Packaging Specification located at <http://www.microchip.com/packaging>

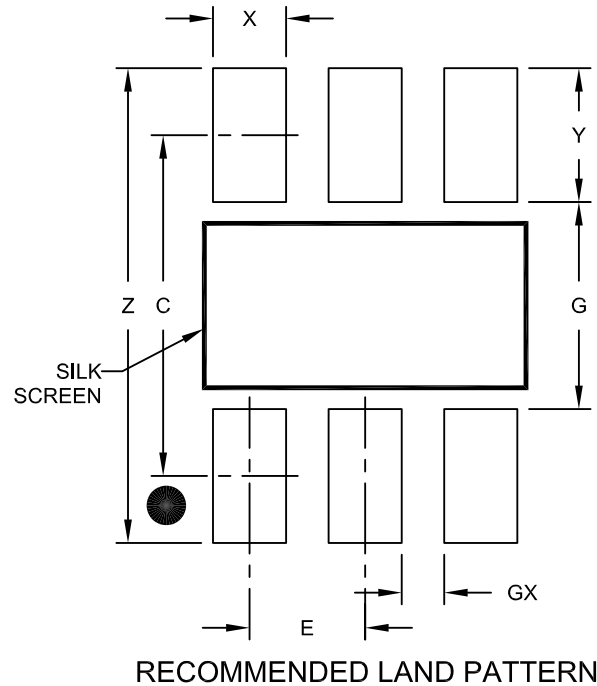

Dimension	Units	MILLIMETERS		
		MIN	NOM	MAX
Contact Pitch	E	0.95 BSC		
Contact Pad Spacing	C		2.80	
Contact Pad Width (X6)	X			0.60
Contact Pad Length (X6)	Y			1.10
Distance Between Pads	G	1.70		
Distance Between Pads	GX	0.35		
Overall Width	Z			3.90

Notes:

1. Dimensioning and tolerancing per ASME Y14.5M

BSC: Basic Dimension. Theoretically exact value shown without tolerances.

Microchip Technology Drawing No. C04-2028A

MCP1623/24

8-Lead Plastic Dual Flat, No Lead Package (MC) – 2x3x0.9 mm Body [DFN]

Note: For the most current package drawings, please see the Microchip Packaging Specification located at <http://www.microchip.com/packaging>

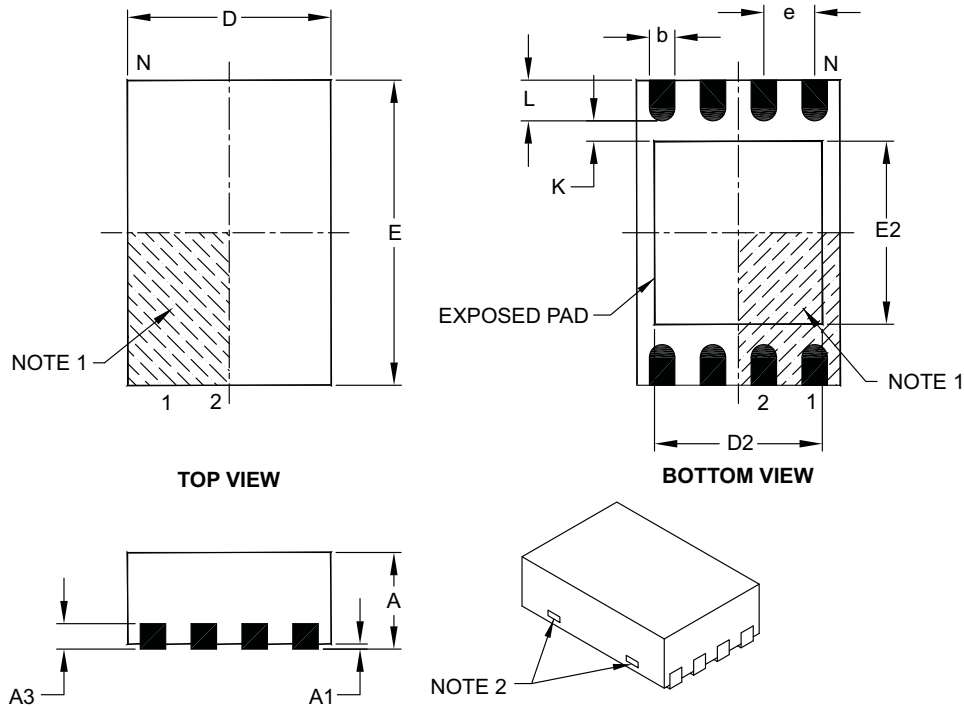

Dimension Limits	Units	MILLIMETERS		
		MIN	NOM	MAX
Number of Pins	N	8		
Pitch	e	0.50 BSC		
Overall Height	A	0.80	0.90	1.00
Standoff	A1	0.00	0.02	0.05
Contact Thickness	A3	0.20 REF		
Overall Length	D	2.00 BSC		
Overall Width	E	3.00 BSC		
Exposed Pad Length	D2	1.30	–	1.55
Exposed Pad Width	E2	1.50	–	1.75
Contact Width	b	0.20	0.25	0.30
Contact Length	L	0.30	0.40	0.50
Contact-to-Exposed Pad	K	0.20	–	–

Notes:

- Pin 1 visual index feature may vary, but must be located within the hatched area.
- Package may have one or more exposed tie bars at ends.
- Package is saw singulated.
- Dimensioning and tolerancing per ASME Y14.5M.
 BSC: Basic Dimension. Theoretically exact value shown without tolerances.
 REF: Reference Dimension, usually without tolerance, for information purposes only.

Microchip Technology Drawing C04-123C

8-Lead Plastic Dual Flat, No Lead Package (MC) - 2x3x0.9mm Body [DFN]

Note: For the most current package drawings, please see the Microchip Packaging Specification located at <http://www.microchip.com/packaging>

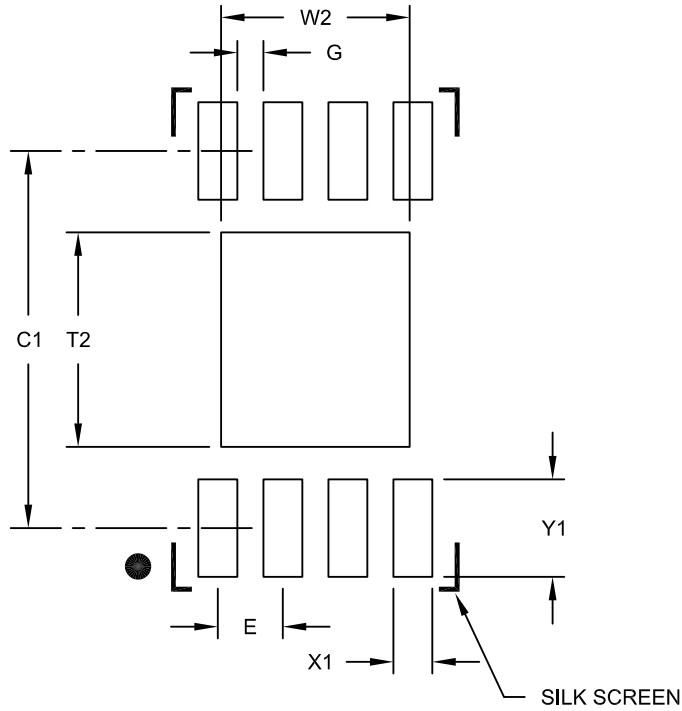

RECOMMENDED LAND PATTERN

Dimension Limits	Units	MILLIMETERS		
		MIN	NOM	MAX
Contact Pitch	E	0.50 BSC		
Optional Center Pad Width	W2			1.45
Optional Center Pad Length	T2			1.75
Contact Pad Spacing	C1		2.90	
Contact Pad Width (X8)	X1			0.30
Contact Pad Length (X8)	Y1			0.75
Distance Between Pads	G	0.20		

Notes:

1. Dimensioning and tolerancing per ASME Y14.5M

BSC: Basic Dimension. Theoretically exact value shown without tolerances.

Microchip Technology Drawing No. C04-2123B

MCP1623/24

NOTES:

APPENDIX A: REVISION HISTORY

Revision D (September 2016)

The following is the list of modifications:

1. Minor modifications in DC Characteristics table (n-channel and p-channel max. leakage specs).
2. Minor typographical corrections.

Revision C (February 2011)

The following is the list of modifications:

1. Added the 8-lead, 2x3 DFN package and related information throughout the document.
2. Updated the package marking information and drawings.
3. Updated the [Product Identification System](#) page.

Revision B (July 2010)

The following is the list of modifications:

1. Updated the packaging specification.

Revision A (May 2010)

- Initial release of the document.

MCP1623/24

NOTES:

PRODUCT IDENTIFICATION SYSTEM

To order or obtain information, e.g., on pricing or delivery, refer to the factory or the listed sales office.

<u>PART NO.</u>	<u>IXI⁽¹⁾</u>	<u>X</u>	<u>IXX</u>
Device	Tape and Reel Option	Temperature Range	Package
<p>Device:</p> <p>MCP1623: 0.65V, PWM Only True Disconnect, Sync Boost Regulator</p> <p>MCP1624: 0.65V, PWM/PFM True Disconnect, Sync Boost Regulator</p>	<p>Tape and Reel Option:</p> <p>Blank = Standard packaging (tube or tray)</p> <p>T = Tape and Reel⁽¹⁾</p>	<p>Temperature Range:</p> <p>I = -40°C to +85°C (Industrial)</p>	<p>Package:</p> <p>CH = Plastic Small Outline Transistor (SOT-23), 6-lead</p> <p>CHY* = Plastic Small Outline Transistor (SOT-23), 6-lead</p> <p>MC = Plastic Dual Flat, No Lead (2x3 DFN), 8-lead</p> <p>Y* = Nickel palladium gold manufacturing designator. Only available on the SOT-23 package.</p>
<p>Examples:</p> <p>a) MCP1623T-I/CHY: Tape and Reel, 0.65V, Sync Reg., 6LD SOT-23 package</p> <p>b) MCP1624T-I/CHY: Tape and Reel, 0.65V, Sync Reg., 6LD SOT-23 package</p> <p>c) MCP1623-I/MC: 0.65V, Sync Reg., 8LD DFN package</p> <p>d) MCP1623T-I/MC: Tape and Reel, 0.65V, Sync Reg., 8LD DFN package</p> <p>e) MCP1624-I/MC: 0.65V, Sync Reg., 8LD DFN package</p> <p>f) MCP1624T-I/MC: Tape and Reel, 0.65V, Sync Reg., 8LD DFN package</p>			
<p>Note 1: Tape and Reel identifier only appears in the catalog part number description. This identifier is used for ordering purposes and is not printed on the device package. Check with your Microchip Sales Office for package availability with the Tape and Reel option.</p>			

MCP1623/24

NOTES:

Note the following details of the code protection feature on Microchip devices:

- Microchip products meet the specification contained in their particular Microchip Data Sheet.
- Microchip believes that its family of products is one of the most secure families of its kind on the market today, when used in the intended manner and under normal conditions.
- There are dishonest and possibly illegal methods used to breach the code protection feature. All of these methods, to our knowledge, require using the Microchip products in a manner outside the operating specifications contained in Microchip's Data Sheets. Most likely, the person doing so is engaged in theft of intellectual property.
- Microchip is willing to work with the customer who is concerned about the integrity of their code.
- Neither Microchip nor any other semiconductor manufacturer can guarantee the security of their code. Code protection does not mean that we are guaranteeing the product as “unbreakable.”

Code protection is constantly evolving. We at Microchip are committed to continuously improving the code protection features of our products. Attempts to break Microchip's code protection feature may be a violation of the Digital Millennium Copyright Act. If such acts allow unauthorized access to your software or other copyrighted work, you may have a right to sue for relief under that Act.

Information contained in this publication regarding device applications and the like is provided only for your convenience and may be superseded by updates. It is your responsibility to ensure that your application meets with your specifications. MICROCHIP MAKES NO REPRESENTATIONS OR WARRANTIES OF ANY KIND WHETHER EXPRESS OR IMPLIED, WRITTEN OR ORAL, STATUTORY OR OTHERWISE, RELATED TO THE INFORMATION, INCLUDING BUT NOT LIMITED TO ITS CONDITION, QUALITY, PERFORMANCE, MERCHANTABILITY OR FITNESS FOR PURPOSE. Microchip disclaims all liability arising from this information and its use. Use of Microchip devices in life support and/or safety applications is entirely at the buyer's risk, and the buyer agrees to defend, indemnify and hold harmless Microchip from any and all damages, claims, suits, or expenses resulting from such use. No licenses are conveyed, implicitly or otherwise, under any Microchip intellectual property rights unless otherwise stated.

Microchip received ISO/TS-16949:2009 certification for its worldwide headquarters, design and wafer fabrication facilities in Chandler and Tempe, Arizona; Gresham, Oregon and design centers in California and India. The Company's quality system processes and procedures are for its PIC® MCUs and dsPIC® DSCs, KEELoC® code hopping devices, Serial EEPROMs, microperipherals, nonvolatile memory and analog products. In addition, Microchip's quality system for the design and manufacture of development systems is ISO 9001:2000 certified.

**QUALITY MANAGEMENT SYSTEM
CERTIFIED BY DNV
= ISO/TS 16949 =**

Trademarks

The Microchip name and logo, the Microchip logo, AnyRate, dsPIC, FlashFlex, flexPWR, Heldo, JukeBlox, KeeLoq, KeeLoq logo, Klear, LANCheck, LINK MD, MediaLB, MOST, MOST logo, MPLAB, OptoLyzer, PIC, PICSTART, PIC32 logo, RightTouch, SpyNIC, SST, SST Logo, SuperFlash and UNI/O are registered trademarks of Microchip Technology Incorporated in the U.S.A. and other countries.

ClockWorks, The Embedded Control Solutions Company, ETHERSYNCH, Hyper Speed Control, HyperLight Load, IntelliMOS, mTouch, Precision Edge, and QUIET-WIRE are registered trademarks of Microchip Technology Incorporated in the U.S.A.

Analog-for-the-Digital Age, Any Capacitor, AnyIn, AnyOut, BodyCom, chipKIT, chipKIT logo, CodeGuard, dsPICDEM, dsPICDEM.net, Dynamic Average Matching, DAM, ECAN, EtherGREEN, In-Circuit Serial Programming, ICSP, Inter-Chip Connectivity, JitterBlocker, KlearNet, KlearNet logo, MiWi, motorBench, MPASM, MPF, MPLAB Certified logo, MPLIB, MPLINK, MultiTRAK, NetDetach, Omniscient Code Generation, PICDEM, PICDEM.net, PICkit, PICtail, PureSilicon, RightTouch logo, REAL ICE, Ripple Blocker, Serial Quad I/O, SQL, SuperSwitcher, SuperSwitcher II, Total Endurance, TSHARC, USBCheck, VariSense, ViewSpan, WiperLock, Wireless DNA, and ZENA are trademarks of Microchip Technology Incorporated in the U.S.A. and other countries.

SQTP is a service mark of Microchip Technology Incorporated in the U.S.A.

Silicon Storage Technology is a registered trademark of Microchip Technology Inc. in other countries.

GestIC is a registered trademarks of Microchip Technology Germany II GmbH & Co. KG, a subsidiary of Microchip Technology Inc., in other countries.

All other trademarks mentioned herein are property of their respective companies.

© 2010-2016, Microchip Technology Incorporated, Printed in the U.S.A., All Rights Reserved.

ISBN: 978-1-5224-0920-5



MICROCHIP

Worldwide Sales and Service

AMERICAS

Corporate Office

2355 West Chandler Blvd.
Chandler, AZ 85224-6199

Tel: 480-792-7200

Fax: 480-792-7277

Technical Support:

[http://www.microchip.com/
support](http://www.microchip.com/support)

Web Address:

www.microchip.com

Atlanta

Duluth, GA

Tel: 678-957-9614

Fax: 678-957-1455

Austin, TX

Tel: 512-257-3370

Boston

Westborough, MA

Tel: 774-760-0087

Fax: 774-760-0088

Chicago

Itasca, IL

Tel: 630-285-0071

Fax: 630-285-0075

Cleveland

Independence, OH

Tel: 216-447-0464

Fax: 216-447-0643

Dallas

Addison, TX

Tel: 972-818-7423

Fax: 972-818-2924

Detroit

Novi, MI

Tel: 248-848-4000

Houston, TX

Tel: 281-894-5983

Indianapolis

Noblesville, IN

Tel: 317-773-8323

Fax: 317-773-5453

Los Angeles

Mission Viejo, CA

Tel: 949-462-9523

Fax: 949-462-9608

New York, NY

Tel: 631-435-6000

San Jose, CA

Tel: 408-735-9110

Canada - Toronto

Tel: 905-695-1980

Fax: 905-695-2078

ASIA/PACIFIC

Asia Pacific Office

Suites 3707-14, 37th Floor
Tower 6, The Gateway
Harbour City, Kowloon

Hong Kong

Tel: 852-2943-5100

Fax: 852-2401-3431

Australia - Sydney

Tel: 61-2-9868-6733

Fax: 61-2-9868-6755

China - Beijing

Tel: 86-10-8569-7000

Fax: 86-10-8528-2104

China - Chengdu

Tel: 86-28-8665-5511

Fax: 86-28-8665-7889

China - Chongqing

Tel: 86-23-8980-9588

Fax: 86-23-8980-9500

China - Dongguan

Tel: 86-769-8702-9880

China - Guangzhou

Tel: 86-20-8755-8029

China - Hangzhou

Tel: 86-571-8792-8115

Fax: 86-571-8792-8116

China - Hong Kong SAR

Tel: 852-2943-5100

Fax: 852-2401-3431

China - Nanjing

Tel: 86-25-8473-2460

Fax: 86-25-8473-2470

China - Qingdao

Tel: 86-532-8502-7355

Fax: 86-532-8502-7205

China - Shanghai

Tel: 86-21-5407-5533

Fax: 86-21-5407-5066

China - Shenyang

Tel: 86-24-2334-2829

Fax: 86-24-2334-2393

China - Shenzhen

Tel: 86-755-8864-2200

Fax: 86-755-8203-1760

China - Wuhan

Tel: 86-27-5980-5300

Fax: 86-27-5980-5118

China - Xian

Tel: 86-29-8833-7252

Fax: 86-29-8833-7256

ASIA/PACIFIC

China - Xiamen

Tel: 86-592-2388138

Fax: 86-592-2388130

China - Zhuhai

Tel: 86-756-3210040

Fax: 86-756-3210049

India - Bangalore

Tel: 91-80-3090-4444

Fax: 91-80-3090-4123

India - New Delhi

Tel: 91-11-4160-8631

Fax: 91-11-4160-8632

India - Pune

Tel: 91-20-3019-1500

Japan - Osaka

Tel: 81-6-6152-7160

Fax: 81-6-6152-9310

Japan - Tokyo

Tel: 81-3-6880-3770

Fax: 81-3-6880-3771

Korea - Daegu

Tel: 82-53-744-4301

Fax: 82-53-744-4302

Korea - Seoul

Tel: 82-2-554-7200

Fax: 82-2-558-5932 or

82-2-558-5934

Malaysia - Kuala Lumpur

Tel: 60-3-6201-9857

Fax: 60-3-6201-9859

Malaysia - Penang

Tel: 60-4-227-8870

Fax: 60-4-227-4068

Philippines - Manila

Tel: 63-2-634-9065

Fax: 63-2-634-9069

Singapore

Tel: 65-6334-8870

Fax: 65-6334-8850

Taiwan - Hsin Chu

Tel: 886-3-5778-366

Fax: 886-3-5770-955

Taiwan - Kaohsiung

Tel: 886-7-213-7828

Taiwan - Taipei

Tel: 886-2-2508-8600

Fax: 886-2-2508-0102

Thailand - Bangkok

Tel: 66-2-694-1351

Fax: 66-2-694-1350

EUROPE

Austria - Wels

Tel: 43-7242-2244-39

Fax: 43-7242-2244-393

Denmark - Copenhagen

Tel: 45-4450-2828

Fax: 45-4485-2829

France - Paris

Tel: 33-1-69-53-63-20

Fax: 33-1-69-30-90-79

Germany - Dusseldorf

Tel: 49-2129-3766400

Germany - Karlsruhe

Tel: 49-721-625370

Germany - Munich

Tel: 49-89-627-144-0

Fax: 49-89-627-144-44

Italy - Milan

Tel: 39-0331-742611

Fax: 39-0331-466781

Italy - Venice

Tel: 39-049-7625286

Netherlands - Drunen

Tel: 31-416-690399

Fax: 31-416-690340

Poland - Warsaw

Tel: 48-22-3325737

Spain - Madrid

Tel: 34-91-708-08-90

Fax: 34-91-708-08-91

Sweden - Stockholm

Tel: 46-8-5090-4654

UK - Wokingham

Tel: 44-118-921-5800

Fax: 44-118-921-5820

06/23/16

单击下面可查看定价，库存，交付和生命周期等信息

[>>Microchip Technology](#)