

3-Pin Microcontroller Reset Monitors

Features

- Precision V_{DD} Monitor for 2.5V, 3.0V, 3.3V, 5.0V Nominal System Voltage Supplies
- 140 msec Minimum RESET Time-Out Period
- RESET Output to $V_{DD} = 1.0V$ (**TCM809**)
- Low Supply Current, 9 μA (typ.)
- V_{DD} Transient Immunity
- Small 3-Pin SC-70 and SOT-23B Packages
- No External Components
- Push-Pull RESET Output
- Temperature Ranges:
 - Industrial: SC-70 (E): -40°C to +85°C
 - Extended: SOT-23, SC-70 (V): -40°C to +125°C

Applications

- Computers
- Embedded Systems
- Battery-powered Equipment
- Critical Microcontroller Power Supply Monitoring
- Automotive

Typical Application Circuit

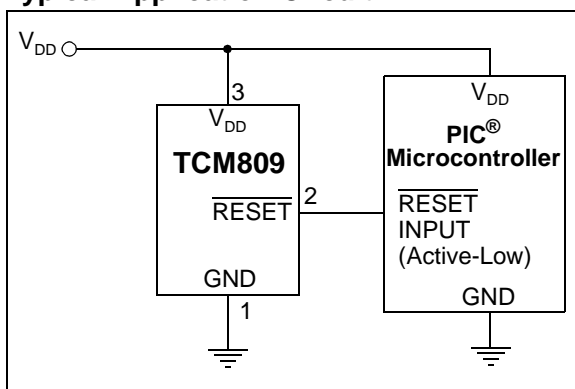

General Description

The TCM809 and TCM810 are cost-effective system supervisor circuits designed to monitor V_{DD} in digital systems; providing a reset signal to the host processor, when necessary. No external components are required.

The RESET output is typically driven active within 65 μsec of V_{DD} falling through the reset voltage threshold. RESET is maintained active for a minimum of 140 msec after V_{DD} rises above the reset threshold. The TCM810 has an active-high RESET output, while the TCM809 has an active-low RESET output. The output of the TCM809/TCM810 is valid down to $V_{DD} = 1V$. Both devices are available in 3-Pin SC-70 and SOT-23B packages.

The TCM809/TCM810 are optimized to reject fast transient glitches on the V_{DD} line. A low supply current of 9 μA (typ., $V_{DD} = 3.3V$) make these devices suitable for battery-powered applications.

Pin Configurations



TCM809/TCM810

1.0 ELECTRICAL CHARACTERISTICS

Absolute Maximum Ratings†

Supply Voltage (V_{DD} to GND)	6.0V
RESET, RESET	-0.3V to (V_{DD} + 0.3V)
Input Current, V_{DD}	20 mA
Output Current, RESET, RESET	20 mA
dV/dt (V_{DD})	100V/ μ sec
Operating Temperature Range	-40°C to +125°C
Power Dissipation ($T_A = 70^\circ\text{C}$):	
3-Pin SOT-23B (derate 4 mW/ $^\circ\text{C}$ above +70°C)	320 mW
3-Pin SC-70 (derate 2.17 mW/ $^\circ\text{C}$ above +70°C)	174 mW
Storage Temperature Range	-65°C to +150°C
Maximum Junction Temperature, T_J	150°C

† **Notice:** Stresses above those listed under "Maximum Ratings" may cause permanent damage to the device. This is a stress rating only and functional operation of the device at those or any other conditions above those indicated in the operational listings of this specification is not implied. Exposure to maximum rating conditions for extended periods may affect device reliability.

ELECTRICAL CHARACTERISTICS

V_{DD} = Full Range, T_A = Operating Temperature Range, unless otherwise noted. Typical values are at $T_A = +25^\circ\text{C}$, $V_{DD} = 5\text{V}$ for L/M/J, 3.3V for T/S, 3.0V for R and 2.5V for Z (Note 1).						
Parameter	Sym	Min	Typ	Max	Units	Test Conditions
V_{DD} Range		1.0	—	5.5	V	$T_A = 0^\circ\text{C}$ to $+70^\circ\text{C}$
		1.2	—	5.5		$T_A = -40^\circ\text{C}$ to $+125^\circ\text{C}$
Supply Current	I_{CC}	—	12	30	μA	TCM8xxL/M/J: $V_{DD} < 5.5\text{V}$
		—	9	25		TCM8xxR/S/T/Z: $V_{DD} < 3.6\text{V}$
Reset Threshold (Note 2)	V_{TH}	4.56	4.63	4.70	V	TCM8xxL: $T_A = +25^\circ\text{C}$
		4.50	—	4.75		$T_A = -40^\circ\text{C}$ to $+125^\circ\text{C}$
		4.31	4.38	4.45	V	TCM8xxM: $T_A = +25^\circ\text{C}$
		4.25	—	4.50	V	$T_A = -40^\circ\text{C}$ to $+125^\circ\text{C}$
		3.93	4.00	4.06	V	TCM809J: $T_A = +25^\circ\text{C}$
		3.89	—	4.10	V	$T_A = -40^\circ\text{C}$ to $+125^\circ\text{C}$
		3.04	3.08	3.11	V	TCM8xxT: $T_A = +25^\circ\text{C}$
		3.00	—	3.15	V	$T_A = -40^\circ\text{C}$ to $+125^\circ\text{C}$
		2.89	2.93	2.96	V	TCM8xxS: $T_A = +25^\circ\text{C}$
		2.85	—	3.00	V	$T_A = -40^\circ\text{C}$ to $+125^\circ\text{C}$
		2.59	2.63	2.66	V	TCM8xxR: $T_A = +25^\circ\text{C}$
		2.55	—	2.70	V	$T_A = -40^\circ\text{C}$ to $+125^\circ\text{C}$
		2.28	2.32	2.35	V	TCM8xxZ: $T_A = +25^\circ\text{C}$
		2.25	—	2.38	V	$T_A = -40^\circ\text{C}$ to $+125^\circ\text{C}$
Reset Threshold Tempco		—	30	—	ppm/ $^\circ\text{C}$	
V_{DD} to Reset Delay,		—	65	—	μsec	$V_{DD} = V_{TH}$ to ($V_{TH} - 100\text{mV}$) (Note 2)
Reset Active Time Out Period		140	320	560	msec	
RESET Output Voltage Low (TCM809)	V_{OL}	—	—	0.3	V	TCM809R/S/T/Z: $V_{DD} = V_{TH}$ min, $I_{SINK} = 1.2\text{mA}$ TCM809L/M/J: $V_{DD} = V_{TH}$ min, $I_{SINK} = 3.2\text{mA}$ $V_{DD} > 1.0\text{V}$, $I_{SINK} = 50\mu\text{A}$
RESET Output Voltage High (TCM809)	V_{OH}	0.8 V_{DD}	—	—	V	TCM809R/S/T/Z: $V_{DD} > V_{TH}$ max, $I_{SOURCE} = 500\mu\text{A}$ TCM809L/M/J: $V_{DD} > V_{TH}$ max, $I_{SOURCE} = 800\mu\text{A}$
RESET Output Voltage Low (TCM810)	V_{OL}	—	—	0.3	V	TCM810R/S/T/Z: $V_{DD} = V_{TH}$ max, $I_{SINK} = 1.2\text{mA}$ TCM810L/M: $V_{DD} = V_{TH}$ max, $I_{SINK} = 3.2\text{mA}$
RESET Output Voltage High (TCM810)	V_{OH}	0.8 V_{DD}	—	—	V	$1.8 < V_{DD} < V_{TH}$ min, $I_{SOURCE} = 150\mu\text{A}$

- Note 1:** Production testing done at $T_A = +25^\circ\text{C}$, overtemperature limits ensured by QC screen.
Note 2: RESET output for **TCM809**, RESET output for **TCM810**.

2.0 TYPICAL PERFORMANCE CHARACTERISTICS

Note: The graphs and tables provided following this note are a statistical summary based on a limited number of samples and are provided for informational purposes only. The performance characteristics listed herein are not tested or guaranteed. In some graphs or tables, the data presented may be outside the specified operating range (e.g., outside specified power supply range) and therefore outside the warranted range.

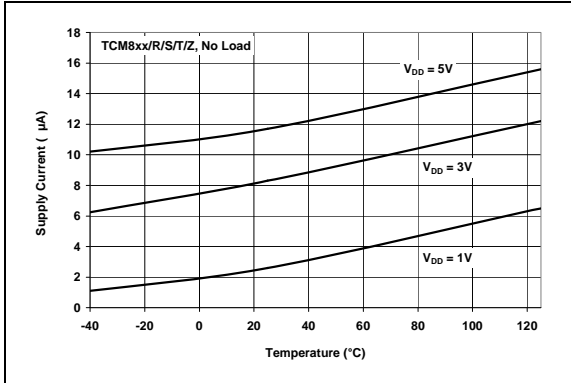

FIGURE 2-1: Supply Current vs. Temperature.

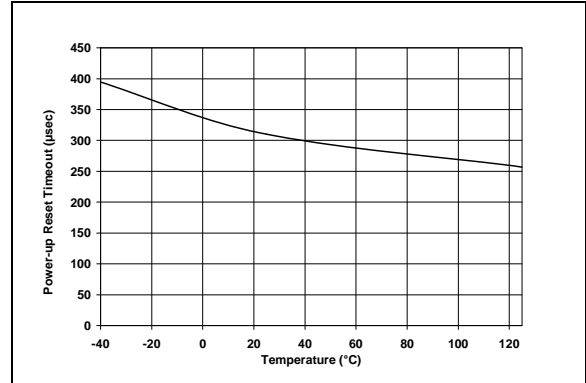

FIGURE 2-3: Power-up Reset Time Out vs. Temperature.

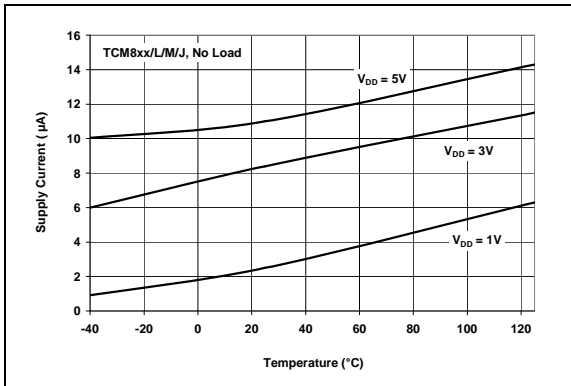

FIGURE 2-2: Supply Current vs. Temperature.

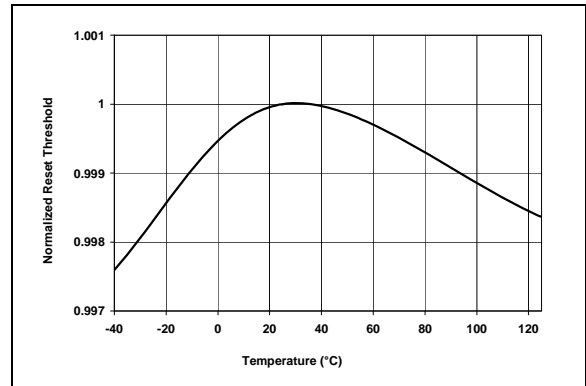

FIGURE 2-4: Normalized Reset Threshold vs. Temperature.

TCM809/TCM810

3.0 PIN DESCRIPTIONS

The descriptions of the pins are given in Table 3-1.

TABLE 3-1: PIN FUNCTION TABLE

NAME	FUNCTION
GND	Ground
$\overline{\text{RESET}}$ (TCM809)	$\overline{\text{RESET}}$ push-pull output
RESET (TCM810)	RESET push-pull output
V _{DD}	Supply voltage (+2.5V, +3.0V, +3.3V, +5.0V).

3.1 Ground (GND)

Ground terminal.

3.2 $\overline{\text{RESET}}$ Output (TCM809)

The $\overline{\text{RESET}}$ push-pull output remains low while V_{DD} is below the reset voltage threshold, and for 240 msec (140 msec min.) after V_{DD} rises above reset threshold.

3.3 RESET Output (TCM810)

The RESET push-pull output remains high while V_{DD} is below the reset voltage threshold, and for 240 msec (140 msec min.) after V_{DD} rises above reset threshold.

3.4 Supply Voltage (V_{DD})

V_{DD}: +2.5V, +3.0V, +3.3V and +5.0V

4.0 APPLICATIONS INFORMATION

4.1 V_{DD} Transient Rejection

The TCM809/TCM810 provides accurate V_{DD} monitoring and reset timing during power-up, power-down and brown-out/sag conditions. These devices also reject negative-going transients (glitches) on the power supply line. Figure 4-1 shows the maximum transient duration vs. maximum negative excursion (overdrive) for glitch rejection. Any combination of duration and overdrive that lies under the curve will not generate a reset signal.



FIGURE 4-1: Maximum Transient Duration vs. Overdrive for Glitch Rejection at +25°C.

Combinations above the curve are detected as a brown-out or power-down condition. Transient immunity can be improved by adding a capacitor in close proximity to the V_{DD} pin of the TCM809/TCM810.

4.2 $\overline{\text{RESET}}$ Signal Integrity During Power-Down

The TCM809 $\overline{\text{RESET}}$ output is valid to $V_{DD} = 1.0\text{V}$. Below this voltage the output becomes an "open circuit" and does not sink current. This means CMOS logic inputs to the microcontroller will be floating at an undetermined voltage. Most digital systems are completely shut down well above this voltage. However, in situations where $\overline{\text{RESET}}$ must be maintained valid to $V_{DD} = 0\text{V}$, a pull-down resistor must be connected from $\overline{\text{RESET}}$ to ground to discharge stray capacitances and hold the output low (Figure 4-2). This resistor value, though not critical, should be chosen such that it does not appreciably load $\overline{\text{RESET}}$ under normal operation (100 k Ω will be suitable for most applications). Similarly, a pull-up resistor to V_{DD} is required for the TCM810 to ensure a valid high $\overline{\text{RESET}}$ for V_{DD} below 1.0V.



FIGURE 4-2: The addition of R_1 at the $\overline{\text{RESET}}$ output of the TCM809 ensures that the $\overline{\text{RESET}}$ output is valid to $V_{DD} = 0\text{V}$.

TCM809/TCM810

4.3 Controllers and Processors With Bidirectional I/O Pins

Some microcontrollers have bidirectional reset pins. Depending on the current drive capability of the controller pin, an indeterminate logic level may result if there is a logic conflict. This can be avoided by adding a 4.7 k Ω resistor in series with the output of the TCM809/TCM810 (Figure 4-3). If there are other components in the system that require a reset signal, they should be buffered so as not to load the reset line. If the other components are required to follow the reset I/O of the microcontroller, the buffer should be connected as shown with the solid line.



FIGURE 4-3: Interfacing the TCM809 to a Bidirectional RESET I/O.

5.0 PACKAGING INFORMATION

5.1 Package Marking Information

3-Pin SOT-23B



Example:

Customer Specific Information Codes for:			
Part Number		TCM8xx =	
		TCM809	TCM810
TCM8xxL	ENB	J1	K1
	VNB	JZ	KZ
TCM8xxM	ENB	J2	K2
	VNB	JY	KY
TCM8xxT	ENB	J3	K3
	VNB	JX	KX
TCM8xxS	ENB	J4	K4
	VNB	JV	KV
TCM8xxR	ENB	J5	K5
	VNB	JU	KU
TCM8xxJ	ENB	J6	—
	VNB	JT	KS
TCM8xxZ	ENB	J7	K6

3-Pin SC-70



Example:

Customer Specific Information Codes for:			
Part Number		TCM8xx =	
		TCM809	TCM810
TCM8xxL	ELB	J1	—
	VLB	JZ	KZ
TCM8xxM	ELB	J2	—
	VLB	JY	KY
TCM8xxT	ELB	J3	—
	VLB	JX	KX
TCM8xxS	ELB	J4	—
	VLB	JV	KV
TCM8xxR	ELB	J5	—
	VLB	JU	KU
TCM8xxJ	ELB	J6	—
	VLB	JT	KS
TCM8xxZ	ELB	J7	—
	VLB	JS	KT

OR

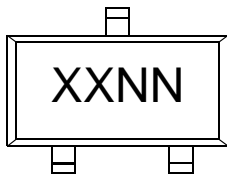

Legend: XX...X Customer-specific information*
 Y Year code (last digit of calendar year)
 YY Year code (last 2 digits of calendar year)
 WW Week code (week of January 1 is week '01')
 NNN Alphanumeric traceability code
 (e3) Pb-free JEDEC designator for Matte Tin (Sn)
 * This package is Pb-free. The Pb-free JEDEC designator (e3) can be found on the outer packaging for this package.

Note: In the event the full Microchip part number cannot be marked on one line, it will be carried over to the next line, thus limiting the number of available characters for customer-specific information.

TCM809/TCM810

3-Lead Plastic Small Outline Transistor (NB) (SOT-23)

Note: For the most current package drawings, please see the Microchip Packaging Specification located at <http://www.microchip.com/packaging>



Dimension Limits	Units	INCHES*			MILLIMETERS		
		MIN	NOM	MAX	MIN	NOM	MAX
Number of Pins	n		3			3	
Pitch	p		.038			0.96	
Outside lead pitch (basic)	p1		.076			1.92	
Overall Height	A	.035	.040	.044	0.89	1.01	1.12
Molded Package Thickness	A2	.035	.037	.040	0.88	0.95	1.02
Standoff §	A1	.000	.002	.004	0.01	0.06	0.10
Overall Width	E	.083	.093	.104	2.10	2.37	2.64
Molded Package Width	E1	.047	.051	.055	1.20	1.30	1.40
Overall Length	D	.110	.115	.120	2.80	2.92	3.04
Foot Length	L	.014	.018	.022	0.35	0.45	0.55
Foot Angle	φ	0	5	10	0	5	10
Lead Thickness	c	.004	.006	.007	0.09	0.14	0.18
Lead Width	B	.015	.017	.020	0.37	0.44	0.51
Mold Draft Angle Top	α	0	5	10	0	5	10
Mold Draft Angle Bottom	β	0	5	10	0	5	10

* Controlling Parameter

§ Significant Characteristic

Notes:

Dimensions D and E1 do not include mold flash or protrusions. Mold flash or protrusions shall not exceed .010" (0.254mm) per side.

JEDEC Equivalent: TO-236

Drawing No. C04-104

3-Lead Plastic Small Outline Transistor (LB) (SC-70)

Note: For the most current package drawings, please see the Microchip Packaging Specification located at <http://www.microchip.com/packaging>



Dimension Limits	Units	INCHES		MILLIMETERS*	
		MIN	MAX	MIN	MAX
Number of Pins		3		3	
Pitch	P	.026 BSC.		0.65 BSC.	
Outside lead pitch (basic)	p1	.051 BSC.		1.30 BSC.	
Overall Height	A	.031	.043	0.80	1.10
Molded Package Thickness	A2	.031	.039	0.80	1.00
Standoff	A1	.000	.0004	0.00	.010
Overall Width	E	.071	.094	1.80	2.40
Molded Package Width	E1	.045	.053	1.15	1.35
Overall Length	D	.071	.089	1.80	2.25
Foot Length	L	.004	.016	0.10	0.41
Lead Thickness	c	.003	.010	0.08	0.25
Lead Width	B	.006	.016	0.15	0.40
Mold Draft Angle Top	a	8°	12°	8°	12°
Mold Draft Angle Bottom	b	8°	12°	8°	12°

*Controlling Parameter

Notes:

Dimensions D and E1 do not include mold flash or protrusions. Mold flash or protrusions shall not exceed .005" (0.127mm) per side.

JEITA (EIAJ) Equivalent: SC70

Drawing No. C04-104

TCM809/TCM810

5.2 Product Tape and Reel Specifications

FIGURE 5-1: EMBOSSED CARRIER DIMENSIONS (8, 12, 16 AND 24 MM TAPE ONLY)

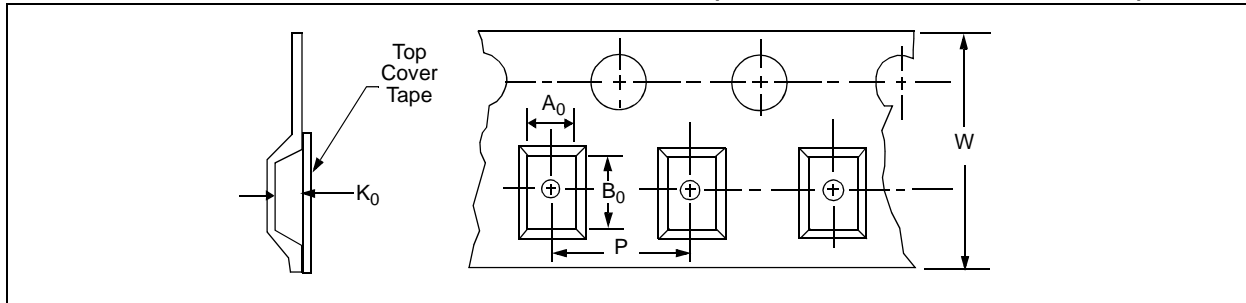
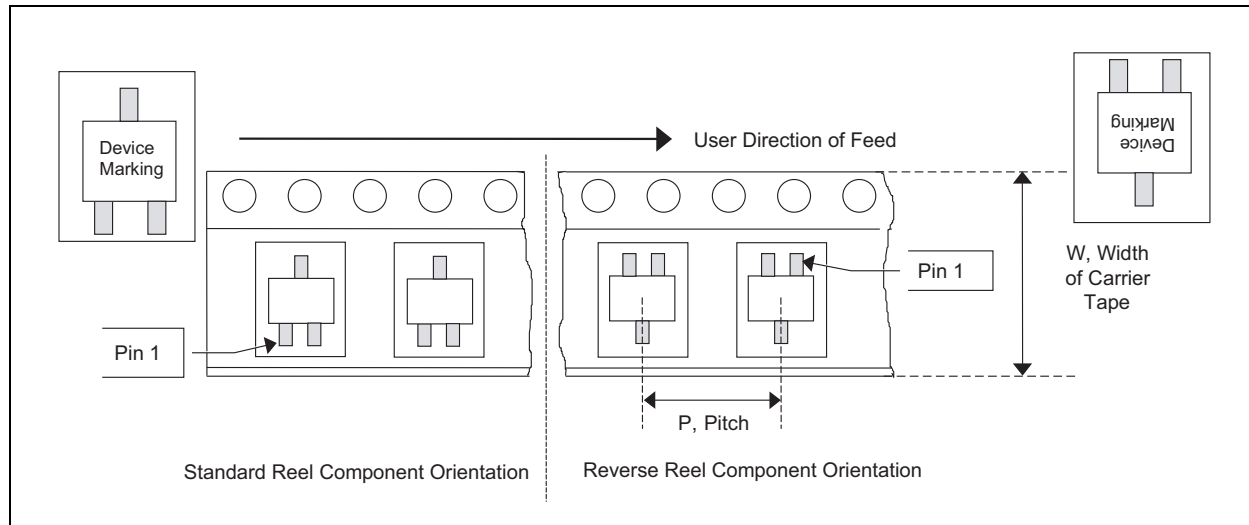

TABLE 1: CARRIER TAPE/CAVITY DIMENSIONS

Case Outline	Package Type		Carrier Dimensions		Cavity Dimensions			Output Quantity Units	Reel Diameter in mm
			W mm	P mm	A0 mm	B0 mm	K0 mm		
NB	SOT-23	3L	8	4	3.15	2.77	1.22	3000	180
LB	SC-70	3L	8	4	2.4	2.4	1.19	3000	180

FIGURE 5-2: 3-LEAD SOT-23/SC70 DEVICE TAPE AND REEL SPECIFICATIONS



APPENDIX A: REVISION HISTORY

Revision E (December 2012)

- Added a note to each package outline drawing.

Revision D (March 2005)

- Updated 6.0 “**Packaging Information**” to include old and new packaging examples.
- Applied new template and rearranged sections to be consistent with current documentation.

Revision C (April 2004)

Revision B (January 2002)

Revision A (May 2001)

Initial release of data sheet.

TCM809/TCM810

NOTES:

PRODUCT IDENTIFICATION SYSTEM

To order or obtain information, e.g., on pricing or delivery, refer to the factory or the listed sales office.

<u>PART NO.</u>	<u>X</u>	<u>X</u>	<u>XXXXX</u>	Examples:
Device	V _{DD} Reset Threshold	Temperature Range	Package	
Device: TCM809: Supervisor circuit with active-low $\overline{\text{RESET}}$ output TCM810: Supervisor circuit with active-high RESET output V _{DD} Reset Threshold: L = 4.63V M = 4.38V J = 4.00V T = 3.08V S = 2.93V R = 2.63V Z = 2.32V Temperature Range: E = -40°C to +85°C V = -40°C to +125°C Package: NB713 = SOT-23B, 3-pin (Tape and Reel) LB713 = SC-70, 3-pin (Tape and Reel)				a) TCM809LENB713: SOT-23B-3-TR, Microcontroller 4.63V Reset Monitor, -40°C to +85°C, Tape and Reel. b) TCM809LVLB713: SC-70-3-TR, Microcontroller 4.63V Reset Monitor, -40°C to +125°C, Tape and Reel. c) TCM809LVNB713: SOT-23B-3-TR, Microcontroller 4.63V Reset Monitor, -40°C to +125°C, Tape and Reel. a) TCM810MENB713: SOT-23B-3-TR, Microcontroller 4.38V Reset Monitor, -40°C to +85°C, Tape and Reel. b) TCM810RVLB713: SOT-23B-3-TR, Microcontroller 2.63V Reset Monitor, -40°C to +125°C, Tape and Reel. c) TCM810TVLB713: SC-70-3-TR, Microcontroller 4.38V Reset Monitor, -40°C to +125°C, Tape and Reel.

Sales and Support

Data Sheets

Products supported by a preliminary Data Sheet may have an errata sheet describing minor operational differences and recommended workarounds. To determine if an errata sheet exists for a particular device, please contact one of the following:

1. Your local Microchip sales office
2. The Microchip Worldwide Site (www.microchip.com)

Please specify which device, revision of silicon and Data Sheet (include Literature #) you are using.

Customer Notification System

Register on our web site (www.microchip.com) to receive the most current information on our products.

TCM809/TCM810

NOTES:

Note the following details of the code protection feature on Microchip devices:

- Microchip products meet the specification contained in their particular Microchip Data Sheet.
- Microchip believes that its family of products is one of the most secure families of its kind on the market today, when used in the intended manner and under normal conditions.
- There are dishonest and possibly illegal methods used to breach the code protection feature. All of these methods, to our knowledge, require using the Microchip products in a manner outside the operating specifications contained in Microchip's Data Sheets. Most likely, the person doing so is engaged in theft of intellectual property.
- Microchip is willing to work with the customer who is concerned about the integrity of their code.
- Neither Microchip nor any other semiconductor manufacturer can guarantee the security of their code. Code protection does not mean that we are guaranteeing the product as “unbreakable.”

Code protection is constantly evolving. We at Microchip are committed to continuously improving the code protection features of our products. Attempts to break Microchip's code protection feature may be a violation of the Digital Millennium Copyright Act. If such acts allow unauthorized access to your software or other copyrighted work, you may have a right to sue for relief under that Act.

Information contained in this publication regarding device applications and the like is provided only for your convenience and may be superseded by updates. It is your responsibility to ensure that your application meets with your specifications. MICROCHIP MAKES NO REPRESENTATIONS OR WARRANTIES OF ANY KIND WHETHER EXPRESS OR IMPLIED, WRITTEN OR ORAL, STATUTORY OR OTHERWISE, RELATED TO THE INFORMATION, INCLUDING BUT NOT LIMITED TO ITS CONDITION, QUALITY, PERFORMANCE, MERCHANTABILITY OR FITNESS FOR PURPOSE. Microchip disclaims all liability arising from this information and its use. Use of Microchip devices in life support and/or safety applications is entirely at the buyer's risk, and the buyer agrees to defend, indemnify and hold harmless Microchip from any and all damages, claims, suits, or expenses resulting from such use. No licenses are conveyed, implicitly or otherwise, under any Microchip intellectual property rights.

Trademarks

The Microchip name and logo, the Microchip logo, dsPIC, FlashFlex, KEELOQ, KEELOQ logo, MPLAB, PIC, PICmicro, PICSTART, PIC³² logo, rPIC, SST, SST Logo, SuperFlash and UNI/O are registered trademarks of Microchip Technology Incorporated in the U.S.A. and other countries.

FilterLab, Hampshire, HI-TECH C, Linear Active Thermistor, MTP, SEEVAL and The Embedded Control Solutions Company are registered trademarks of Microchip Technology Incorporated in the U.S.A.

Silicon Storage Technology is a registered trademark of Microchip Technology Inc. in other countries.

Analog-for-the-Digital Age, Application Maestro, BodyCom, chipKIT, chipKIT logo, CodeGuard, dsPICDEM, dsPICDEM.net, dsPICworks, dsSPEAK, ECAN, ECONOMONITOR, FanSense, HI-TIDE, In-Circuit Serial Programming, ICSP, Mindi, MiWi, MPASM, MPF, MPLAB Certified logo, MPLIB, MPLINK, mTouch, Omniclient Code Generation, PICC, PICC-18, PICDEM, PICDEM.net, PICkit, PICtail, REAL ICE, rLAB, Select Mode, SQI, Serial Quad I/O, Total Endurance, TSHARC, UniWinDriver, WiperLock, ZENA and Z-Scale are trademarks of Microchip Technology Incorporated in the U.S.A. and other countries.

SQTP is a service mark of Microchip Technology Incorporated in the U.S.A.

GestIC and ULPP are registered trademarks of Microchip Technology Germany II GmbH & Co. & KG, a subsidiary of Microchip Technology Inc., in other countries.

All other trademarks mentioned herein are property of their respective companies.

© 2001-2012, Microchip Technology Incorporated, Printed in the U.S.A., All Rights Reserved.

 Printed on recycled paper.

ISBN: 9781620768877

Microchip received ISO/TS-16949:2009 certification for its worldwide headquarters, design and wafer fabrication facilities in Chandler and Tempe, Arizona; Gresham, Oregon and design centers in California and India. The Company's quality system processes and procedures are for its PIC® MCUs and dsPIC® DSCs, KEELOQ® code hopping devices, Serial EEPROMs, microperipherals, nonvolatile memory and analog products. In addition, Microchip's quality system for the design and manufacture of development systems is ISO 9001:2000 certified.

QUALITY MANAGEMENT SYSTEM
CERTIFIED BY DNV
== ISO/TS 16949 ==



MICROCHIP

Worldwide Sales and Service

AMERICAS

Corporate Office
2355 West Chandler Blvd.
Chandler, AZ 85224-6199
Tel: 480-792-7200
Fax: 480-792-7277
Technical Support:
<http://www.microchip.com/support>
Web Address:
www.microchip.com

Atlanta
Duluth, GA
Tel: 678-957-9614
Fax: 678-957-1455

Boston
Westborough, MA
Tel: 774-760-0087
Fax: 774-760-0088

Chicago
Itasca, IL
Tel: 630-285-0071
Fax: 630-285-0075

Cleveland
Independence, OH
Tel: 216-447-0464
Fax: 216-447-0643

Dallas
Addison, TX
Tel: 972-818-7423
Fax: 972-818-2924

Detroit
Farmington Hills, MI
Tel: 248-538-2250
Fax: 248-538-2260

Indianapolis
Noblesville, IN
Tel: 317-773-8323
Fax: 317-773-5453

Los Angeles
Mission Viejo, CA
Tel: 949-462-9523
Fax: 949-462-9608

Santa Clara
Santa Clara, CA
Tel: 408-961-6444
Fax: 408-961-6445

Toronto
Mississauga, Ontario,
Canada
Tel: 905-673-0699
Fax: 905-673-6509

ASIA/PACIFIC

Asia Pacific Office
Suites 3707-14, 37th Floor
Tower 6, The Gateway
Harbour City, Kowloon
Hong Kong
Tel: 852-2401-1200
Fax: 852-2401-3431

Australia - Sydney
Tel: 61-2-9868-6733
Fax: 61-2-9868-6755

China - Beijing
Tel: 86-10-8569-7000
Fax: 86-10-8528-2104

China - Chengdu
Tel: 86-28-8665-5511
Fax: 86-28-8665-7889

China - Chongqing
Tel: 86-23-8980-9588
Fax: 86-23-8980-9500

China - Hangzhou
Tel: 86-571-2819-3187
Fax: 86-571-2819-3189

China - Hong Kong SAR
Tel: 852-2943-5100
Fax: 852-2401-3431

China - Nanjing
Tel: 86-25-8473-2460
Fax: 86-25-8473-2470

China - Qingdao
Tel: 86-532-8502-7355
Fax: 86-532-8502-7205

China - Shanghai
Tel: 86-21-5407-5533
Fax: 86-21-5407-5066

China - Shenyang
Tel: 86-24-2334-2829
Fax: 86-24-2334-2393

China - Shenzhen
Tel: 86-755-8864-2200
Fax: 86-755-8203-1760

China - Wuhan
Tel: 86-27-5980-5300
Fax: 86-27-5980-5118

China - Xian
Tel: 86-29-8833-7252
Fax: 86-29-8833-7256

China - Xiamen
Tel: 86-592-2388138
Fax: 86-592-2388130

China - Zhuhai
Tel: 86-756-3210040
Fax: 86-756-3210049

ASIA/PACIFIC

India - Bangalore
Tel: 91-80-3090-4444
Fax: 91-80-3090-4123

India - New Delhi
Tel: 91-11-4160-8631
Fax: 91-11-4160-8632

India - Pune
Tel: 91-20-2566-1512
Fax: 91-20-2566-1513

Japan - Osaka
Tel: 81-6-6152-7160
Fax: 81-6-6152-9310

Japan - Tokyo
Tel: 81-3-6880-3770
Fax: 81-3-6880-3771

Korea - Daegu
Tel: 82-53-744-4301
Fax: 82-53-744-4302

Korea - Seoul
Tel: 82-2-554-7200
Fax: 82-2-558-5932 or
82-2-558-5934

Malaysia - Kuala Lumpur
Tel: 60-3-6201-9857
Fax: 60-3-6201-9859

Malaysia - Penang
Tel: 60-4-227-8870
Fax: 60-4-227-4068

Philippines - Manila
Tel: 63-2-634-9065
Fax: 63-2-634-9069

Singapore
Tel: 65-6334-8870
Fax: 65-6334-8850

Taiwan - Hsin Chu
Tel: 886-3-5778-366
Fax: 886-3-5770-955

Taiwan - Kaohsiung
Tel: 886-7-213-7828
Fax: 886-7-330-9305

Taiwan - Taipei
Tel: 886-2-2508-8600
Fax: 886-2-2508-0102

Thailand - Bangkok
Tel: 66-2-694-1351
Fax: 66-2-694-1350

EUROPE

Austria - Wels
Tel: 43-7242-2244-39
Fax: 43-7242-2244-393

Denmark - Copenhagen
Tel: 45-4450-2828
Fax: 45-4485-2829

France - Paris
Tel: 33-1-69-53-63-20
Fax: 33-1-69-30-90-79

Germany - Munich
Tel: 49-89-627-144-0
Fax: 49-89-627-144-44

Italy - Milan
Tel: 39-0331-742611
Fax: 39-0331-466781

Netherlands - Drunen
Tel: 31-416-690399
Fax: 31-416-690340

Spain - Madrid
Tel: 34-91-708-08-90
Fax: 34-91-708-08-91

UK - Wokingham
Tel: 44-118-921-5869
Fax: 44-118-921-5820

11/29/12

单击下面可查看定价，库存，交付和生命周期等信息

[>>Microchip Technology](#)